

REVISIONS			
REV	DESCRIPTION	DATE	BY

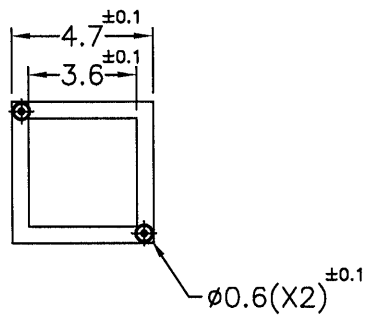

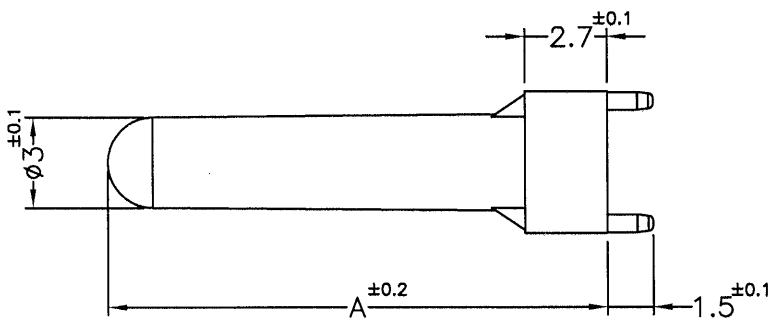

PART NO.	A
PL1-7.6V0	7.6
PL1-16.5V0	16.5

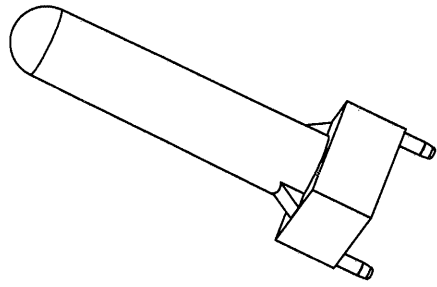
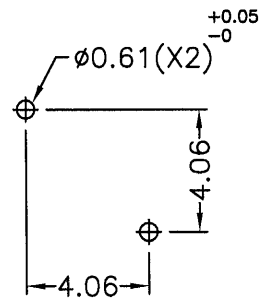

MOUNTING HOLE

NOTE:MADE OF EQUIVALENT MATERIAL.
均可使用同等材質.

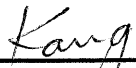
 <p>康揚企業股份有限公司 KANG YANG HARDWARE ENTERPRISE CO., LTD. 康揚塑膠(東莞)有限公司 KANG YANG PLASTIC(DONG GUAN)CO.,LTD. 康哲電腦配件(吳江)有限公司 KANG CHE COMPUTER COMPONENTS(WUJIANG) CO.,LTD.</p>				TITLE	LIGHT PIPE	SPEC. DWG.	
				MATERIAL	PC UL94V-0	DATE	2018.02.13
				FINISH		DRAWN	XIAO
				COLOR	TRANSPARENT	CHECK	
PART NUMBER	SEE ABOVE	DRAWING NUMBER	PL1-HV0	UNLESS OTHERWISE SPECIFIED TOLERANCE	SEE ABOVE	APPROVED	
SIZE	A4	SCALE	4:1	UNIT	mm	REV	A