

GaAs MMIC SMT SINGLE BALANCED MIXER, 1.7 - 3.0 GHz



Typical Applications

The HMC272AMS8 / HMC272AMS8E is ideal for:

- Up or Down Converter for PCS
- W-CDMA
- 2.4 GHz ISM
- MMDS

Features

- RoHS Compliant Product
- Ultra Small Package: MSOP8
- LO / RF Isolation: 32 dB
- Input IP3: +20 dBm

Functional Diagram

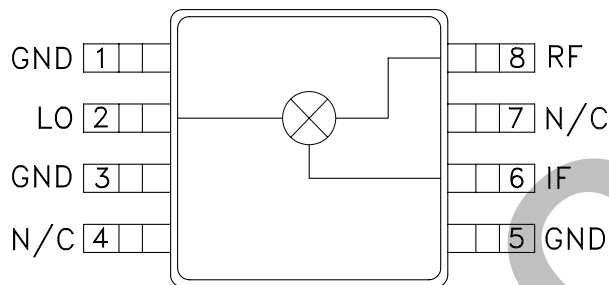

General Description

The HMC272AMS8 & HMC272AMS8E are general purpose ultra miniature single balanced mixers in 8 lead plastic surface mount Mini Small Outline Packages (MSOP). This passive MMIC mixer is constructed of GaAs Schottky diodes and a novel planar transformer balun on the chip. The RF port is balanced via the MMIC balun while the LO port is connected directly to the diodes. The consistent MMIC performance will improve system operation and assure regulatory compliance.

Electrical Specifications, $T_A = +25^\circ C$, As a Function of IF Frequency

Parameter	LO = +10 dBm IF = 100 MHz			LO = +10 dBm IF = 400 MHz			Units
	Min.	Typ.	Max.	Min.	Typ.	Max.	
Frequency Range, RF & LO	2 - 3			1.7 - 2.8			GHz
Frequency Range, IF	DC - 0.8			DC - 0.8			GHz
Conversion Loss		9	10.5		9	11	dB
Noise Figure (SSB)		9	10.5		9	11	dB
LO to RF Isolation	22	30		24	32		dB
LO to IF Isolation	12	20		11	18		dB
IP3 (Input)	17	21		16	20		dBm
1 dB Compression (Input)	8	11		7	10		dBm



GaAs MMIC SMT SINGLE BALANCED MIXER, 1.7 - 3.0 GHz

Conversion Gain vs. Temperature @ LO = +10 dBm

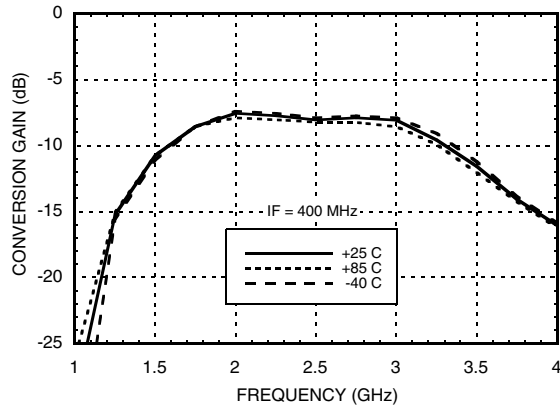

Isolation @ LO = +10 dBm

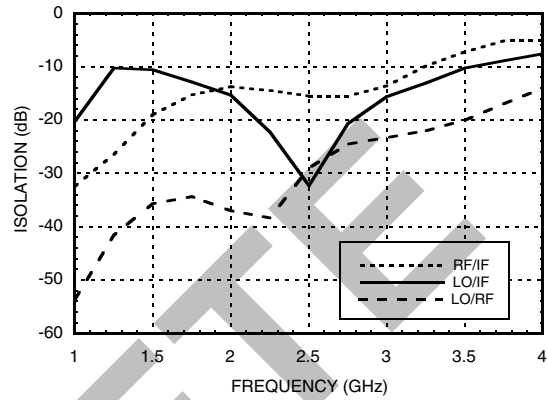

Conversion Gain vs. LO Drive

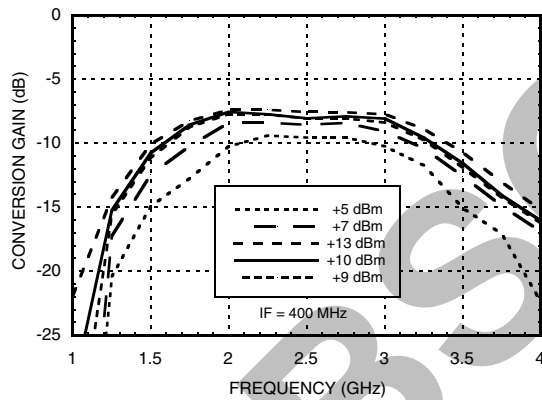

Return Loss @ LO = +10 dBm

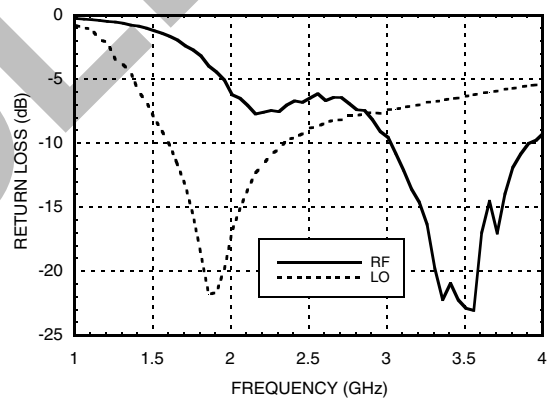

Conversion Gain vs. IF Frequency

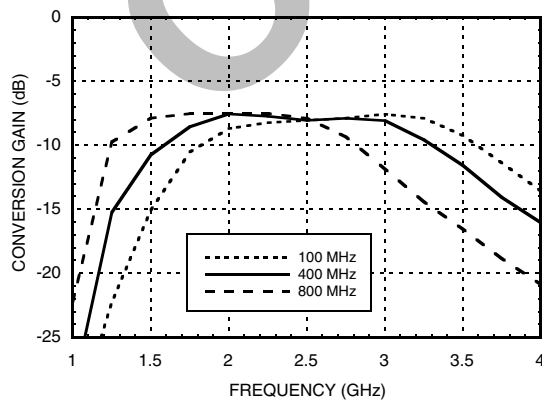

IF Bandwidth @ LO = +10 dBm vs. Conversion Gain & Return Loss

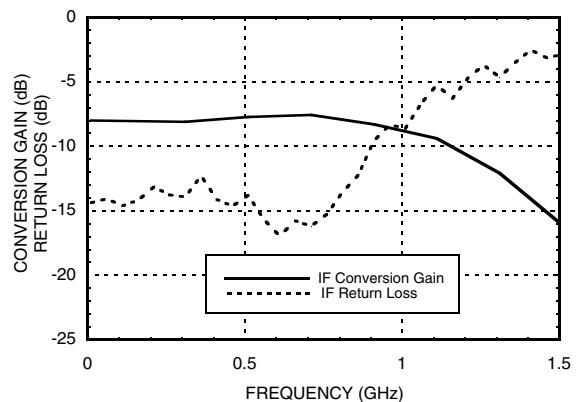

Information furnished by Analog Devices is believed to be accurate and reliable. However, no responsibility is assumed by Analog Devices for its use, nor for any infringements of patents or other rights of third parties that may result from its use. Specifications subject to change without notice. No license is granted by implication or otherwise under any patent or patent rights of Analog Devices. Trademarks and registered trademarks are the property of their respective owners.

For price, delivery, and to place orders: Analog Devices, Inc., One Technology Way, P.O. Box 9106, Norwood, MA 02062-9106 Phone: 781-329-4700 • Order online at www.analog.com Application Support: Phone: 1-800-ANALOG-D



**GaAs MMIC SMT SINGLE
BALANCED MIXER, 1.7 - 3.0 GHz**

Input IP3 vs. LO Drive

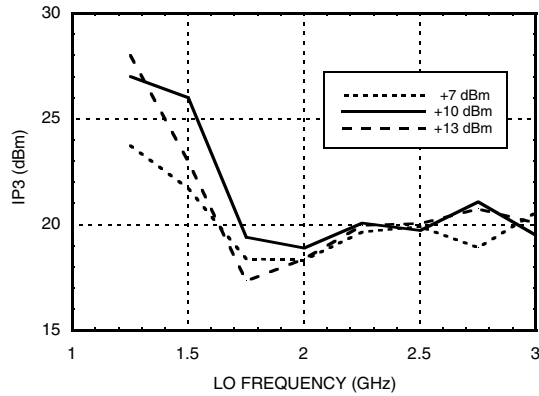

**Input IP3 vs.
Temperature @ LO = +10 dBm**

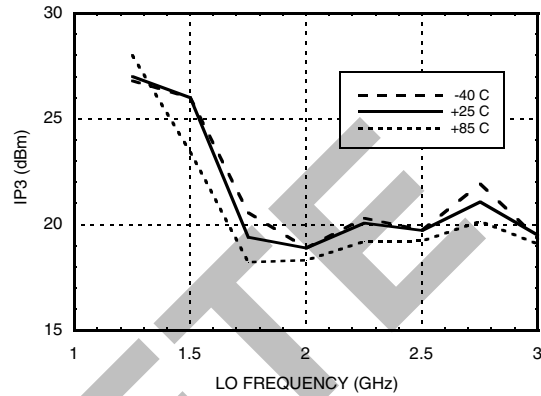

Input IP2 vs. LO Drive

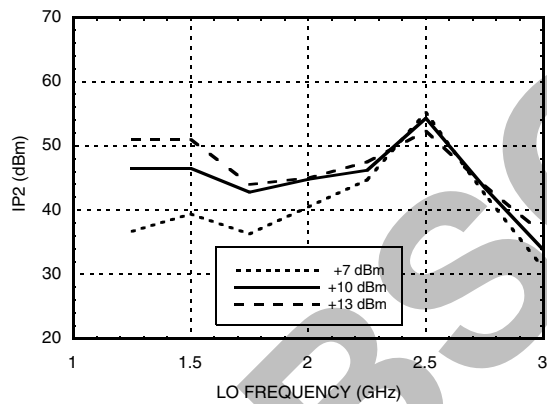

**P1dB vs.
Temperature @ LO = +10 dBm**

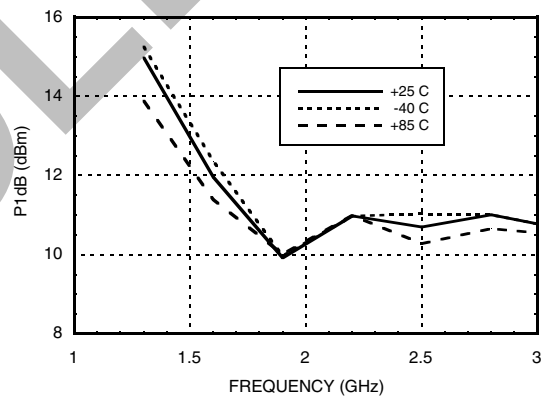



GaAs MMIC SMT SINGLE BALANCED MIXER, 1.7 - 3.0 GHz

MxN Spurious Outputs

mRF	nLO				
	0	1	2	3	4
0	xx	-11	-6	5	19
1	7	0	37	27	38
2	53	64	62	46	72
3	83	>85	>85	>85	>85
4	>85	>85	>85	>85	>85

RF = 2.6 GHz @ -10 dBm
LO = 2.2 GHz @ +13 dBm
All values in dBc relative to the IF

Harmonics of LO

LO Frequency (GHz)	nLO Spur at RF Port			
	1	2	3	4
1.5	37	14	36	41
1.7	35	12	37	48
1.9	35	13	43	49
2.1	43	16	42	49
2.3	36	19	37	49
2.5	29	23	36	50

LO = +10 dBm
Values in dBc below input LO level measured at the RF port.

Absolute Maximum Ratings

RF / IF Input	+13 dBm
LO Drive	+27 dBm
Storage Temperature	-65 to +150 °C
Operating Temperature	-40 to +85 °C
ESD Sensitivity (HBM)	Class 1A



ELECTROSTATIC SENSITIVE DEVICE
OBSERVE HANDLING PRECAUTIONS



**GaAs MMIC SMT SINGLE
BALANCED MIXER, 1.7 - 3.0 GHz**

Outline Drawing

10

MIXERS - SINGLE & DOUBLE BALANCED - SMT

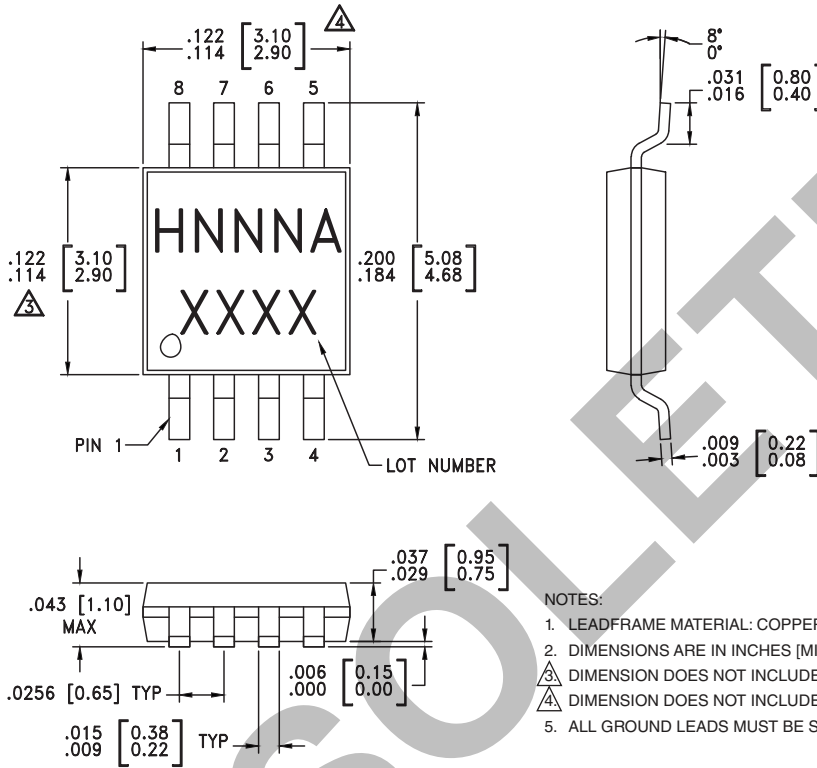

- NOTES:
1. LEADFRAME MATERIAL: COPPER ALLOY
 2. DIMENSIONS ARE IN INCHES [MILLIMETERS].
 3. DIMENSION DOES NOT INCLUDE MOLDFLASH OF 0.15mm PER SIDE.
 4. DIMENSION DOES NOT INCLUDE MOLDFLASH OF 0.25mm PER SIDE.
 5. ALL GROUND LEADS MUST BE SOLDERED TO PCB RF GROUND.

Package Information

Part Number	Package Body Material	Lead Finish	MSL Rating	Package Marking ^[3]
HMC272AMS8	Low Stress Injection Molded Plastic	Sn/Pb Solder	MSL1 ^[1]	H272A XXXX
HMC272AMS8E	RoHS-compliant Low Stress Injection Molded Plastic	100% matte Sn	MSL1 ^[2]	H272A XXXX

[1] Max peak reflow temperature of 235 °C
 [2] Max peak reflow temperature of 260 °C
 [3] 4-Digit lot number XXXX



Evaluation Circuit Board

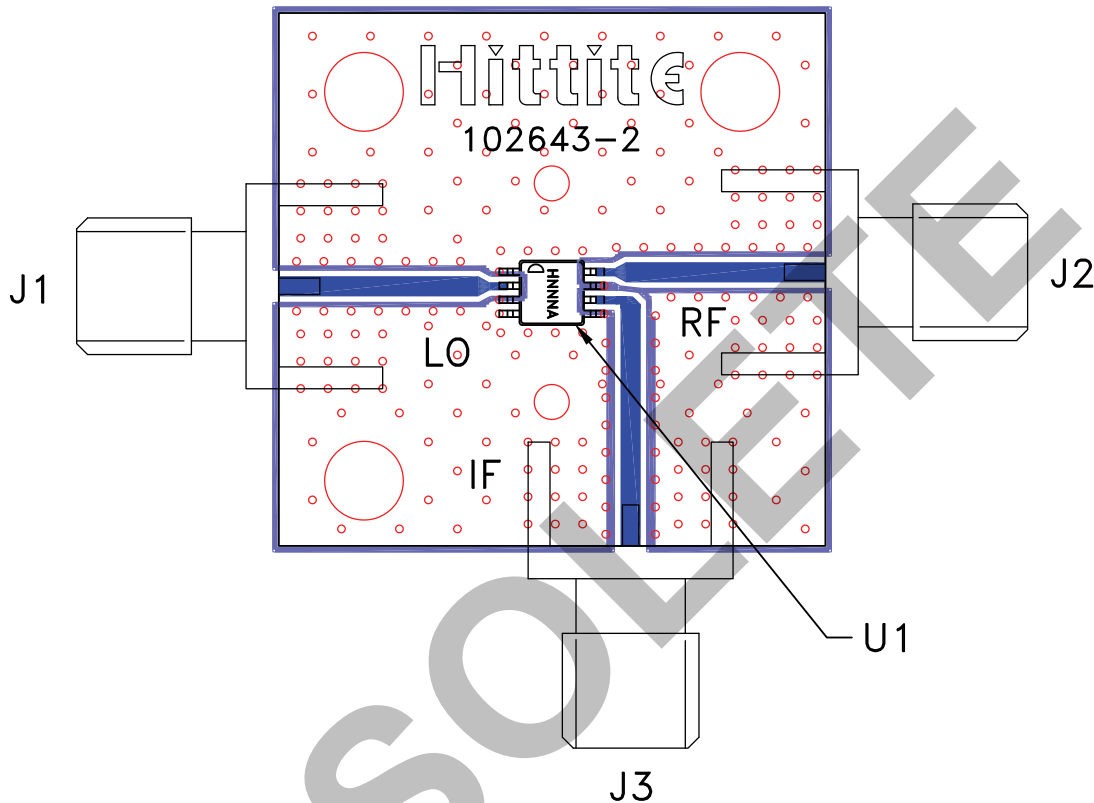

List of Materials for Evaluation PCB 102781 [1]

Item	Description
J1 - J3	PCB Mount SMA RF Connector
U1	HMC272AMS8 / HMC272AMS8E Mixer
PCB [2]	102643 Evaluation Board

[1] Reference this number when ordering complete evaluation PCB

[2] Circuit Board Material: Rogers 4350

The circuit board used in the application should use RF circuit design techniques. Signal lines should have 50 Ohm impedance while the package ground leads and exposed paddle should be connected directly to the ground plane similar to that shown. A sufficient number of via holes should be used to connect the top and bottom ground planes. The evaluation circuit board shown is available from Hittite upon request.