

Sales Outline Drawing

Specifications:

Sound Level Category	Loud
Mode of Operation	Fast Pulse @ 10 PPS
Voltage Rating	7 to 14 VDC
Frequency	2100-5800 Hz Typical
Loudness @ 1 FT	85 to 95 dB(A) Typ.
Current Draw	50mA MAX
Housing Material	Valox (UL94V-0), Color: Black
Storage Temperature	-40° to +80° C
Operating Temperature	-40° to +65° C
Weight (Typical)	4.0g
Options	Please contact factory.

Dimensions: Inches (mm)

ROHS Compliant

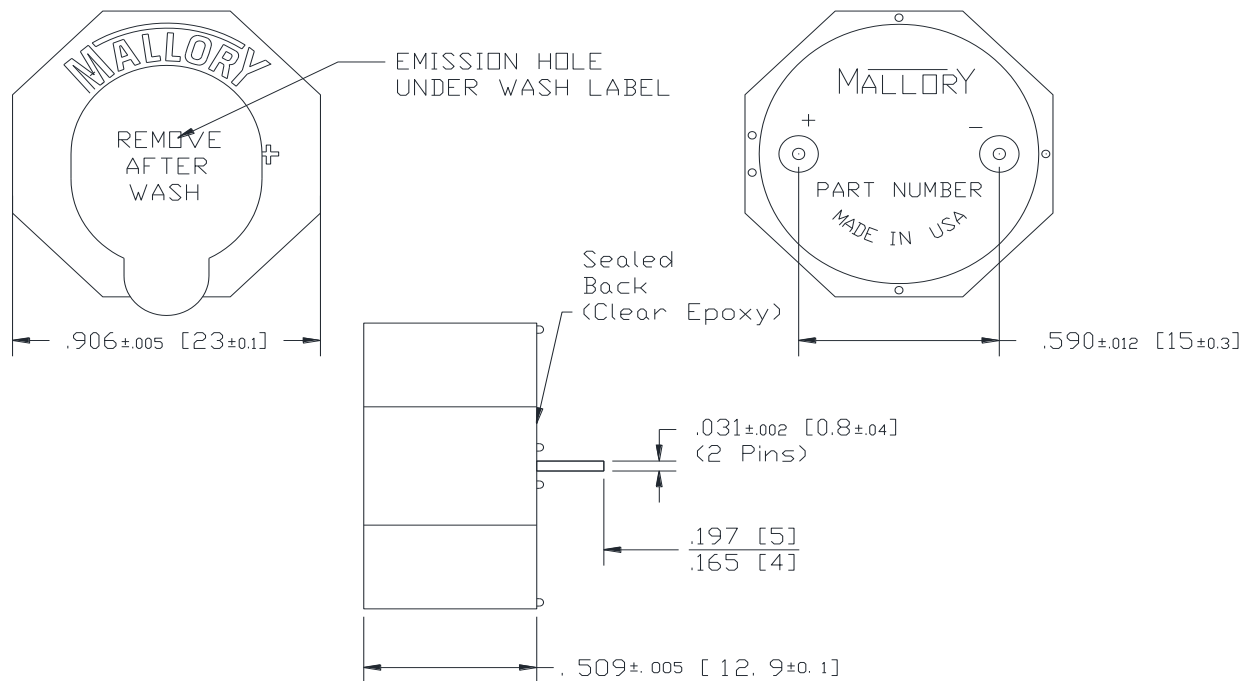

NOTE A:
TERMINALS - .031" DIA. NICKEL/TIN COATED BRASS.

NOTE B:
MOUNTING- INSERT INTO PRINTED CIRCUIT BOARD AND HAND OR MACHINE SOLDER. UNITS ARE SUITABLE FOR WAVE SOLDERING AND AQUEOUS WASH WHEN THE EMISSION HOLE IS COVERED WITH A WASH LABEL. RECOMMENDED MAXIMUM TEMPERATURE AND TIME DURATION FOR WAVE SOLDERING IS +270°C AND 3 SECONDS RESPECTIVELY.

NOTE C:
PART NUMBER - FOR SEALED MODELS WHICH INCLUDE A WASH LABEL, THE PART NUMBER ENDS WITH THE SUFFIX "SR". THE LETTER "S" IS FOR ORDERING PURPOSES ONLY AND WILL NOT BE LISTED ON THE PART ITSELF.