

TPS54335A Step-Down Converter Evaluation Module

User's Guide



ABSTRACT

This user's guide contains background information for the TPS54335A as well as support documentation for the TPS54335AEVM-010 evaluation module (BSR010-001). Also included are the performance specifications, the schematic, and the bill of materials for the TPS54335AEVM-010.

Table of Contents

1 Introduction	3
1.1 Background.....	3
1.2 Performance Specification Summary.....	3
1.3 Modifications.....	4
2 Test Setup and Results	5
2.1 Input/Output Connections.....	5
2.2 Efficiency.....	6
2.3 Output Voltage Load Regulation.....	7
2.4 Output Voltage Line Regulation.....	7
2.5 Load Transients.....	8
2.6 Loop Characteristics.....	8
2.7 Output Voltage Ripple.....	9
2.8 Input Voltage Ripple.....	10
2.9 Powering Up.....	11
2.10 Powering Down.....	12
3 Board Layout	13
3.1 Layout.....	13
4 Schematic and Bill of Materials	15
4.1 Schematic.....	16
4.2 Bill of Materials.....	17
5 Revision History	18

List of Figures

Figure 2-1. TPS54335AEVM-010 Efficiency.....	6
Figure 2-2. TPS54335AEVM-010 Low Current Efficiency.....	6
Figure 2-3. TPS54335AEVM-010 Load Regulation.....	7
Figure 2-4. TPS54335AEVM-010 Line Regulation.....	7
Figure 2-5. TPS54335AEVM-010 Transient Response.....	8
Figure 2-6. TPS54335AEVM-010 Loop Response.....	8
Figure 2-7. TPS54335AEVM-010 Output Ripple, $I_{OUT} = 3\text{ A}$	9
Figure 2-8. TPS54335AEVM-010 Output Ripple, $I_{OUT} = 100\text{ mA}$	9
Figure 2-9. TPS54335AEVM-010 Output Ripple, $I_{OUT} = 0\text{ A}$	10
Figure 2-10. TPS54335AEVM-010 Input Ripple.....	10
Figure 2-11. TPS54335AEVM-010 Start-Up Relative to V_{IN}	11
Figure 2-12. TPS54335AEVM-010 Start-up Relative to Enable.....	11
Figure 2-13. TPS54335AEVM-010 Shut-down Relative to V_{IN}	12
Figure 2-14. TPS54335AEVM-010 Shut-down Relative to EN.....	12
Figure 3-1. TPS54335AEVM-010 Top-Side Assembly.....	13
Figure 3-2. TPS54335AEVM-010 Top-Side Layout.....	14
Figure 3-3. TPS54335AEVM-010 Bottom-Side Layout.....	14
Figure 4-1. TPS54335AEVM-010 Schematic.....	16

List of Tables

Table 1-1. Input Voltage and Output Current Summary.....	3
Table 1-2. TPS54335AEVM-010 Performance Specification Summary.....	3
Table 1-3. Output Voltages Available.....	4
Table 2-1. EVM Connectors and Test Points.....	5
Table 4-1. TPS54335AEVM-010 Bill of Materials.....	17

Trademarks

All trademarks are the property of their respective owners.

1 Introduction

This user's guide contains background information for the TPS54335A as well as support documentation for the TPS54335AEVM-010 evaluation module (BSR010-001). Also included are the performance specifications, the schematic, and the bill of materials for the TPS54335AEVM-010.

1.1 Background

The TPS54335A dc/dc converter is designed to provide up to a 3-A output from an input voltage source of 4.5 V to 28 V. Rated input voltage and output current range for the evaluation module are given in [Table 1-1](#). This evaluation module is designed to demonstrate the small printed-circuit-board areas that may be achieved when designing with the TPS54335A regulator. The switching frequency is externally set at a nominal 340 kHz. The high-side and low-side MOSFETs are incorporated inside the TPS54335A package along with the gate-drive circuitry. The low drain-to-source on resistance of the MOSFETs allow the TPS54335A to achieve high efficiencies and helps keep the junction temperature low at high output currents. The compensation components are external to the integrated circuit (IC), and an external divider allows for an adjustable output voltage. Additionally, the TPS54335A provides an adjustable undervoltage lockout input. The absolute maximum input voltage is 30 V for the TPS54335AEVM-010.

Table 1-1. Input Voltage and Output Current Summary

EVM	INPUT VOLTAGE RANGE	OUTPUT CURRENT RANGE
TPS54335AEVM-010	$V_{IN} = 8\text{ V to }28\text{ V}$	0 A to 3 A

1.2 Performance Specification Summary

A summary of the TPS54335AEVM-010 performance specifications is provided in [Table 1-2](#). Specifications are given for an input voltage of $V_{IN} = 24\text{ V}$ and an output voltage of 5.0 V, unless otherwise specified. The TPS54335AEVM-010 is designed and tested for $V_{IN} = 8\text{ V to }28\text{ V}$. The ambient temperature is 25°C for all measurements, unless otherwise noted.

Table 1-2. TPS54335AEVM-010 Performance Specification Summary

SPECIFICATION	TEST CONDITIONS	MIN	TYP	MAX	UNIT	
V_{IN} operating voltage range		8	24	28	V	
V_{IN} start voltage			7.12		V	
V_{IN} stop voltage			6.12		V	
Output voltage set point			5		V	
Output current range	$V_{IN} = 8\text{ V to }28\text{ V}$	0		3	A	
Line regulation	$I_O = 1.5\text{ A}, V_{IN} = 8\text{ V to }28\text{ V}$		±0.05%			
Load regulation	$V_{IN} = 24\text{ V}, I_O = 0\text{ A to }3\text{ A}$		±0.15%			
Load transient response	$I_O = 0.75\text{ A to }2.25\text{ A}$	Voltage change	-190		mV	
		Recovery time		150	µs	
	$I_O = 2.25\text{ A to }0.75\text{ A}$	Voltage change		190		mV
		Recovery time		150		µs
Loop bandwidth	$V_{IN} = 24\text{ V}, I_O = 1.5\text{ A}$		31.6		kHz	
Phase margin	$V_{IN} = 24\text{ V}, I_O = 1.5\text{ A}$		61		°	
Input ripple voltage	$I_O = 3\text{ A}$		400		mV _{PP}	
Output ripple voltage	$I_O = 3\text{ A}$		<30		mV _{PP}	
Output rise time			2		ms	
Operating frequency			340		kHz	
Maximum efficiency	TPS54335AEVM-010, $V_{IN} = 8\text{ V}, I_O = 0.7\text{ A}$		96.5%			

1.3 Modifications

These evaluation modules are designed to provide access to the features of the TPS54335A. Some modifications can be made to this module.

1.3.1 Output Voltage Set Point

The voltage divider, R7 and R8, is used to set the output voltage. To change the output voltage of the EVM, it is necessary to change the value of resistor R8. Changing the value of R8 can change the output voltage above 0.8 V. The value of R8 for a specific output voltage can be calculated using [Equation 1](#). Use 100 kΩ for R7.

$$R8 = \frac{R7 \times 0.8 \text{ V}}{V_{\text{OUT}} - 0.8 \text{ V}} \quad (1)$$

[Table 1-3](#) lists the R9 and R10 values for some common output voltages. Note that V_{IN} must be in a range so that the minimum on-time is greater than 145 ns, and the maximum duty cycle is less than 100%. The values given in [Table 1-3](#) are standard values, not the exact value calculated using [Equation 1](#).

Table 1-3. Output Voltages Available

OUTPUT VOLTAGE (V)	R7 VALUE (kΩ)	R8 VALUE (kΩ)
1.2	100	200
1.8	100	80.6
2.5	100	47.5
3.3	100	32.4
5.0	100	19.1

1.3.2 Adjustable UVLO

The under voltage lock out (UVLO) can be adjusted externally using R1 and R2. The EVM is set for a start voltage of 7.12 V and a stop voltage of 6.12 V using R1 = 220 kΩ and R2 = 43.2 kΩ. Use [Equation 2](#) and [Equation 3](#) to calculate required resistor values for different start and stop voltages.

$$R1 = \frac{V_{\text{START}} \left(\frac{V_{\text{ENFALLING}}}{V_{\text{ENRISING}}} \right) - V_{\text{STOP}}}{I_p \left(1 - \frac{V_{\text{ENFALLING}}}{V_{\text{ENRISING}}} \right) + I_h} \quad (2)$$

$$R2 = \frac{R1 \times V_{\text{ENFALLING}}}{V_{\text{STOP}} - V_{\text{ENFALLING}} + R1(I_p + I_h)} \quad (3)$$

$I_p = 1.15 \mu\text{A}$, $I_h = 3.3 \mu\text{A}$, $V_{\text{ENFALLING}} = 1.17 \text{ V}$ and $V_{\text{ENRISING}} = 1.21 \text{ V}$

2 Test Setup and Results

This section describes how to properly connect, set up, and use the TPS54335AEVM-010 evaluation module. The section also includes test results typical for the evaluation module and covers efficiency, output voltage regulation, load transients, loop response, output ripple, input ripple, and start-up.

2.1 Input/Output Connections

The TPS54335AEVM-010 is provided with input/output connectors and test points as shown in [Table 2-1](#). A power supply capable of supplying 2 A must be connected to J1 through a pair of 20-AWG wires. The load must be connected to J4 through a pair of 20-AWG wires. The maximum load current capability must be at least 4 A to use the full capability of this EVM. Wire lengths must be minimized to reduce losses in the wires. Test-point TP1 provides a place to monitor the V_{IN} input voltages with TP2 providing a convenient ground reference. TP6 is used to monitor the output voltage with TP7 as the ground reference.

Table 2-1. EVM Connectors and Test Points

Reference Designator	Function
J1	V_{IN} (see Table 1-1 for V_{IN} range).
J2	V_{OUT} , 5 V at 3 A maximum.
JP1	2-pin header for enable. Connect EN to ground to disable, open to enable.
TP1	V_{IN} test point at V_{IN} connector.
TP2	GND test point at V_{IN} .
TP3	Slow start monitor test point for TPS54336A. Do not use for TPS54335A.
TP4	PH test point
TP5	Test point between voltage divider network and output. Used for loop response measurements.
TP6	Output voltage test point at OUT connector.
TP7	GND test point at OUT connector.

2.2 Efficiency

The efficiency of this EVM peaks at a load current of about 0.5 A – 1 A, and then decreases as the load current increases towards full load. [Figure 2-1](#) shows the efficiency for the TPS54335AEVM-010 at an ambient temperature of 25°C.

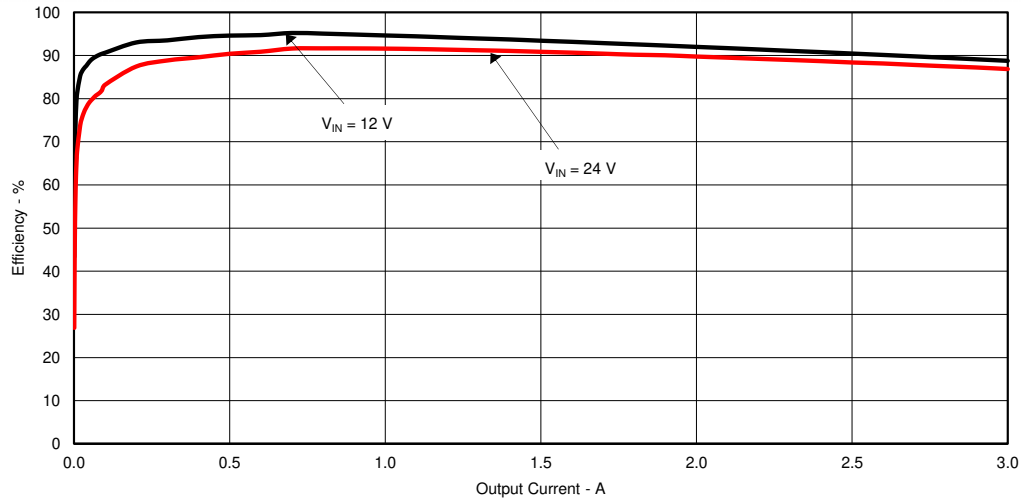

Figure 2-1. TPS54335AEVM-010 Efficiency

[Figure 2-2](#) shows the efficiency for the TPS54335AEVM-010 on a semi-log scale to better show light load efficiency. The ambient temperature is 25°C.

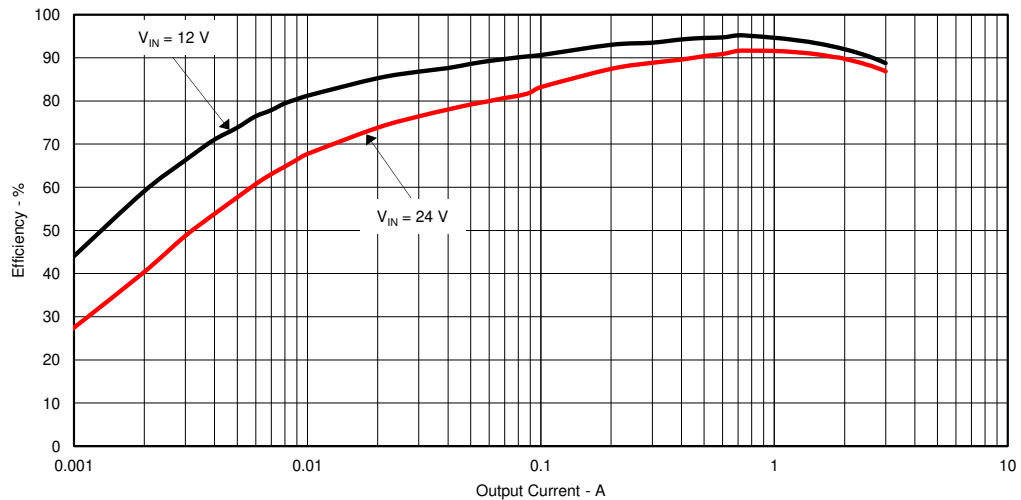

Figure 2-2. TPS54335AEVM-010 Low Current Efficiency

The efficiency may be lower at higher ambient temperatures, due to temperature variation in the drain-to-source resistance of the internal MOSFET.

2.3 Output Voltage Load Regulation

Figure 2-3 shows the load regulation for the TPS54335AEVM-010.

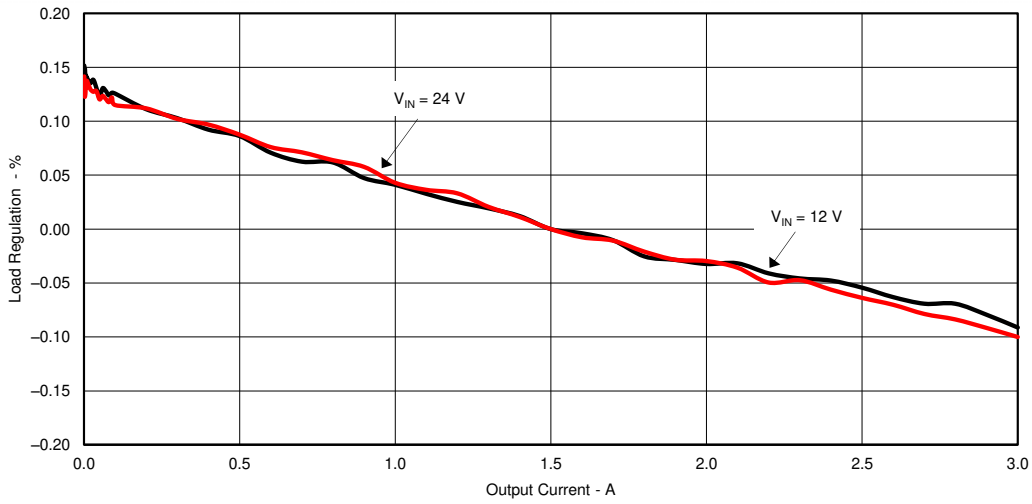

Figure 2-3. TPS54335AEVM-010 Load Regulation

Measurements are given for an ambient temperature of 25°C.

2.4 Output Voltage Line Regulation

Figure 2-4 shows the line regulation for the TPS54335AEVM-010.

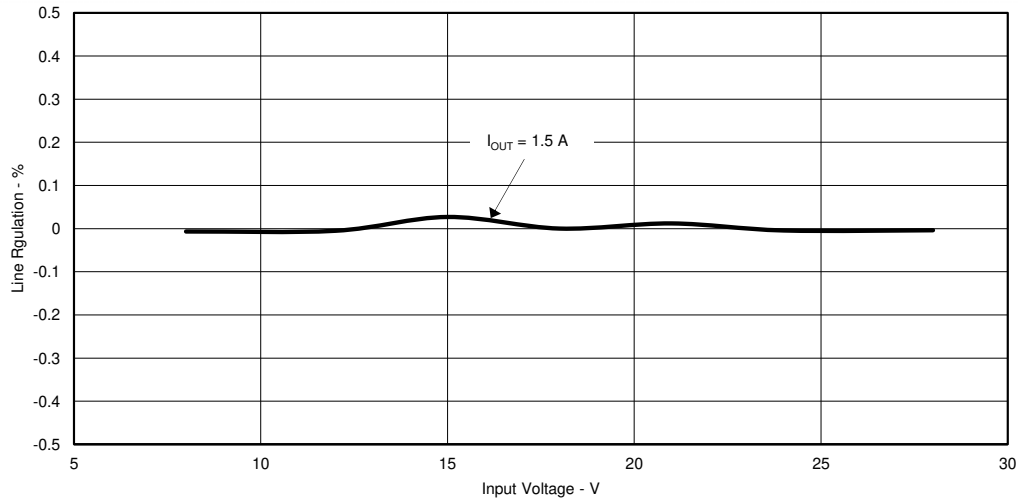

Figure 2-4. TPS54335AEVM-010 Line Regulation

2.5 Load Transients

Figure 2-5 shows the TPS54335AEVM-010 response to load transients. The current step is from 25% to 75% of maximum rated load at 24-V input. Total peak-to-peak voltage variation is as shown, including ripple and noise on the output.

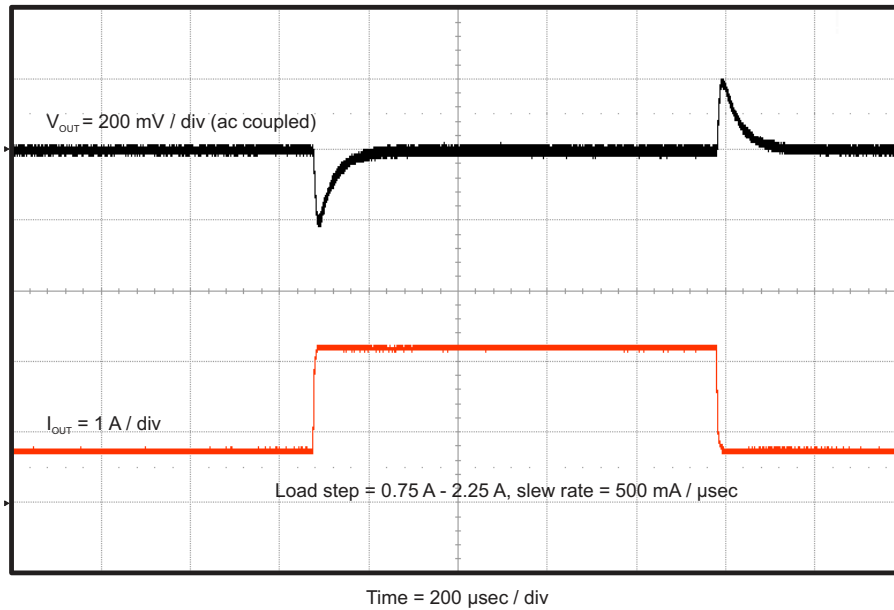

Figure 2-5. TPS54335AEVM-010 Transient Response

2.6 Loop Characteristics

Figure 2-6 shows the TPS54335AEVM-010 loop-response characteristics. Gain and phase plots are shown for V_{IN} voltage of 24 V. Load current for the measurement is 1.5 A.

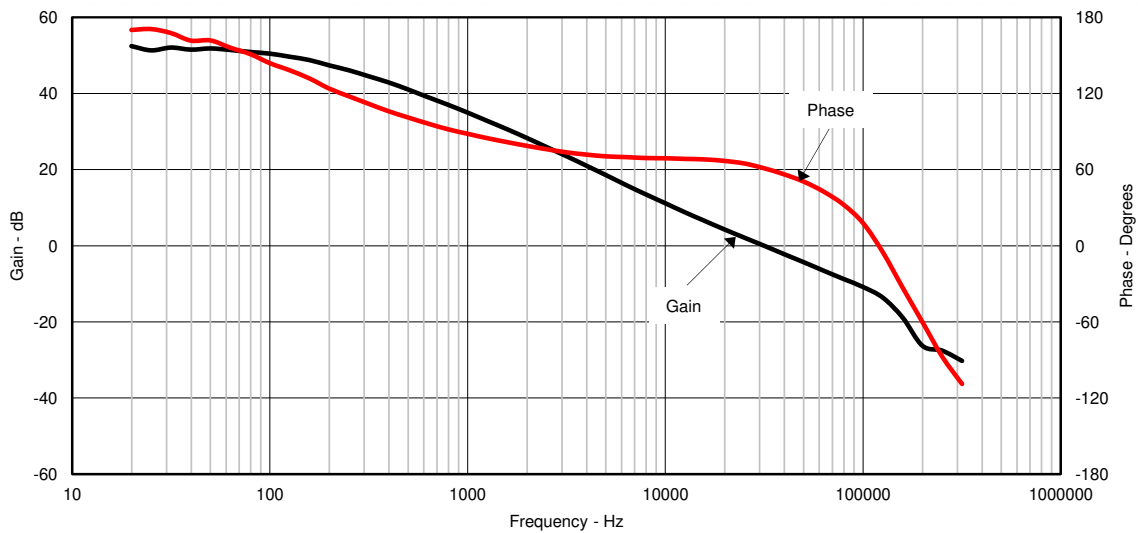

Figure 2-6. TPS54335AEVM-010 Loop Response

2.7 Output Voltage Ripple

Figure 2-7, Figure 2-8, and Figure 2-9 show the TPS54335AEVM-010 output voltage ripple for full load, light load, and skip mode operation. $V_{IN} = 24\text{ V}$. The output The ripple voltage is measured directly across the output capacitors.

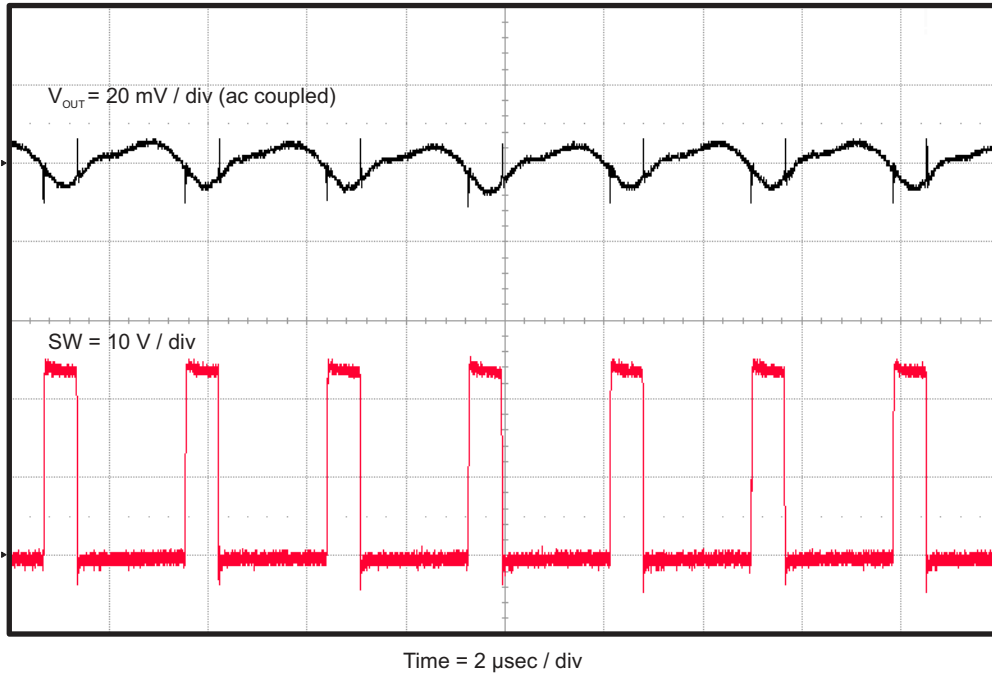

Figure 2-7. TPS54335AEVM-010 Output Ripple, $I_{OUT} = 3\text{ A}$

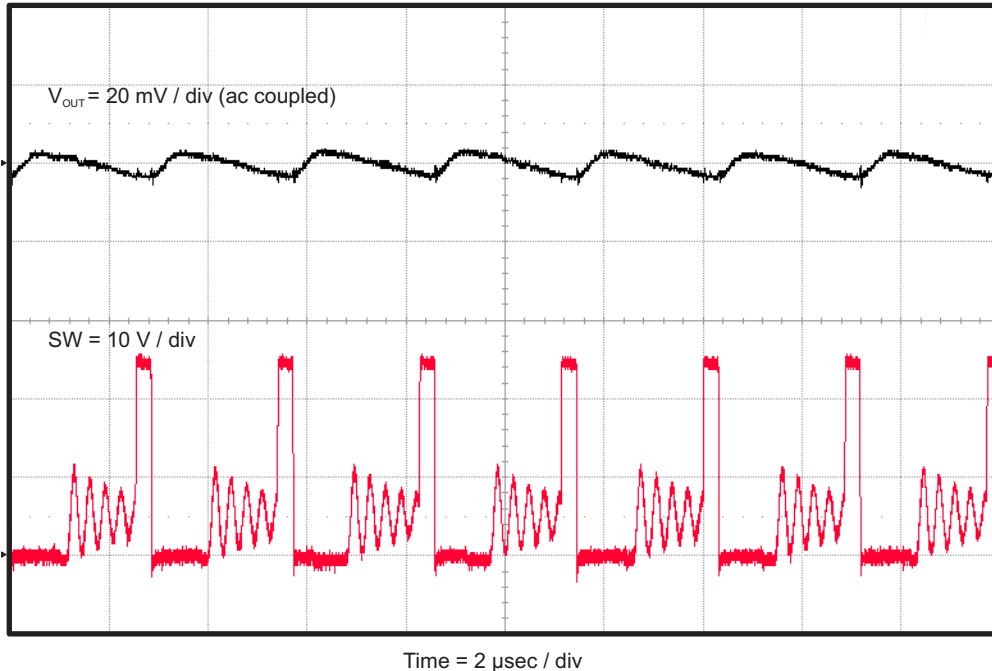

Figure 2-8. TPS54335AEVM-010 Output Ripple, $I_{OUT} = 100\text{ mA}$

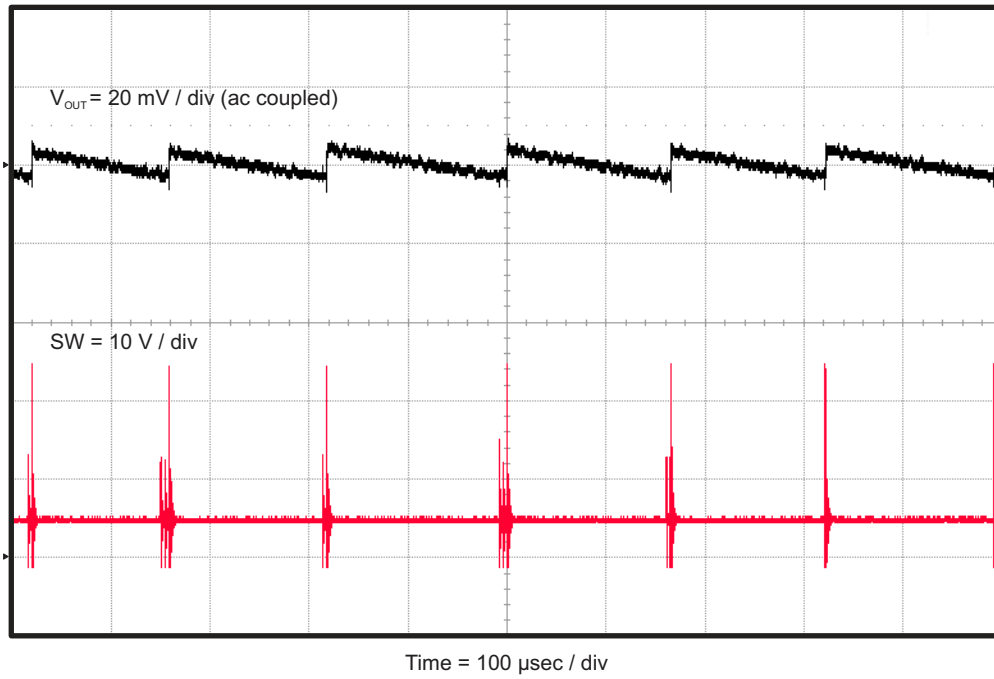

Figure 2-9. TPS54335AEVM-010 Output Ripple, $I_{OUT} = 0 \text{ A}$

2.8 Input Voltage Ripple

Figure 2-10 shows the TPS54335AEVM-010 input voltage ripple. The output current is the rated full load of 3 A and $V_{IN} = 24 \text{ V}$. The ripple voltage is measured directly across the input capacitors.

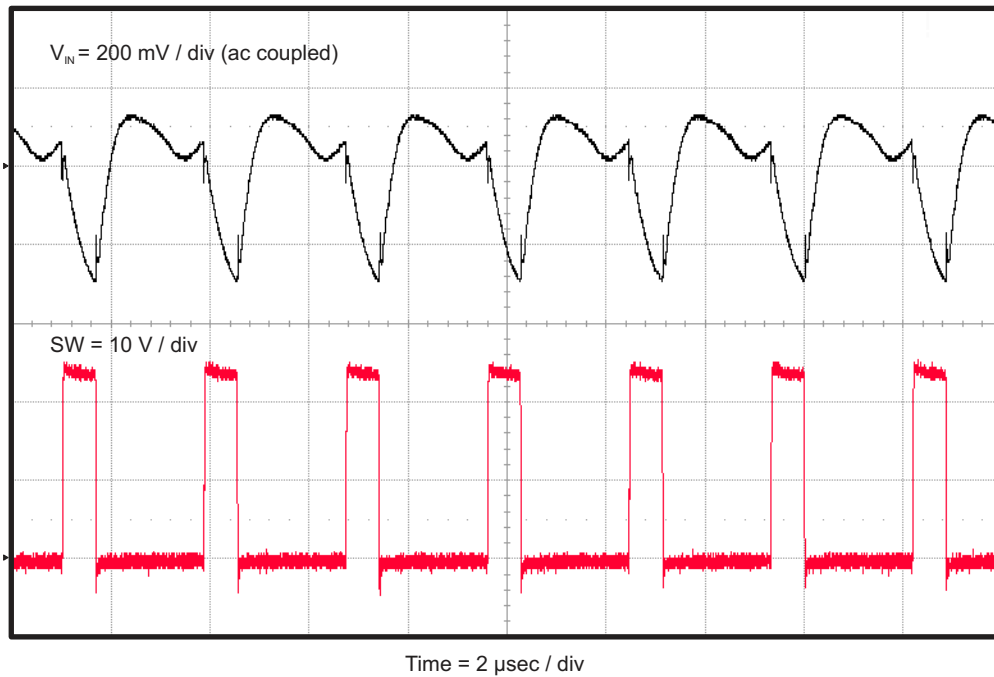

Figure 2-10. TPS54335AEVM-010 Input Ripple

2.9 Powering Up

Figure 2-11 and Figure 2-12 show the start-up waveforms for the TPS54335AEVM-010. In Figure 2-11, the output voltage ramps up as soon as the input voltage reaches the UVLO threshold as set by the R1 and R2 resistor divider network. In Figure 2-12, the input voltage is initially applied and the output is inhibited by using a jumper at JP1 to tie EN to GND. When the jumper is removed, EN is released. When the EN voltage reaches the enable-threshold voltage, the start-up sequence begins and the output voltage ramps up to the externally set value of 5 V. The input voltage for these plots is 24 V and the load is 5 Ω .

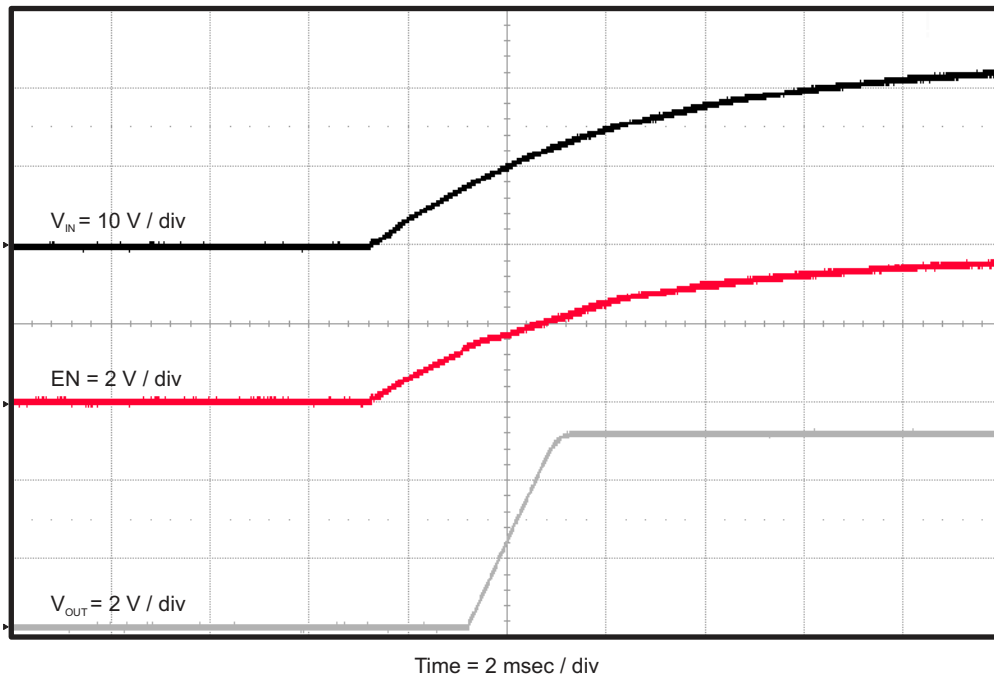

Figure 2-11. TPS54335AEVM-010 Start-Up Relative to V_{IN}

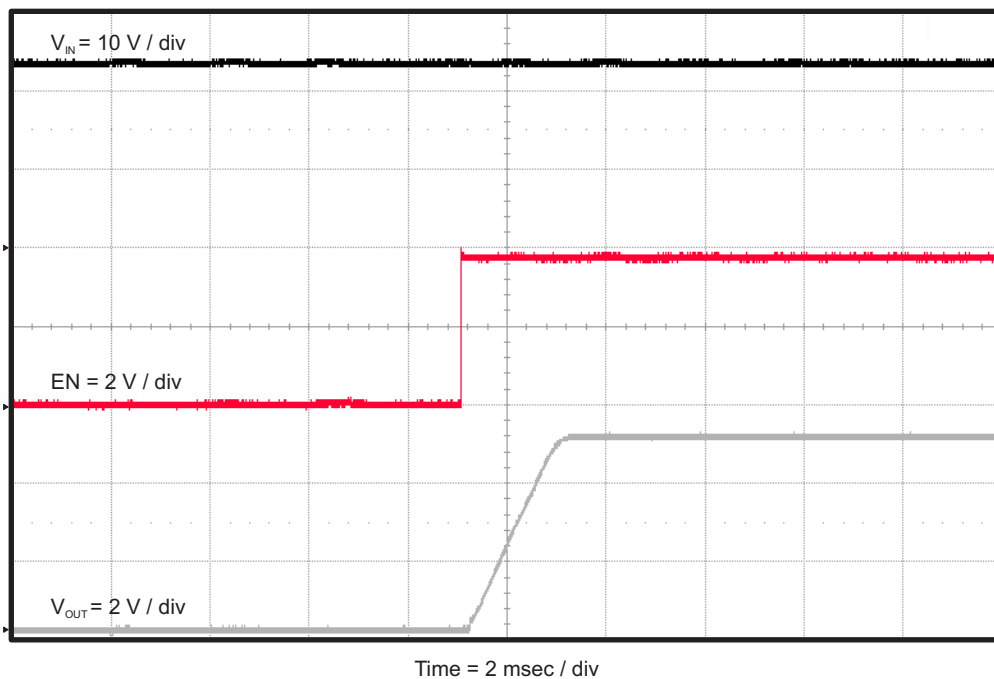

Figure 2-12. TPS54335AEVM-010 Start-up Relative to Enable

2.10 Powering Down

Figure 2-13 and Figure 2-14 show the start-up waveforms for the TPS54335AEVM-010. In Figure 2-13, the output voltage ramps down as soon as the input voltage falls below the UVLO stop threshold as set by the R1 and R2 resistor divider network. In Figure 2-14, the output is inhibited by using a jumper at JP1 to tie EN to GND. The input voltage for these plots is 24 V and the load is 5 Ω .

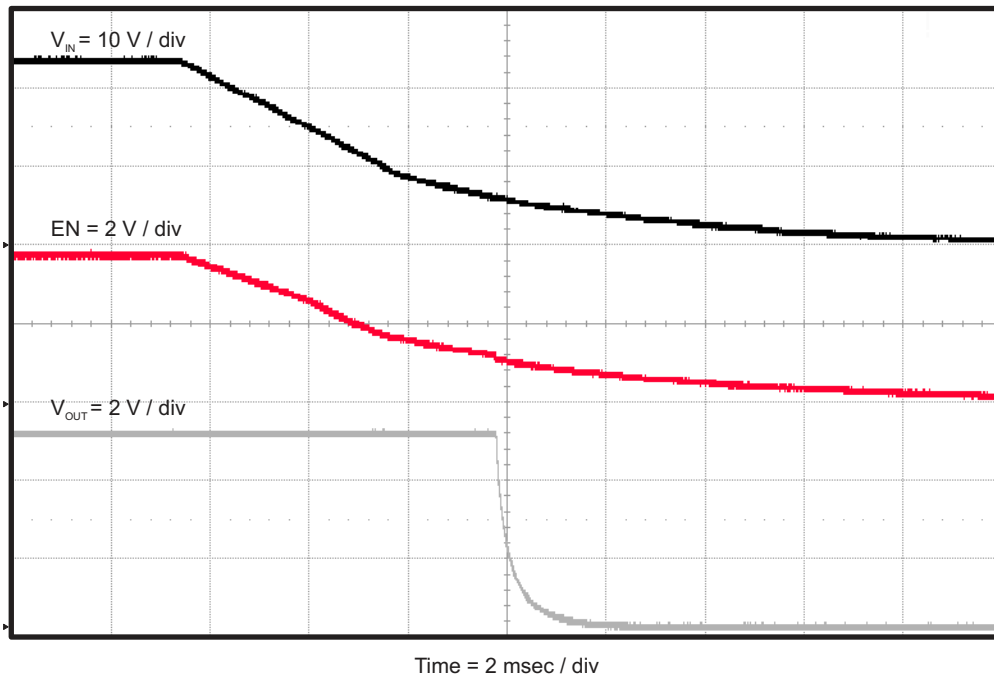

Figure 2-13. TPS54335AEVM-010 Shut-down Relative to V_{IN}

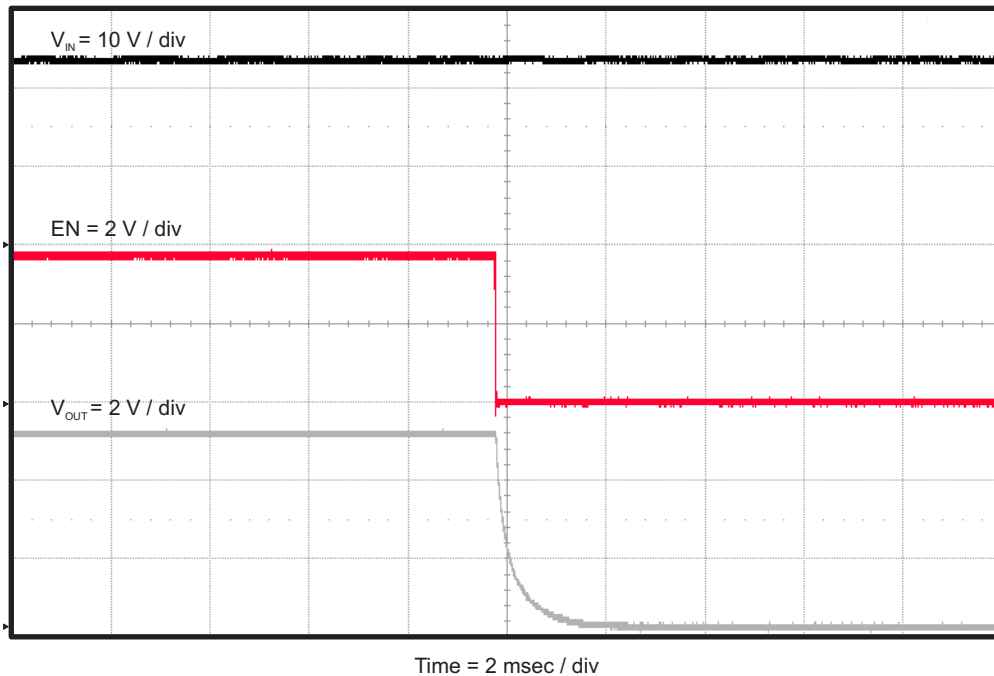

Figure 2-14. TPS54335AEVM-010 Shut-down Relative to EN

3 Board Layout

This section provides a description of the TPS54335AEVM-010, board layout, and layer illustrations.

3.1 Layout

Figure 3-1 through Figure 3-3 show the board layout for the TPS54335AEVM-010. The topside layer of the EVM is laid out in a manner typical of a user application. The top and bottom layers are 2-oz. copper.

The top layer contains the main power traces for V_{IN} , V_{OUT} , and V_{PHASE} . Also on the top layer are connections for the remaining pins of the TPS54335A and a large area filled with ground. To facilitate the placement of the main input bypass capacitor as close to the V_{IN} and GND pins as possible, the trace for V_{PHASE} is routed to the bottom layer immediately at the pin 3 connection. It is routed back to the top layer at the L1 inductor and C4 BOOT capacitor. The bottom layer contains a ground plane plus a copper fill area for V_{PHASE} , an etch run to connect the upper resistor of the voltage set point divider to the regulation point at the J2 output connector, and a trace to connect the upper resistor of the UVLO set point divider network to V_{IN} . The top-side ground areas are connected to the bottom and internal ground planes with multiple vias placed around the board including four vias directly under the TPS54335A device to provide a thermal path from the top-side ground area to the bottom-side and internal ground planes.

The input decoupling capacitors (C2, and C1) and bootstrap capacitor (C4) are all located as close to the IC as possible. In addition, the voltage set-point resistor divider components are also kept close to the IC. The BSR010 PCB is set up to accommodate both the TPS54335A and TPS54336A. For TPS54335A, the RT resistor R3 is used, while for TPS54336A, C3 is used to set the adjustable slow-start time. For the TPS54335A, an additional input bulk capacitor may be required, depending on the EVM connection to the input supply.

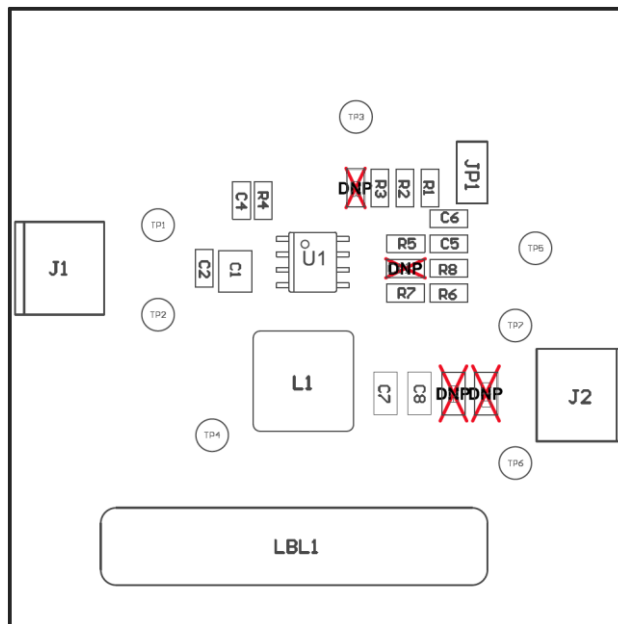

Figure 3-1. TPS54335AEVM-010 Top-Side Assembly

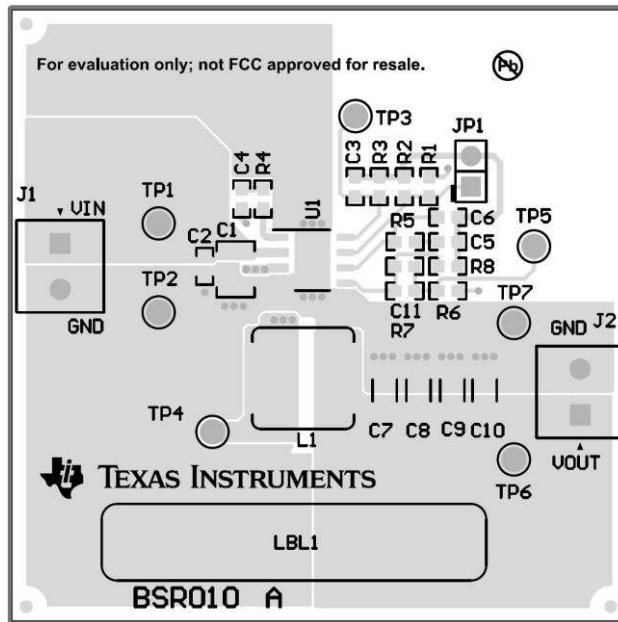

Figure 3-2. TPS54335AEVM-010 Top-Side Layout

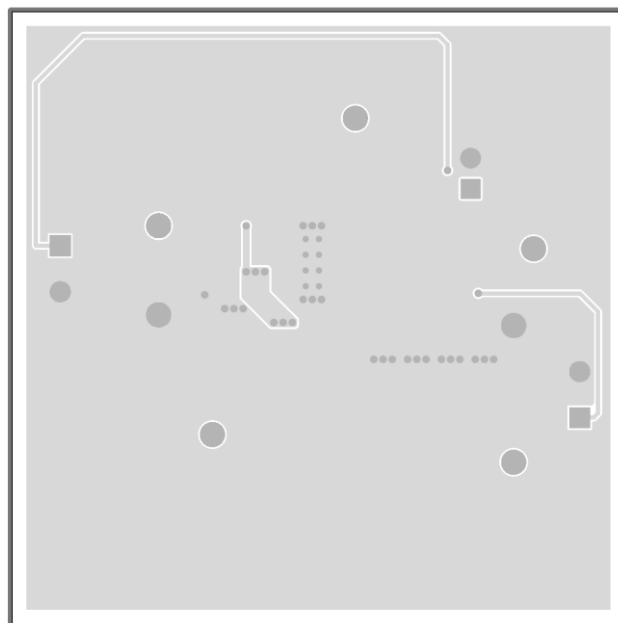

Figure 3-3. TPS54335AEVM-010 Bottom-Side Layout

4 Schematic and Bill of Materials

This section presents the TPS54335AEVM-010 schematic and bill of materials.

4.1 Schematic

Figure 4-1 is the schematic for the TPS54335AEVM-010.

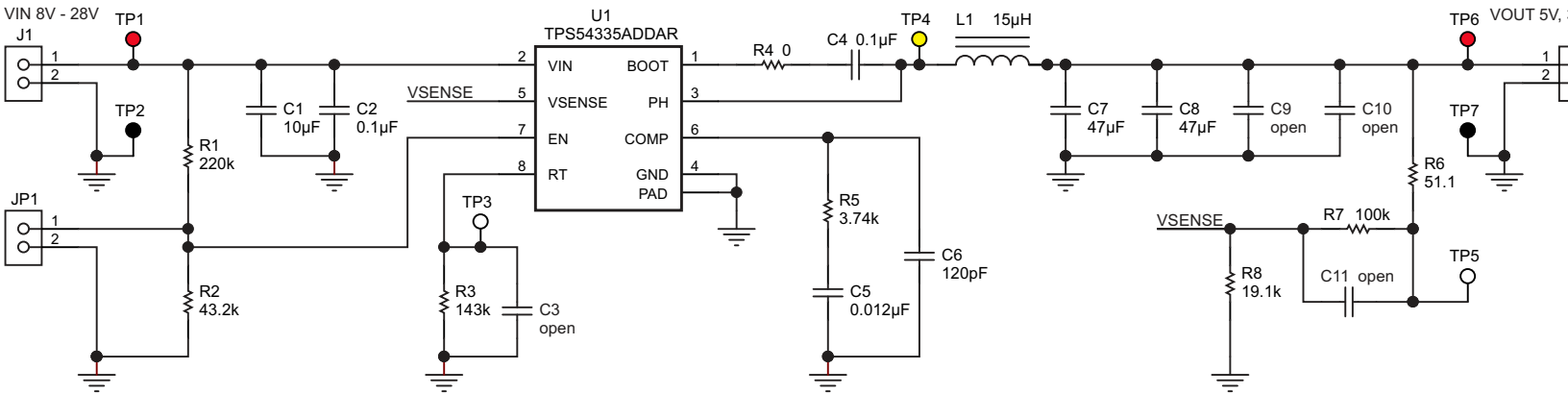

Copyright © 2017, Texas Instruments Incorporated

Figure 4-1. TPS54335AEVM-010 Schematic

4.2 Bill of Materials

Table 4-1 presents the bill of materials for the TPS54335AEVM-010.

Table 4-1. TPS54335AEVM-010 Bill of Materials

DESIGNATOR	QUANTITY	VALUE	DESCRIPTION	PACKAGE REFERENCE	PART NUMBER	MANUFACTURER
C1	1	10 μ F	CAP, CERM, 10 μ F, 35V, \pm 10%, X7R, 1210	1210	GRM32ER7YA106KA12L	MuRata
C2, C4	2	0.1 μ F	CAP, CERM, 0.1 μ F, 50V, \pm 10%, X7R, 0603	0603	GRM188R71H104KA93D	MuRata
C3	0		CAP, CERM, 0603	0603		
C5	1	0.012 μ F	CAP, CERM, 0.012 μ F, 50V, \pm 10%, X7R, 0603	0603	GRM188R71H123KA01D	MuRata
C6	1	120 pF	CAP, CERM, 120 pF, 50 V, \pm 5%, C0G/NP0, 0603	0603	GRM1885C1H121JA01D	MuRata
C7, C8	2	47 μ F	CAP, CERM, 47 μ F, 10V, \pm 10%, X5R, 1206	1206	GRM31CR61A476KE15L	MuRata
C9, C10	0		CAP, CERM, 1206	1206		
C11	0		CAP, CERM, 0603	603		
J1, J2	2		Conn Term Block, 2POS, 3.81 mm, TH	2 \times 1, 3.81 mm	1727010	Phoenix Contact
JP1	1		Header, TH, 100mil, 2 \times 1, Gold plated, 230 mil above insulator	2 \times 1, 100 mil	TSW-102-07-G-S	Samtec, Inc.
L1	1	15 μ H	Inductor, Shielded, Composite, 15 μ H, 3.6A, 0.04 Ω , SMD	322 \times 158 \times 322 mil	IHLP3232DZER150M5A	Vishay-Dale
R1	1	220 k	RES, 220 k Ω , 1%, 0.1W, 0603	0603	RC0603FR-07220KL	Yageo America
R2	1	43.2 k	RES, 43.2 k Ω , 1%, 0.1W, 0603	0603	CRCW060343K2FKEA	Vishay-Dale
R3	1	143 k	RES, 143 k Ω , 1%, 0.1W, 0603	0603	CRCW0603143KFKFA	Vishay-Dale
R4	1	0	RES, 0 Ω , 5%, 0.1 W, 0603	0603	CRCW06030000Z0EA	Vishay-Dale
R5	1	3.74 k	RES, 3.74k Ω , 1%, 0.1 W, 0603	0603	CRCW06033K74FKFA	Vishay-Dale
R6	1	51.1	RES, 51.1 Ω , 1%, 0.1 W, 0603	0603	CRCW060351R1FKFA	Vishay-Dale
R7	1	100 k	RES, 100 k Ω , 1%, 0.1 W, 0603	0603	CRCW0603100KFKFA	Vishay-Dale
R8	1	19.1 k	RES, 19.1 k Ω , 1%, 0.1 W, 0603	0603	CRCW060319K1FKFA	Vishay-Dale
SH-JP1	1		Shunt, 100mil, Gold plated, Black		382811-6	AMP
TP1, TP6	2	Red	Test Point, TH, Miniature, Red	TH, Miniature	5000	Keystone
TP2, TP7	2	Black	Test Point, TH, Miniature, Black	TH, Miniature	5001	Keystone
TP3, TP5	2	White	Test Point, TH, Miniature, White	TH, Miniature	5002	Keystone
TP4	1	Yellow	Test Point, TH, Miniature, Yellow	TH, Miniature	5004	Keystone
U1	1		4.5-V TO 28-V INPUT, 3-A OUTPUT, SYNCHRONOUS STEP DOWN SWIFT CONVERTER, DDA0008E	DDA0008E	TPS54335ADDAR	Texas Instruments
PCB	1		Printed Circuit Board		BSR010	Any

5 Revision History

NOTE: Page numbers for previous revisions may differ from page numbers in the current version.

Changes from Revision * (July 2017) to Revision A (October 2021)	Page
• Updated the numbering format for tables, figures, and cross-references throughout the document.	3
• Updated user's guide title.....	3

IMPORTANT NOTICE AND DISCLAIMER

TI PROVIDES TECHNICAL AND RELIABILITY DATA (INCLUDING DATA SHEETS), DESIGN RESOURCES (INCLUDING REFERENCE DESIGNS), APPLICATION OR OTHER DESIGN ADVICE, WEB TOOLS, SAFETY INFORMATION, AND OTHER RESOURCES "AS IS" AND WITH ALL FAULTS, AND DISCLAIMS ALL WARRANTIES, EXPRESS AND IMPLIED, INCLUDING WITHOUT LIMITATION ANY IMPLIED WARRANTIES OF MERCHANTABILITY, FITNESS FOR A PARTICULAR PURPOSE OR NON-INFRINGEMENT OF THIRD PARTY INTELLECTUAL PROPERTY RIGHTS.

These resources are intended for skilled developers designing with TI products. You are solely responsible for (1) selecting the appropriate TI products for your application, (2) designing, validating and testing your application, and (3) ensuring your application meets applicable standards, and any other safety, security, regulatory or other requirements.

These resources are subject to change without notice. TI grants you permission to use these resources only for development of an application that uses the TI products described in the resource. Other reproduction and display of these resources is prohibited. No license is granted to any other TI intellectual property right or to any third party intellectual property right. TI disclaims responsibility for, and you will fully indemnify TI and its representatives against, any claims, damages, costs, losses, and liabilities arising out of your use of these resources.

TI's products are provided subject to [TI's Terms of Sale](#) or other applicable terms available either on ti.com or provided in conjunction with such TI products. TI's provision of these resources does not expand or otherwise alter TI's applicable warranties or warranty disclaimers for TI products.

TI objects to and rejects any additional or different terms you may have proposed.

Mailing Address: Texas Instruments, Post Office Box 655303, Dallas, Texas 75265
Copyright © 2022, Texas Instruments Incorporated