

DATA SHEET

**ELECTROSTATIC DISCHARGE
PROTECTION DEVICES**

INDUSTRIAL / CONSUMER

UAT56A05L05

RoHS compliant & Halogen free



Product specification—July 04, 2023 V.2

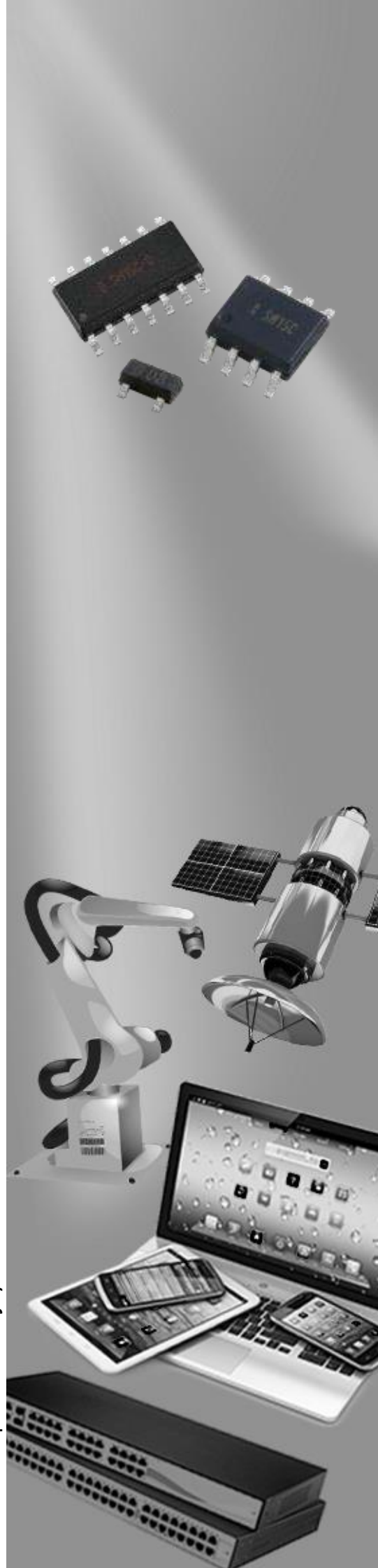

Electrostatic Discharged Protection Devices (ESD) Data Sheet

Description

The device is surge rated diode arrays designed to protect high speed data interfaces. It has been specifically designed to protect sensitive components which is connected to data and transmission lines from overvoltage caused by electrostatic discharge (ESD), electrical fast transients (EFT), and lightning.

The unique design of the device incorporates one surge rated, and four data lines. Low capacitance steering diodes and a TVS diode in a single package. The low capacitance array configuration allows the user to protect four high speed data or transmission lines.



Contact : ±8kV
Air : ±15kV



Features

- IEC61000-4-2 ESD 15KV Air, 8KV contact compliance
- SOT-563 surface mount package
- Protects four high-speed data lines and one power line
- Array of surge rated, low capacitance diodes
- Working voltage: 5V
- Low leakage current
- Low clamping voltage
- Solid-state silicon avalanche technology
- Lead Free/RoHS compliant
- Solder reflow temperature: Pure Tin-Sn, 260~270°C
- Flammability rating UL 94V-0
- Meets MSL level 1, per J-STD-020
- Marking: B T55

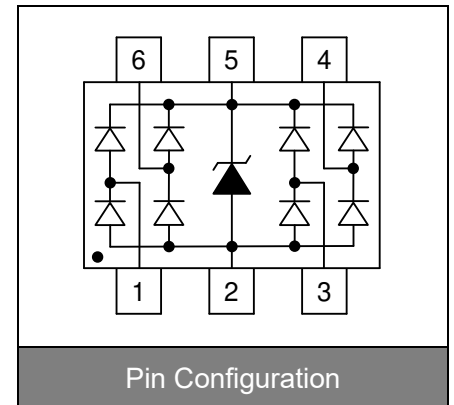

Applications

- USB power and data line protection
- 10/100/1000 Ethernet
- Video line protection
- I²C bus protection
- WAN/LAN equipment
- ISDN S/T interface
- Microcontroller input protection
- Portable electronics

Maximum Ratings

Rating	Symbol	Value	Unit
ESD voltage (Contact discharge)	V _{ESD}	±8	kV
ESD voltage (Air discharge)		±15	
Storage & operating temperature range	T _{STG} , T _J	-55~+150	°C

Electrical Characteristics (T_J=25°C)

Parameter	Symbol	Condition	Min.	Typ.	Max.	Unit
Reverse stand-off voltage	V _{RWM}				5	V
Reverse breakdown voltage	V _{BR}	I _{BR} =1mA	6			V
Reverse leakage current	I _R	V _R =5V Each I/O pin			1	μA
Clamping voltage (tp=8/20μs)	V _C	I _{PP} =1A			9.8	V
Clamping voltage (tp=8/20μs)	V _C	I _{PP} =2A			15	V
Peak pulse current (tp=8/20μs)	I _{PP}				3	A
Off state junction capacitance	C _J	0Vdc, f=1MHz Between I/O pins and GND		1		pF

Applications Information

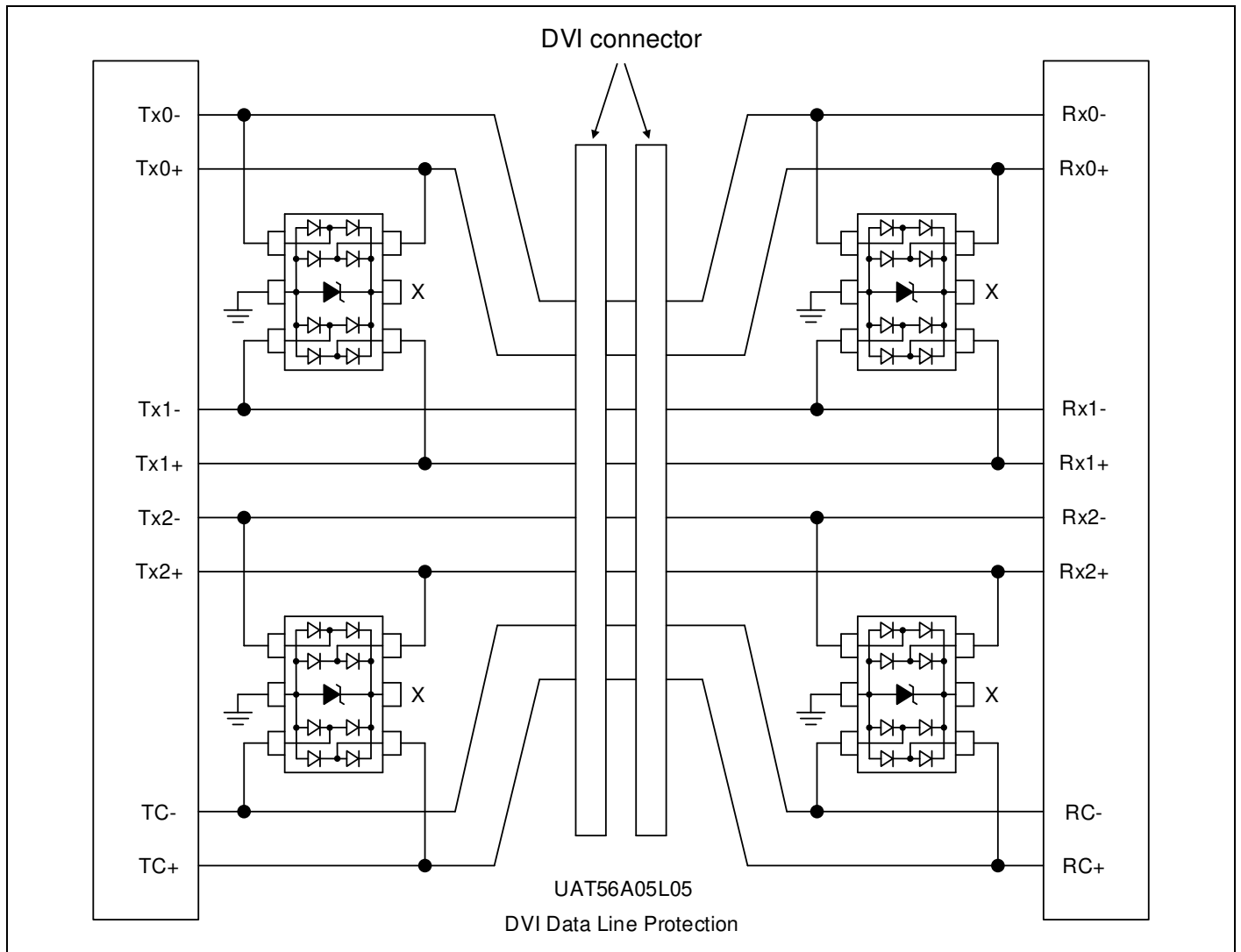

ESD Protection Standards

IEC61000-4-2

Interfaces of consumer electronic equipment are widely specified according to the International Electrotechnical Commission standard IEC61000-4-2. This standard is not targeted towards particular devices but towards general equipment, systems and subsystems that may be involved in electrostatic discharge. consists of a 150pF capacitor and a 330Ω series resistor representing the counterpart to the Device Under Test (DUT).

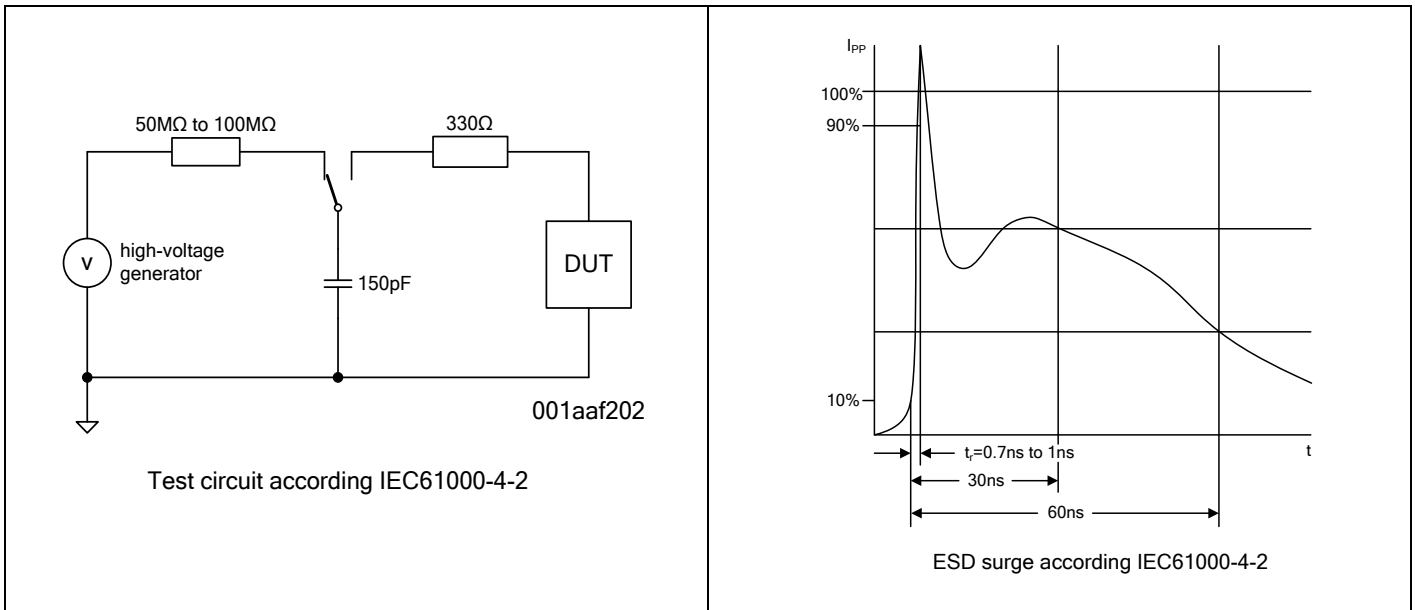

Human Body Model (HBM, MIL-883E method 3015.7)

The HBM standard simulates an ESD surge generated by human contact to electronic components.

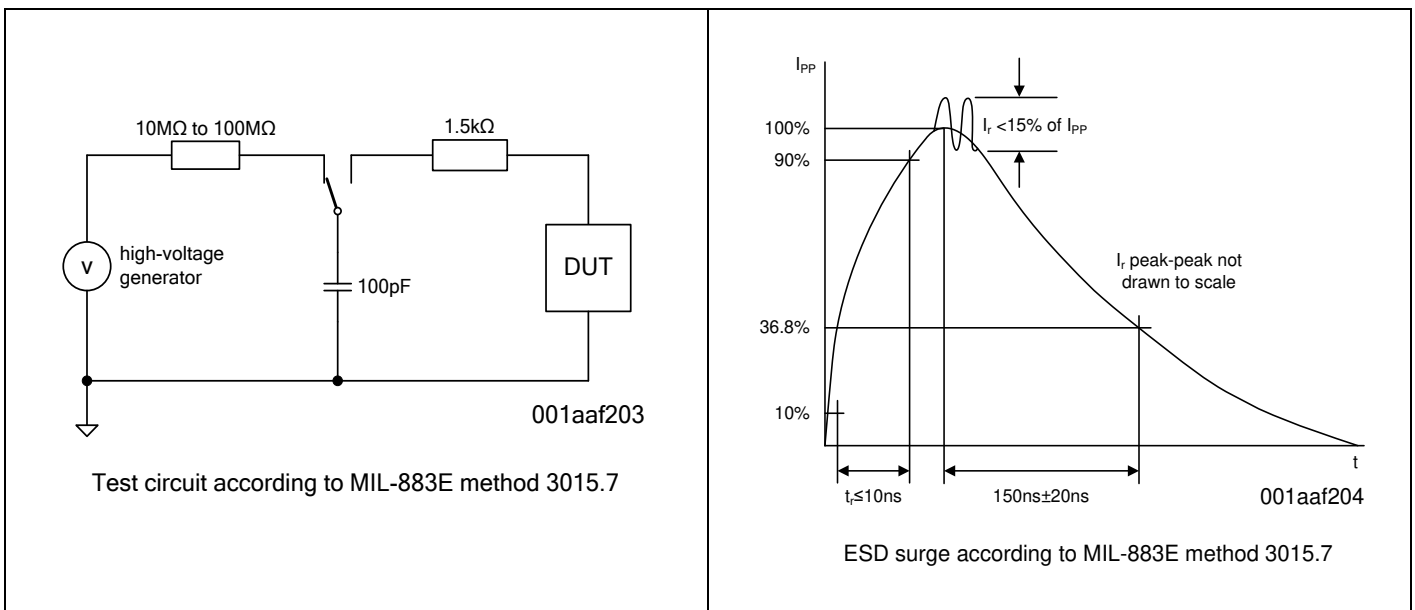

Recommended Soldering Conditions

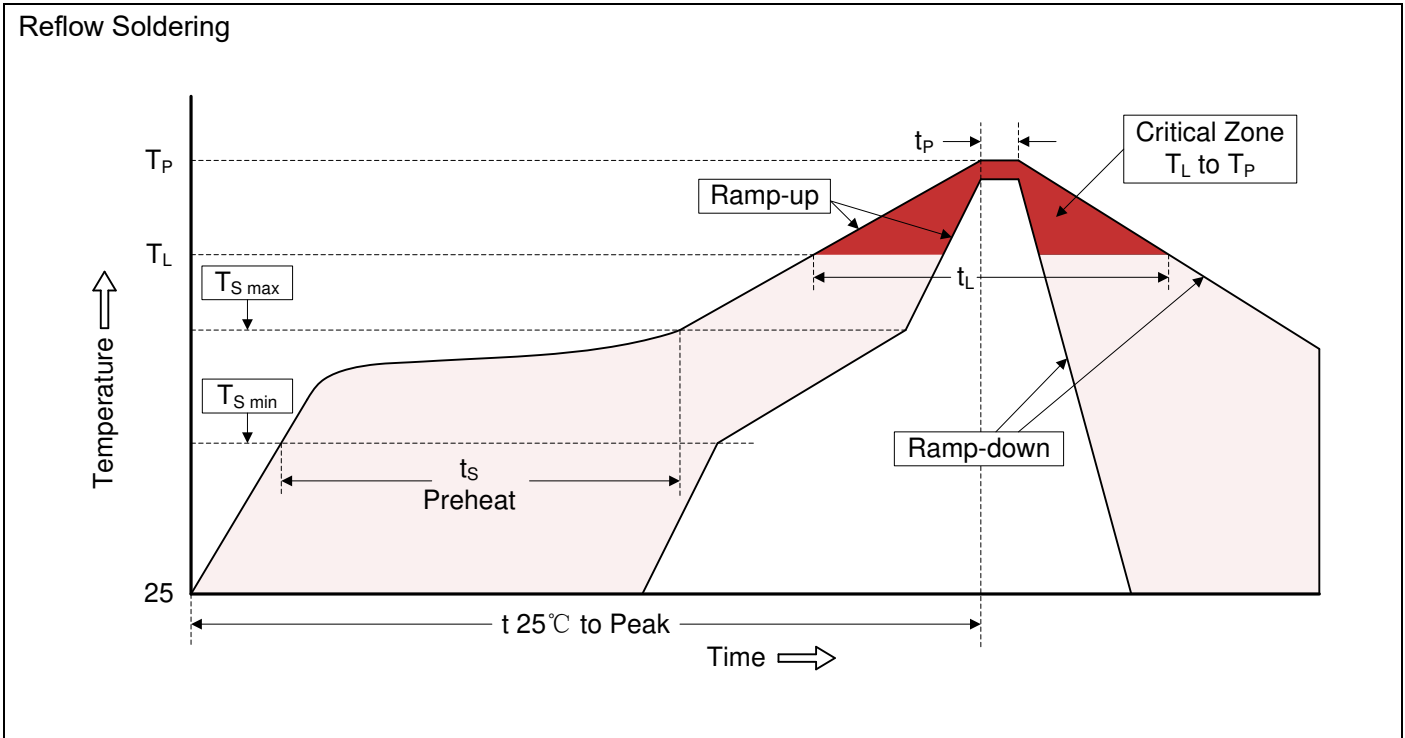

Recommended Conditions

Profile Feature	Pb-Free Assembly
Average ramp-up rate (T_L to T_P)	3°C/second max.
Preheat -Temperature Min ($T_{S\ min}$) -Temperature Max ($T_{S\ max}$) -Time (min to max) (t_s)	150°C 200°C 60-180 seconds
$T_{S\ max}$ to T_L -Ramp-up Rate	3°C/second max.
Time maintained above: -Temperature (T_L) -Time (t_L)	217°C 60-150 seconds
Peak Temperature (T_P)	260°C
Time within 5°C of actual Peak Temperature (t_P)	20-40 seconds
Ramp-down Rate	6°C/second max.
Time 25°C to Peak Temperature	8 minutes max.

Dimensions (SOT-563)

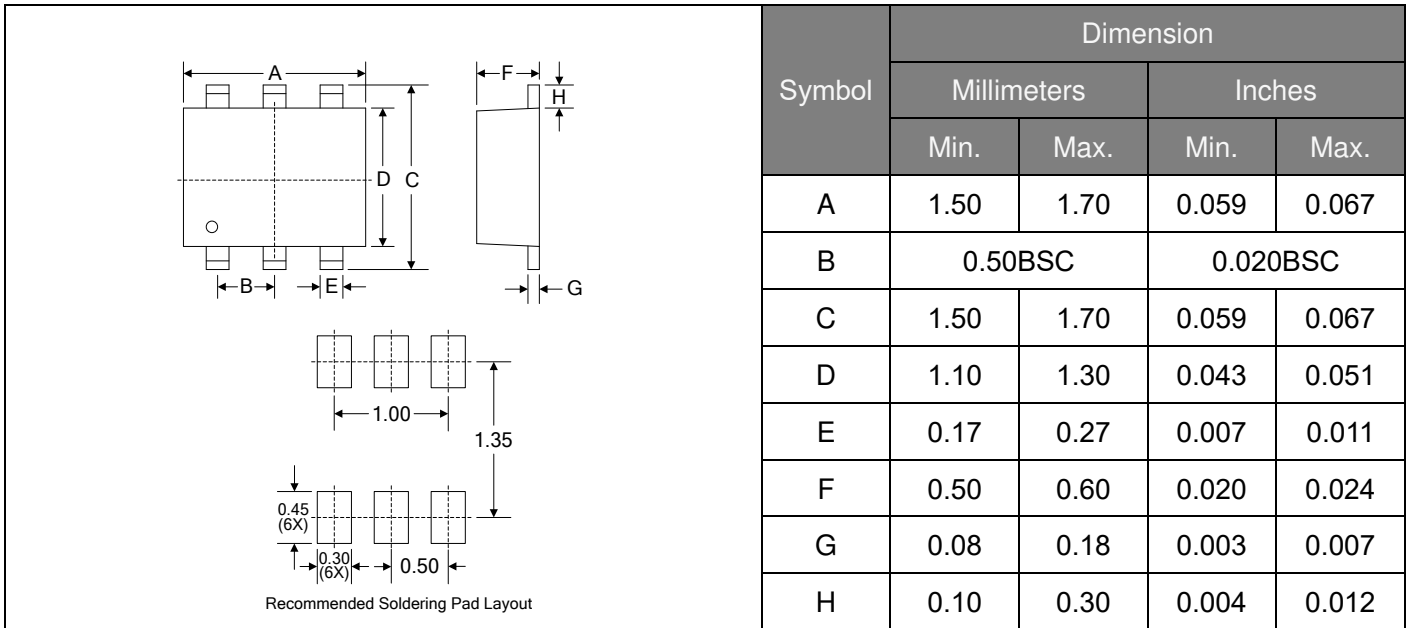

Packaging

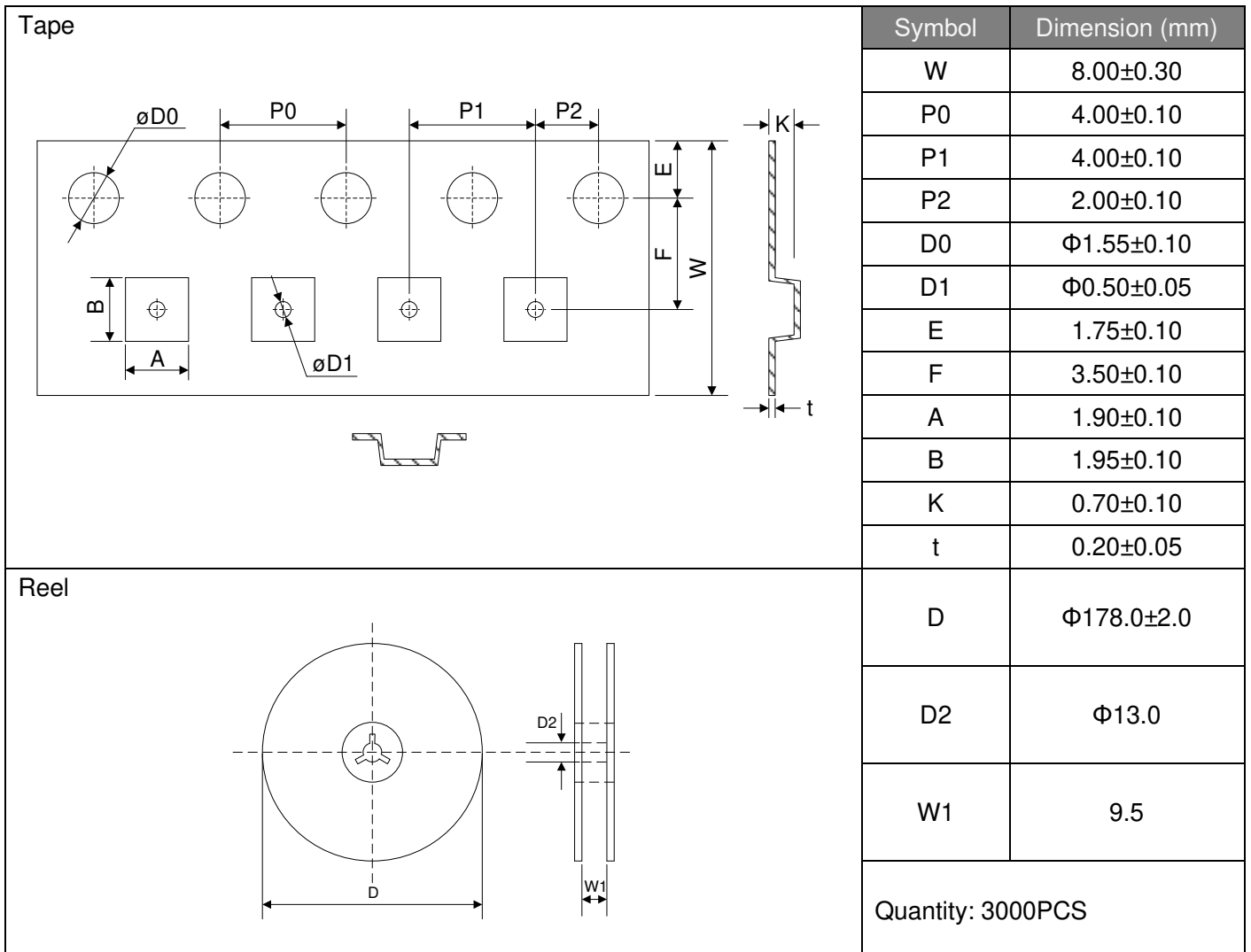

LEGAL DISCLAIMER

YAGEO, its distributors and agents (collectively, "YAGEO"), hereby disclaims any and all liabilities for any errors, inaccuracies or incompleteness contained in any product related information, including but not limited to product specifications, datasheets, pictures and/or graphics. YAGEO may make changes, modifications and/or improvements to product related information at any time and without notice.

YAGEO makes no representation, warranty, and/or guarantee about the fitness of its products for any particular purpose or the continuing production of any of its products. To the maximum extent permitted by law, YAGEO disclaims (i) any and all liability arising out of the application or use of any YAGEO product, (ii) any and all liability, including without limitation special, consequential or incidental damages, and (iii) any and all implied warranties, including warranties of fitness for a particular purpose, non-infringement and merchantability.

YAGEO products are designed for general purpose applications under normal operation and usage conditions. Please contact YAGEO for the applications listed below which require especially high reliability for the prevention of defects which might directly cause damage to the third party's life, body or property: Aerospace equipment (artificial satellite, rocket, etc.), Atomic energy-related equipment, Aviation equipment, Disaster prevention equipment, crime prevention equipment, Electric heating apparatus, burning equipment, Highly public information network equipment, data-processing equipment, Medical devices, Military equipment, Power generation control equipment, Safety equipment, Traffic signal equipment, Transportation equipment and Undersea equipment, or for any other application or use in which the failure of YAGEO products could result in personal injury or death, or serious property damage. Particularly **YAGEO Corporation and its affiliates do not recommend the use of commercial or automotive grade products for high reliability applications or manned space flight.**

Information provided here is intended to indicate product specifications only. YAGEO reserves all the rights for revising this content without further notification, as long as products are unchanged. Any product change will be announced by PCN.