



DOCUMENT NUMBER AND REVISION
VL-FS-VIM_503_V01 REV. A
(VIM_503_V01)

DOCUMENT TITLE:
SPECIFICATION
OF
LCD TYPE

CUSTOMER	STANDARD
MODEL NUMBER	VIM_503_V01
CUSTOMER APPROVAL	
DATE	

DEPARTMENT	NAME	SIGNATURE	DATE
PREPARED BY	J.XIAO		2013.05.21
CHECKED BY	X.Z.LUO		2013.05.21
APPROVED BY	KELVIN.LAI		2013.05.21
QUALITY BY	MICHAEL.HUI		2013.05.21

DISTRIBUTION LIST: MARKETING



DOCUMENT REVISION HISTORY 1:

DOCUMENT REVISION FROM TO	DATE	DESCRIPTION	CHANGED BY	CHECKED BY
A	2013.05.21	First Release (Based on a.)LCD PID: VIM_503_V01, cover page Rev.A, 2011.11.29 with counter drawing VIM-503-1(REV.2). b.) VL-QUA-012A, REV. T, 2008.12.16. According to VL-QUA-012A, for positive mode, LCD size is small because Unit Per Laminate=36 which is more than 6 pcs/Laminate.)	J.XIAO	X.Z.LUO, MICHAEL.HUI

CONTENTS

1.	LCD SPECIFICATIONS	4
2.	LCD DRAWING	6
3.	ENVIRONMENTAL CONDITION	14
4.	ELECTRO-OPTICAL CHARACTERISTICS	14
4.1	ISO CONTRAST PLOT AT ROOM TEMPERATURE	15
4.2	OPTICAL CHARACTERISTICS DEFINITION	15
5.	LCD COSMETIC CONDITIONS	17
6.	PACKAGE DRAWING	30
7.	PACKING REMOVAL AND HANDLING REQUIREMENT	31



1. LCD Specifications

- RoHS Compliance. LCD display.
- Weight : 9g



VARITRONIX LIMITED

TELEX: 36643 VTRAX HX

TELEFAX: (852) 23439704

COVER PAGE REVISION : A		PAGE : 1 / 2
P.I.D.	VIM_503_V01	
COUNTER DRAWING REVISION NO.	VIM-503-1 (REV.2)	
FEASIBILITY STUDY NO.	-----	
CUSTOMER NAME / REF. NO.	STANDARD / VIM_503-DP-HV-RC	
CUSTOMER LCD DRAWING REF. NO.	-----	
MODE/COLOR/TYPE	POSITIVE / -- / TN	
VIEWING DIRECTION	6:00 O'CLOCK	
CONNECTOR TYPE	SHOULDER PINS (L = 6.35+/-0.5mm)	
LEAD-FREE REQUIREMENT FOR PIN (Y/N)	YES	
DRIVING IC	-----	
DRIVING SCHEME	1/3 DUTY 1/3 BIAS	
DRIV. VOLTAGE (VLCD)	~4.2 VOLT(p-p) +20 °C	
OPERATING TEMP. °C	-10	+60
STORAGE TEMP. °C	-20	+60
POLARIZER--FRONT	STD. TRANSMISSIVE	
POLARIZER--BACK	STD. REFLECTIVE	
BACKLIGHT	COLOR : -----	
	WAVELENGTH / SPECTRUM : -----	
	INTENSITY / LUMINANCE : -----	
BEZEL / HOUSING (ASSUME METAL IF NO INFO. PROVIDE)	NO INFORMATION	
GOVERNMENT SAFETY AND ENVIRONMENTAL REGULATION	-----	
SAFETY REQUIREMENT	-----	
THE IMPACT OF DESIGN CHANGE	-----	
VX DISPLAY (PID) TO PUT IN THE SAME DEVICE	-----	
PERFORMANCE REFERENCE TO VX DISPLAY (PID)	-----	
INK-JET PRINTING DIAGRAM DOC. NO.	-----	
INK PRINTING LOCATION DIAGRAM DOC. NO.	-----	
PULLING TAPE / ROUND LABEL DIAGRAM DOC. NO.	-----	
POLARIZER DIAGRAM DOC. NO.	PL-VIM-503-02	
PIN DIAGRAM DOC. NO.	DP-VIM-503-02	
RTV COATING LOCATION DIAGRAM DOC. NO.	-----	
GLASS GRADE	G1	
BEVEL EDGE (Yes/No)	YES	
CORNER CUT / DRILL HOLE DIAGRAM DOC.NO	NO	
ESD TEST REQUIREMENT (DOC. NO. IF ANY)	NO	
REMARKS:		
PREPARED BY :	MAKO <i>Mako</i>	DATE : 29-Nov-11
CHECKED BY :	ERIC <i>[Signature]</i>	DATE : 29-Nov-11
CUSTOMER APPROVAL:		
<small>a) TO HELP ACCELERATE THE PROTOTYPE LEAD TIME, PLEASE RETURN THIS SIGNED SPEC APPROVAL OR COMMENTS WITHIN 3 DAYS. b) VIA E-MAIL FOR FURTHER DOCUMENTAL COMMUNICATION AND WITHOUT TWO WAYS DOCUMENTAL COMMUNICATION. PLEASE USE 'PID' AS A REFERENCE IN FUTURE COMMUNICATION. c) LAYOUT INSPECTION : IF NO CUSTOMER REQUEST , ALL LAYOUT INSPECTION SHOULD BE PERFORMED ON ANNUAL BASIS.</small>		

REV.	ITEM	AMENDMENT	DATE
0	---	REISSUE DRAWING	2011-11-16
2	---	REISSUE DRAWING	2011-11-29
---	---	---	---
---	---	---	---
---	---	---	---
---	---	---	---
---	---	---	---
---	---	---	---
---	---	---	---

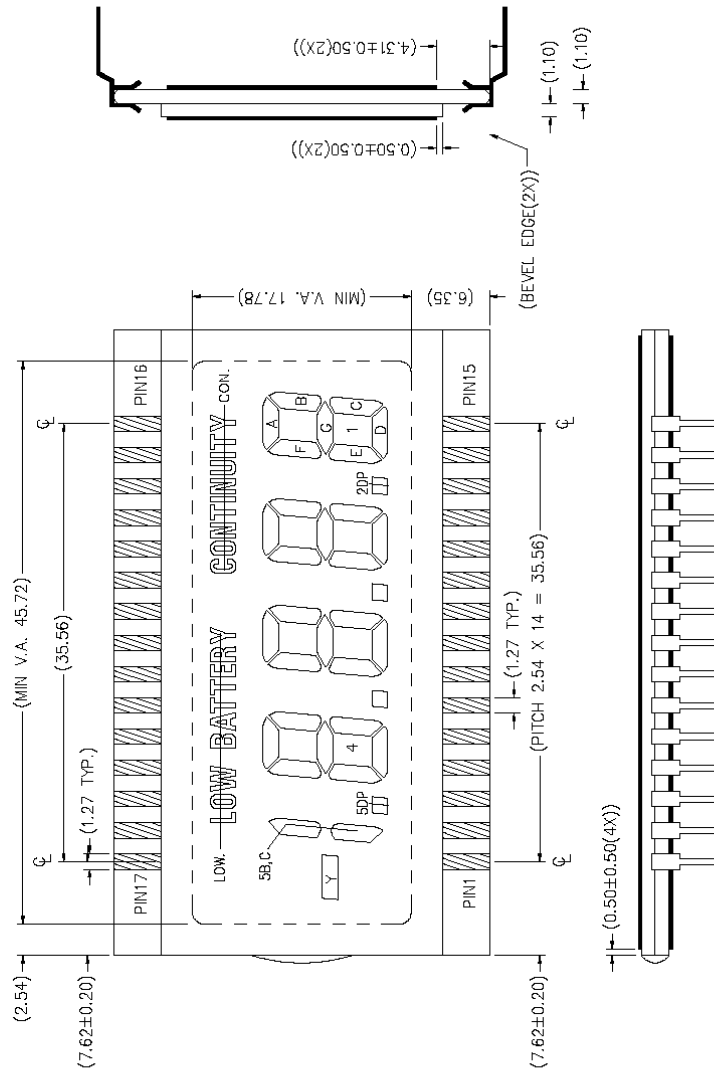

DRAWING NO. : VIM-503-12		REV	
NAME	SIGN	DATE	
DRAWN BY: MAKO	<i>Mako</i>	2011-11-29	
CHECKED BY: ERIC		2011-11-29	
DO NOT SCALE DRAWING			
TOL : ±0.2 IF NOT SPECIFY			
DIMENSION : mm			
SHEETS : 2 OF 8			

- NOTES:
- ◇ : SPECIAL CHARACTERISTIC
 - + : SAFETY CHARACTERISTIC
 - () : REFERENCE DIMENSION

Figure 2: LCD Drawing 2

REV.	ITEM	AMENDMENT	DATE
0	---	REISSUE DRAWING	2011-11-16
2	---	REISSUE DRAWING	2011-11-29
---	---	---	---
---	---	---	---
---	---	---	---
---	---	---	---
---	---	---	---
---	---	---	---
---	---	---	---

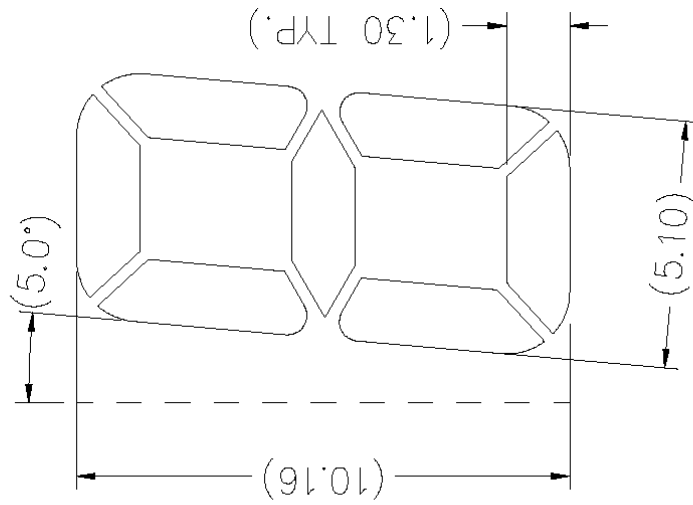

DIGIT 1 - 5

- NOTES:**
1. ◇ : SPECIAL CHARACTERISTIC
 2. + : SAFETY CHARACTERISTIC
 3. () : REFERENCE DIMENSION





DWGNO : VIM-503-1		REV 2	
NAME	SIGN	DATE	
DRAWN BY: MAKO	<i>MAKO</i>	2011-11-29	
CHECKED BY: ERIC	<i>ERIC</i>	2011-11-29	
DO NOT SCALE DRAWING			
TOL : ±0.2 IF NOT SPECIFY			
DIMENSION : mm			
SHEETS : 3 OF 8			
 3 rd ANGLE PROJECTION			 VARITRONIX LIMITED

Figure 3: LCD Drawing 3

REV.	ITEM	AMENDMENT	DATE
0	---	REISSUE DRAWING	2011-11-16
2	---	REISSUE DRAWING	2011-11-29
---	---	---	---
---	---	---	---
---	---	---	---
---	---	---	---
---	---	---	---
---	---	---	---
---	---	---	---
---	---	---	---

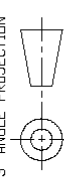
PIN	COM1	COM2	COM3
1	4F	4E	5DP
2	4A	4G	4D
3	4B	4C	5B,C
4	3F	3E	4DP
5	3A	3G	3D
6	3B	3C	Y
7	2F	2E	3DP
8	2A	2G	2D
9	2B	2C	LOW.
10	1F	1E	2DP
11	1A	1G	1D
12	1B	1C	CON.
13	COM1	---	---
14	---	COM2	---
15	---	---	COM3
16-30	NO CONNECTION		

DWG NO. : VIM-503-1 2 REV

NAME	SIGN	DATE
DRAWN BY: MAKO		2011-11-29
CHECKED BY: ERIC		2011-11-29

DO NOT SCALE DRAWING
 TOL : ±0.2 IF NOT SPECIFY
 DIMENSION : mm
 SHEETS : 4 OF 8

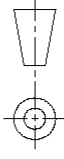
3rd ANGLE PROJECTION



VARITRONIX LIMITED

- NOTES:**
- ◇ : SPECIAL CHARACTERISTIC
 - + : SAFETY CHARACTERISTIC
 - () : REFERENCE DIMENSION

Figure 4: LCD Drawing 4

REV.	ITEM	AMENDMENT	DATE
0	---	REISSUE DRAWING	2011-11-16
2	---	REISSUE DRAWING	2011-11-29

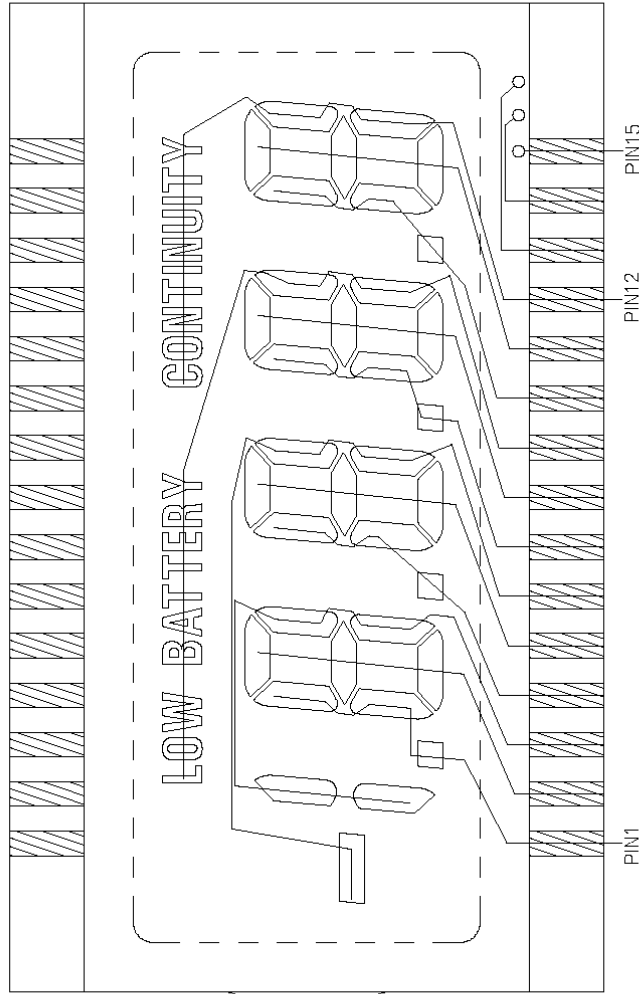

DWG NO: VIM-503-12 REV

NAME	SIGN	DATE
DRAWN BY: MAKO	<i>MAKO</i>	2011-11-29
CHECKED BY: ERLC	<i>ERLC</i>	2011-11-29

DO NOT SCALE DRAWING
 TOI : ED.2 IF NOT SPECIFY
 DIMENSION : mm
 SHEETS : 5 OF 8

3rd ANGLE PROJECTION

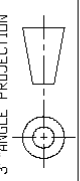

VARITRONIX LIMITED



- NOTES:**
- ◇ : SPECIAL CHARACTERISTIC
 - + : SAFETY CHARACTERISTIC
 - () : REFERENCE DIMENSION

Figure 5: LCD Drawing 5

REV.	ITEM	AMENDMENT	DATE
0	---	REISSUE DRAWING	2011-11-16
2	---	REISSUE DRAWING	2011-11-29
---	---	---	---
---	---	---	---
---	---	---	---
---	---	---	---
---	---	---	---
---	---	---	---
---	---	---	---
---	---	---	---

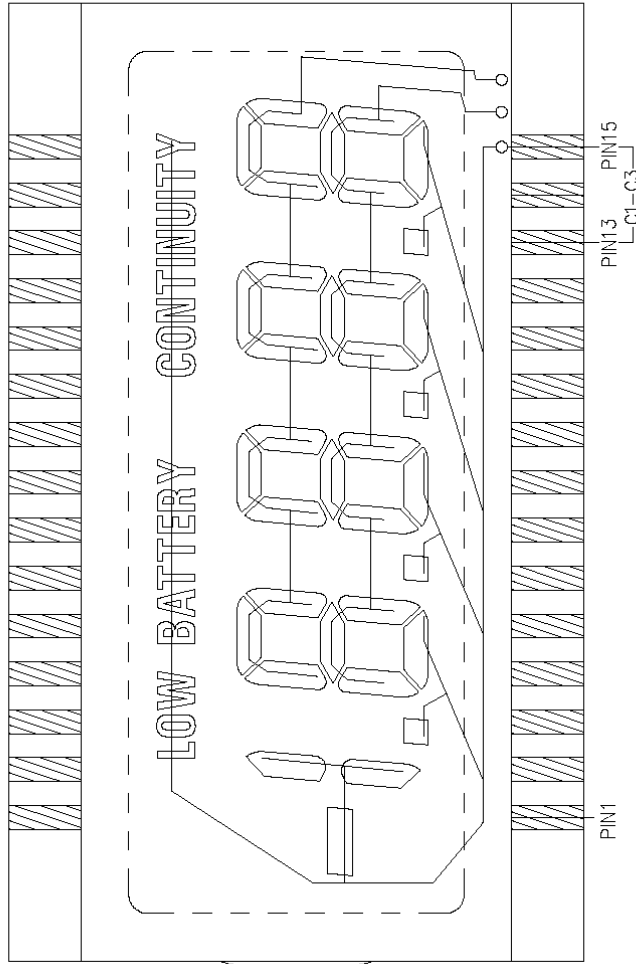

DWG NO : VIM-503-1 2 REV

NAME	SIGN	DATE
DRAWN BY: MAKO	<i>MAKO</i>	2011-11-29
CHECKED BY: ERLC	<i>ERLC</i>	2011-11-29

DO NOT SCALE DRAWING
 TOL : ±0.2 IF NOT SPECIFY
 DIMENSION : mm
 SHEETS : 6 OF 8

3rd ANGLE PROJECTION

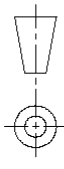



VARITRONIX LIMITED



- NOTES:**
- ◇ : SPECIAL CHARACTERISTIC
 - + : SAFETY CHARACTERISTIC
 - () : REFERENCE DIMENSION

Figure 6: LCD Drawing 6

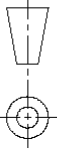
REV.	ITEM	AMENDMENT	DATE
0	---	REISSUE DRAWING	2011-11-16
2	---	REISSUE DRAWING	2011-11-29

DWG NO. : VIM-503-1		REV 2	
NAME	SIGN	DATE	
DRAWN BY: MAKO	<i>Mako</i>	2011-11-29	
CHECKED BY: ERIC		2011-11-29	
DO NOT SCALE DRAWING	3rd ANGLE PROJECTION		
TOL : ±0.2 IF NOT SPECIFY			
DIMENSION : mm	SHEETS : 7 OF 8		
 VARITRONIX LIMITED			

VARITRONIX LIMITED		DATE LAYER :	SCALE
DIL-PIN DETAILS LOCATION DIAGRAM		DP-10	Do not scale
DOC. NO. : DP-VIM-503-02		Drawn by : MEI	Date : 2011-11-29
ALL DIMENSIONS IN mm		Checked by : MAKO	Date : 2011-11-29
		Approved by : <i>[Signature]</i>	Date : 2011-11-29

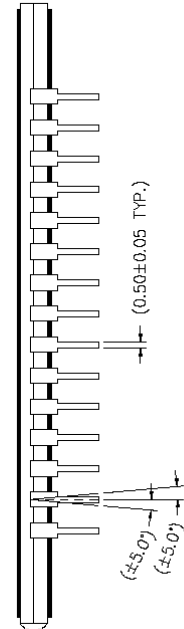
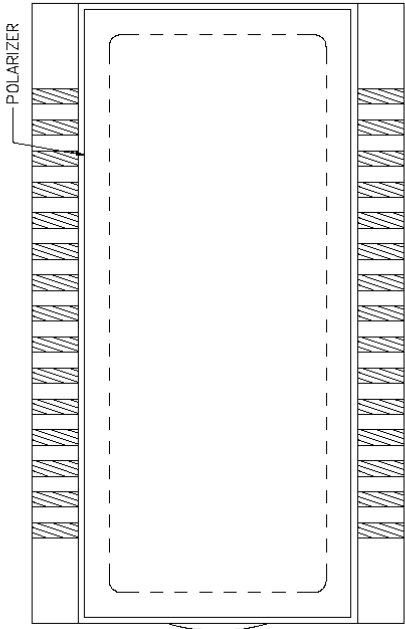
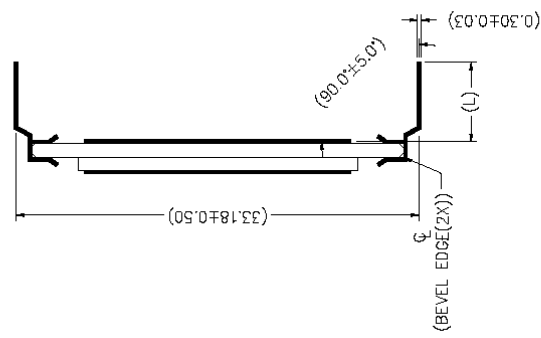

REMARKS: PIN LENGTH (L) REFER TO COVER PAGE

NOTES:

1. ◇ : SPECIAL CHARACTERISTIC
2. + : SAFETY CHARACTERISTIC
3. () : REFERENCE DIMENSION

Figure 7: LCD Drawing 7

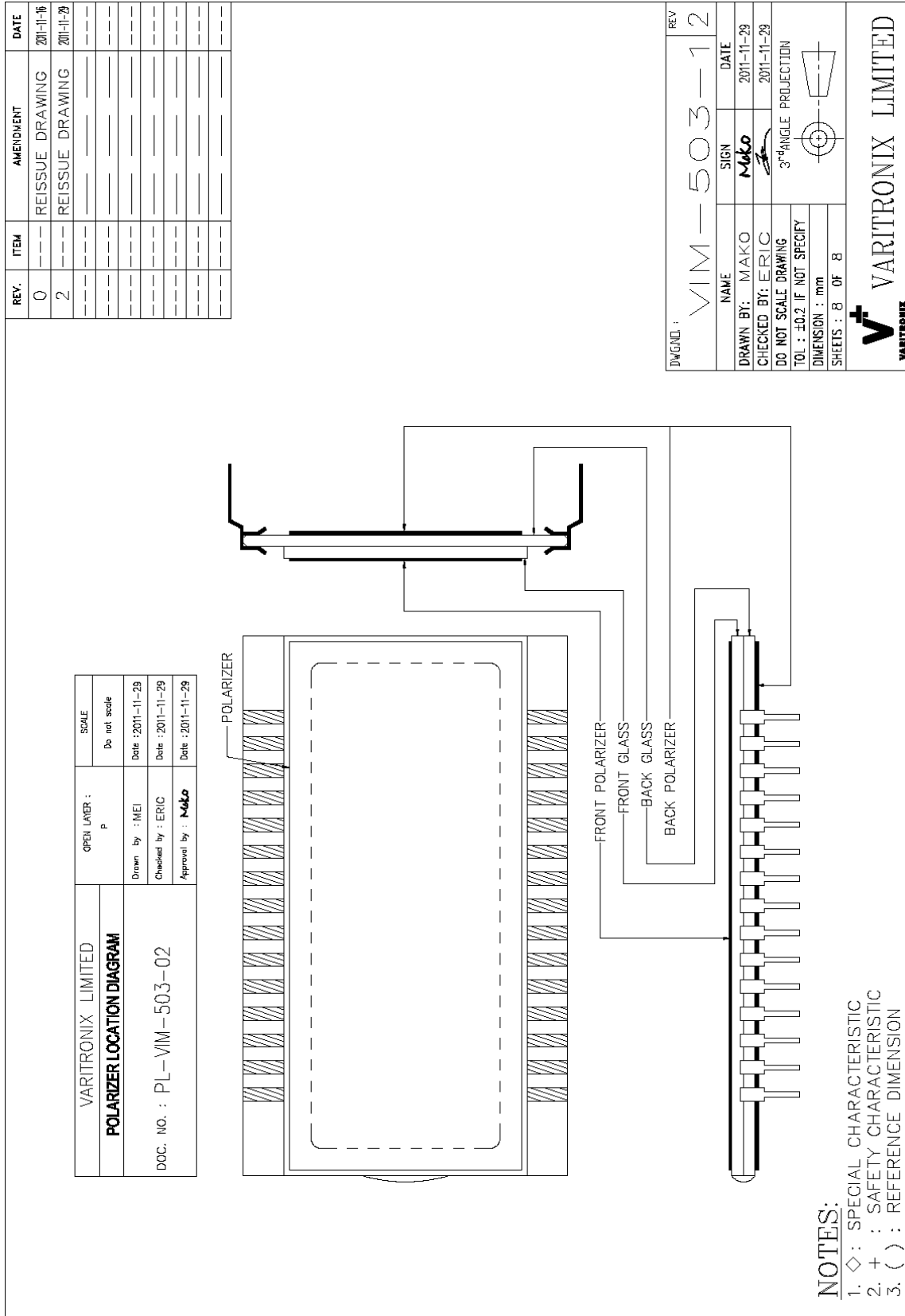

Figure 8: LCD Drawing 8

3. Environmental Condition

Table 1

Item	Operating temperature(Topr)		Storage temperature(Tstg)(Note 1)		Remark
	Min.	Max.	Min.	Max.	
Ambient temperature	-10°C	+60°C	-20°C	+60°C	Dry
Humidity (Note 1)	90% max. RH for Ta ≤ 40°C < 50% RH for 40°C < Ta ≤ Maximum operating temperature				No condensation
Vibration (IEC 68-2-6) cells must be mounted on a suitable connector	Frequency: 10 ~ 55 Hz Amplitude: 0.75 mm Duration: 20 cycles in each direction.				3 directions
Shock (IEC 68-2-27) Half-sine pulse shape	Pulse duration: 11 ms Peak acceleration: 981 m/s ² = 100g Number of shocks: 3 shocks in 3 mutually perpendicular axes.				3 directions

Note 1: Product cannot sustain in extreme storage conditions for a long time.

4. Electro-Optical Characteristics

Table 2

Item	Symbol	Temp.	Value			Unit	Condition
		°C	Min.	Typ.	Max.		
Driving voltage	Vop	+25	-	4.2	-	v	Vop= Optimum voltage
Response time	Ton	+25	-	60	100	ms	Vop= Optimum voltage φ=0° θ=0°
	Toff		-	45	80		
Optimum viewing area Cr ≥ 2	θ1(6 o'clock)	+25	40	50	-	deg	Vop= Optimum voltage φ=0° θ=0° (Remark 1)
	θ2(12 o'clock)		22	32	-		
	φ1(3 o'clock)		45	>50	-		
	φ2(9 o'clock)		45	>50	-		
Contrast ratio	Cr	+25	12	17	-	-	Vop = Optimum φ=0° θ=0°

Remark 1: Due to hardware limitation, the maximum measurable angle is 50° .

4.1 ISO Contrast Plot at room temperature

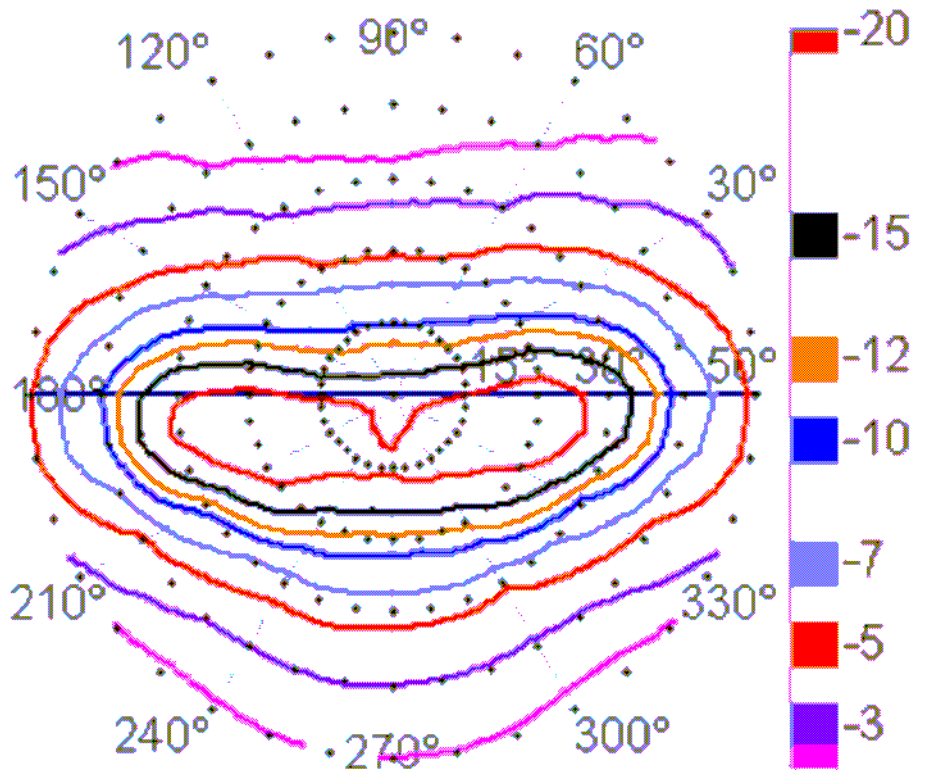

4.2 Optical Characteristics Definition

a.) Viewing Angle

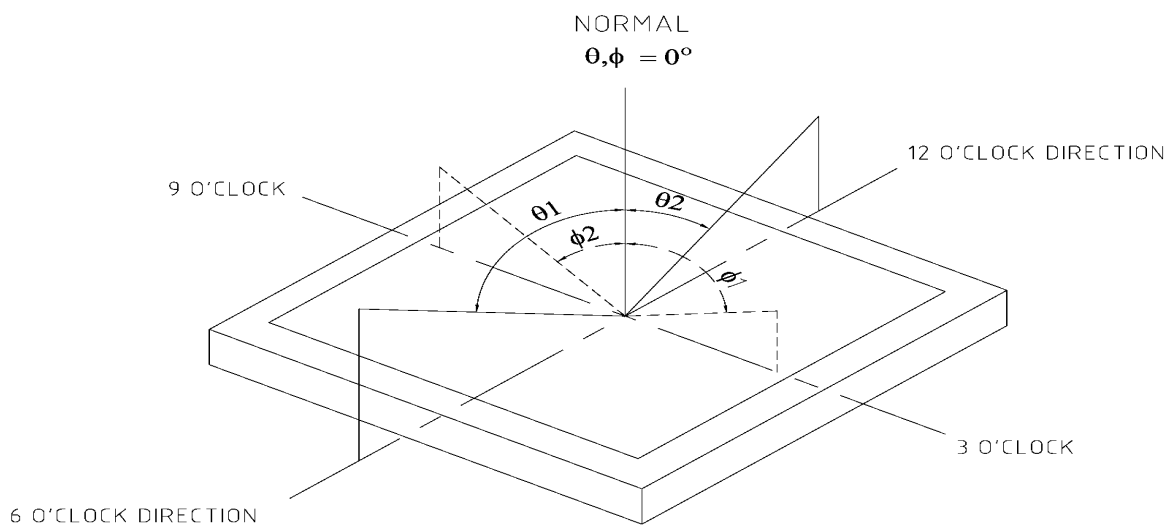

b.) Contrast Ratio

B1 = segments luminance in case of selected waveform

B2 = segments luminance in case of non-selected waveform

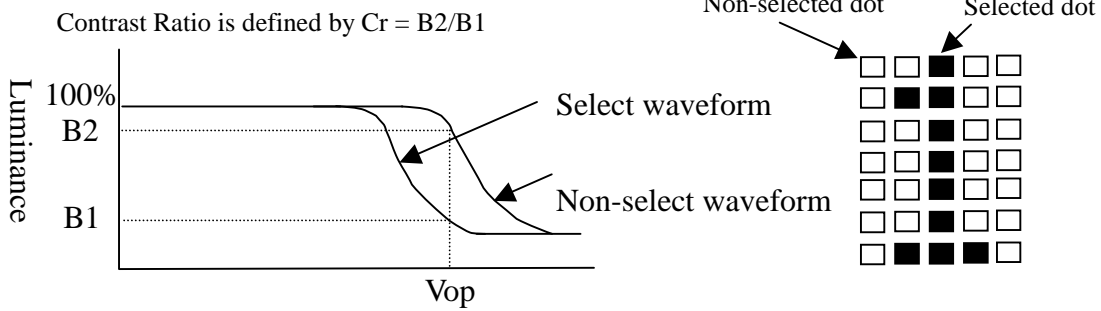

c.) Response Time

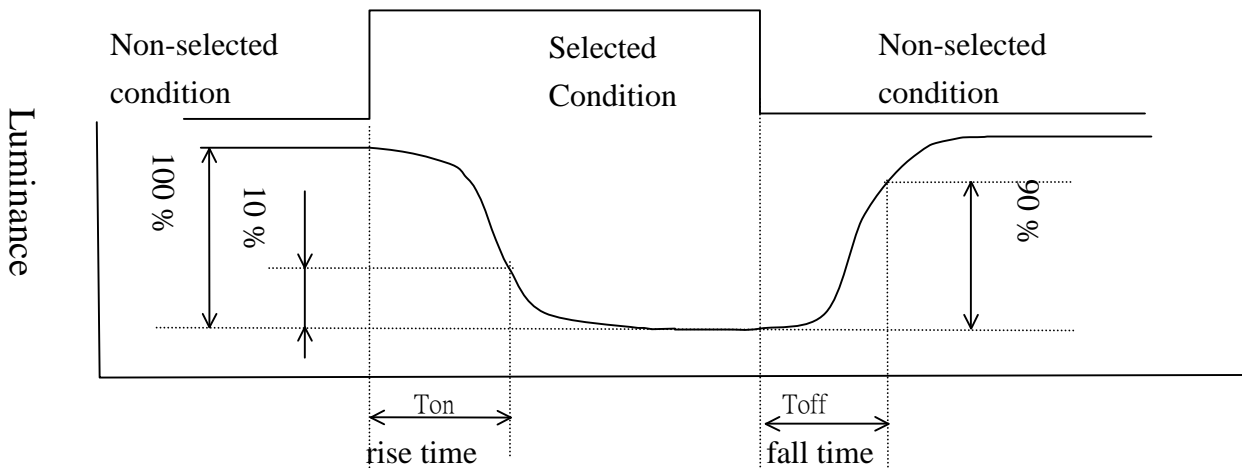

5. LCD Cosmetic Conditions

Refer to VL-QUA-012A.

Note:LCD size of the product is small size.

- 1.0 TITLE: final QA inspection for LCD products (G1);
- 2.0 PURPOSE:
to define the final QA inspection procedures and criteria for LCD product;
- 3.0 Scope:
This document applies to mass production of all G1 LCD after electrical test and before polarizer sticking process, LCD final inspection and ready for final QA sampling inspection, except of those with special requirements from customer;
- 4.0 DEFINITION:
- 4.1 ZONE A: EAA: Effective Active Area;
ZONE B: EVA/VA: Viewing Area;
ZONE C: Outside V.A;
- 4.2 Large Size (L), Middle Size(M), Small Size(S) are defined as below:

alignment	Mode	Large Size	Middle Size	Small size
7"*14"(7.5"*14")	+ve	1pc/laminate	2-6pcs/laminate	>6pcs/laminate
	-ve	<6pcs/laminate	7-15pcs/laminate	>15pcs/laminate
14"*16"	+ve	<15pcs/laminate	15-40pcs/laminate	>40pcs/laminate
	-ve	<20pcs/laminate	20-50pcs/laminate	>50pcs/laminate
14.5"*18.5"	+ve	<18pcs/laminate	18-45pcs/laminate	>45pcs/laminate
	-ve	<25pcs/laminate	25-55pcs/laminate	>55pcs/laminate

- 5.0 Reference documents:
- 5.1 VL-QUA-084A;
- 5.2 EI-WKL-980821-01;
- 5.3 EI-LT-980225-01;
- 6.0 Applicable equipment: LCD tester;
- 7.0 Definition of LCD parts:

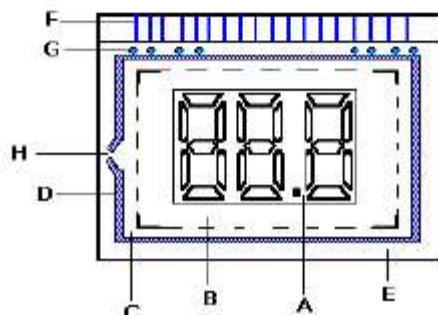





- A : Effective Activated Area;
- B : Viewing Area;
- C : Outside V.A.;
- D : Perimeter Seal;
- E : Out Perimeter Seal;
- F : Contact Leads;
- G : Silver Dot;
- H : End Seal;

7.2 Unless specified, LCD background color will refer to standard color sample;

7.3 Inspection Specification :

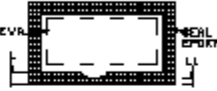

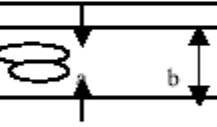
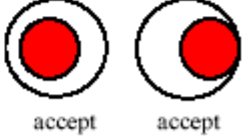

7.3.1 Patterned glass inspection criteria :

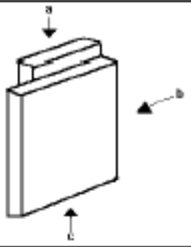
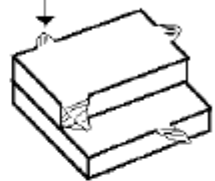
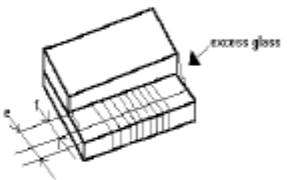
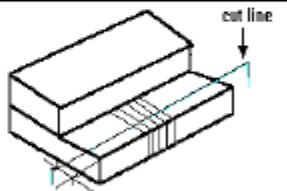
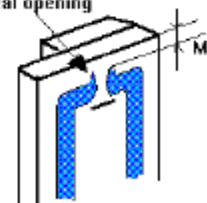
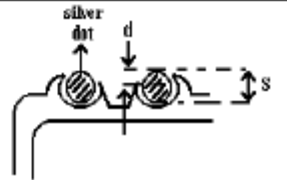

Defect category	Defect description	Scope	Criterion	Drawing Specification
short	Photo-resist coated pattern connected	Patterned area	Can't accept	
open	Photo-resist coated pattern disconnected	Patterned area	Can't accept	
misalignment	Fish eyes misaligned	N/A		
pinhole	Pinhole on photo-resist coating	Patterned area	Can't accept pinhole under sodium lamp with naked eyes	
Excess pattern	Excess photo-resist	Patterned area	Can't accept	
Missing pattern	Incomplete photo-resist	Patterned area	Can't accept	
rainbow	Uneven photo-resist coating	ITO surface	Can't accept colorific defect under sodium lamp with naked eyes	
Black spot	Contaminated by foreign materials	Patterned area	Can't accept foreign material under sodium lamp with naked eyes	
scratch	Scratch on glass surface	Patterned area	Can't accept scratch on EAA	
Chip	Mechanical damage on glass edge/ corner	Patterned area	Can't accept damage on EAA	

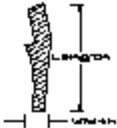
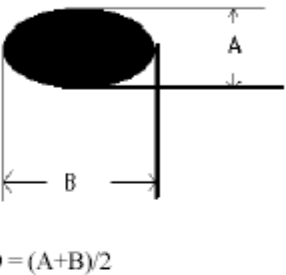
7.3.2 Sodium lamp inspection criteria				
Defect category	Defect description	Scope	Inspection criterion	Drawing Specification
Black sport/ foreign material	Foreign material in glass cell	A,B,C,D	Can't accept Newton ring found by naked eyes under sodium lamp	
scratch	Scratch on glass surface	A,B,C,D	Can't accept glass scratch within EAA zone when it's observed under dark background with naked eyes;	
Perimeter sealing problem	Sealing broken	D	Can't accept	
	Wider sealing width	D	Can't accept sealing exceed scribing line. Refer to the drawing, sealing shouldn't bleed into where between two broken lines;	
	Narrow sealing width	D	If $L1 < 2/3L$, reject; L=normal width of sealing; L1=min width of sealing;	
	Hair going into EVA through perimeter sealing	D	Can't accept	
	Seal epoxy bleeds into EVA	D	Can't accept	
	Bubble in sealing epoxy	D	If $a \leq 1/3b$, reject; a=bulb diameter; b=width of seal epoxy	
Bag broken	Vacuum bag broken	N/A	For STN or Self-short DOT product, can't accept; For TN/HTN or silver dot product, no requirement;	
misalignment	Top & bottom fish eyes misaligned	N/A	Reject if dot and circle intercrossed;	 <p>accept accept</p>
				 <p>reject</p>

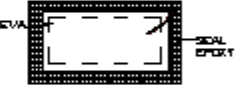
7.3.3 inspection criteria after filling (zone A):

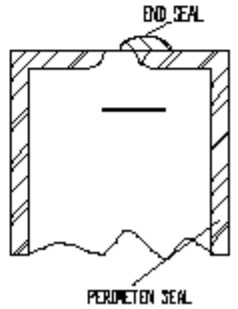
Defect category	Defect description	Scope	Inspection criteria	Drawing Specification
Scribing defect	Anomalous shape is observed on the edge viewing from direction a, b & c;	F,E	Reject if mechanical dimension out of specification;	
	Excess glass within mechanical dimension	F,E	Rework to abrade away the excess glass if possible	
	Excess glass on ITO contact edge	F	Accept if $f < 1/10e$;	 e = width of electrical contact area. f = width of excess glass.
	Scribing on ITO contact lead	F	Cutting line must within specification;	
	Wrong scribing	E	Accept if $M \leq 0\text{mm}$; M= distance between glass edge and seal opening;	
	Silver dot exposed by cutting	F,E	Accept if $d < 1/10s$; d= exposed width of silver dot; s= diameter of silver dot;	

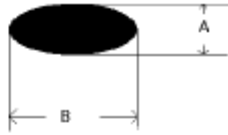
Defect category	Defect description	Scope	Inspection criterion	Drawing Specification
Scratch on glass	Scratch on glass surface	A,B	<u>Length</u> (mm) <u>width</u> (mm) <u>accepted QTY</u>	
			/ <0.02 any	
			<3.0 <0.03 2	
			<5.0 <0.05 1	
			/ >0.05 0	
Bubble	LC does not fulfill the glass cell;	A,B	(a) reject if $D > 0.3\text{mm}$;	 <p>$D = (A+B)/2$</p>
			(b) reject if $0.15\text{mm} < D \leq 0.3\text{mm}$, and QTY ≥ 2 pcs (i.e. max accepted QTY is 1pcs)	
		A,B,C,H	(c) reject if any bubble observed due to leakage of perimeter and/ or end sealing;	
Sealing defect	White/ color mark on perimeter seal	D	Can't accept	
	Hair going into EVA through perimeter seal	A,B,C,D	Can't accept	
	Seal epoxy bleeds into EVA zone	A,B,C,D	Can't accept	
	Narrow seal width	D	Reject if $L1 < 2/3L$; L =width of seal epoxy; $L1$ =min width of seal epoxy;	
	Rainbow near to end seal	H	Can't accept	 <p>END SEAL PERIMETER SEAL</p>
	End seal epoxy does not entirely cover LC filling window;	H	Can't accept	
	End seal depth exceed limits	H	accept if depth $\geq 0.2\text{mm}$ and shall not go into V.A.;	

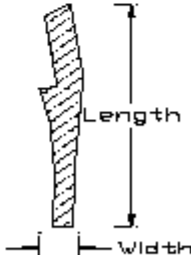
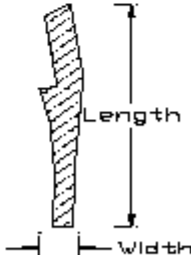
Defect category	Defect description	Scope	Inspection criterion	Drawing Specification																														
Black spot/ foreign material	Black spot, foreign material, polarizer bubble, dent;	A	For large size LCD: Accept if can't find at 1m distance and will not increase under electronic test;	 $D=(A+B)/2$ 																														
			For middle size LCD follow upon below rules; diameter (D: mm) accepted QTY D ≤ 0.15 any 0.15 < D ≤ 0.25 2 0.25 < D ≤ 0.35 1 0.35 < D 0																															
			For small size LCD follow upon below rules; diameter (D: mm) accepted QTY D ≤ 0.15 mm any 0.15 < D ≤ 0.3 mm 1 D > 0.3 mm 0																															
		B	1.5 times of diameter requirement of A area																															
		C	Accept any quantity and size except voids and reverse twist. But the reverse twist can be accept if it happened in zone c without PI coat.																															
White spot(for -ve mode)		A	<u>Large size :</u> <table border="1"> <thead> <tr> <th>Diameter (mm)</th> <th>Acc No.</th> </tr> </thead> <tbody> <tr> <td>D ≤ 0.2</td> <td>Any</td> </tr> <tr> <td>0.2 < D ≤ 0.25</td> <td>3</td> </tr> <tr> <td>0.25 < D ≤ 0.3</td> <td>2</td> </tr> <tr> <td>0.3 < D</td> <td>0</td> </tr> </tbody> </table> <u>Middle size :</u> <table border="1"> <thead> <tr> <th>Diameter (mm)</th> <th>Acc No.</th> </tr> </thead> <tbody> <tr> <td>D ≤ 0.15</td> <td>Any</td> </tr> <tr> <td>0.15 < D ≤ 0.2</td> <td>3</td> </tr> <tr> <td>0.2 < D ≤ 0.25</td> <td>2</td> </tr> <tr> <td>0.25 < D</td> <td>0</td> </tr> </tbody> </table> <u>Small size :</u> <table border="1"> <thead> <tr> <th>Diameter (mm)</th> <th>Acc No.</th> </tr> </thead> <tbody> <tr> <td>D ≤ 0.1</td> <td>Any</td> </tr> <tr> <td>0.1 < D ≤ 0.15</td> <td>3</td> </tr> <tr> <td>0.15 < D ≤ 0.2</td> <td>2</td> </tr> <tr> <td>0.2 < D</td> <td>0</td> </tr> </tbody> </table>	Diameter (mm)	Acc No.	D ≤ 0.2	Any	0.2 < D ≤ 0.25	3	0.25 < D ≤ 0.3	2	0.3 < D	0	Diameter (mm)	Acc No.	D ≤ 0.15	Any	0.15 < D ≤ 0.2	3	0.2 < D ≤ 0.25	2	0.25 < D	0	Diameter (mm)	Acc No.	D ≤ 0.1	Any	0.1 < D ≤ 0.15	3	0.15 < D ≤ 0.2	2	0.2 < D	0	 $D=(A+B)/2$
		Diameter (mm)	Acc No.																															
		D ≤ 0.2	Any																															
0.2 < D ≤ 0.25	3																																	
0.25 < D ≤ 0.3	2																																	
0.3 < D	0																																	
Diameter (mm)	Acc No.																																	
D ≤ 0.15	Any																																	
0.15 < D ≤ 0.2	3																																	
0.2 < D ≤ 0.25	2																																	
0.25 < D	0																																	
Diameter (mm)	Acc No.																																	
D ≤ 0.1	Any																																	
0.1 < D ≤ 0.15	3																																	
0.15 < D ≤ 0.2	2																																	
0.2 < D	0																																	
	B	1.5 times of acceptable largest diameter size of Zone A																																
	C	Accept any quantity and size except voids and reverse twist. But the reverse twist can be accept if it happened in zone c without PI coat.																																
Hair, silk		A	<table border="1"> <thead> <tr> <th>Length (mm)</th> <th>width (mm)</th> <th>accepted QTY(pcs/cm2)</th> </tr> </thead> <tbody> <tr> <td>Any</td> <td><0.02</td> <td>any</td> </tr> <tr> <td><2.0</td> <td><0.03</td> <td>2</td> </tr> <tr> <td><5.0</td> <td><0.05</td> <td>1</td> </tr> <tr> <td>any length</td> <td>>0.05</td> <td>0</td> </tr> </tbody> </table> (available to large, middle & small LCD)	Length (mm)	width (mm)	accepted QTY(pcs/cm2)	Any	<0.02	any	<2.0	<0.03	2	<5.0	<0.05	1	any length	>0.05	0																
		Length (mm)	width (mm)	accepted QTY(pcs/cm2)																														
		Any	<0.02	any																														
<2.0	<0.03	2																																
<5.0	<0.05	1																																
any length	>0.05	0																																
	B	1.5 times of the requirements of A area																																
	C	Accept any quantity and size except voids and reverse twist. But the reverse twist can be accept if it happened in zone c without PI coat.																																
Lines, hairs(for -ve model)		A	<table border="1"> <thead> <tr> <th>Length(mm)</th> <th>Width(mm)</th> <th>Acc No(/cm2)</th> </tr> </thead> <tbody> <tr> <td>Any length</td> <td>≤0.01</td> <td>Any</td> </tr> <tr> <td>≤2.0</td> <td>≤0.02</td> <td>1</td> </tr> <tr> <td>Any length</td> <td>>0.02</td> <td>0</td> </tr> </tbody> </table>	Length(mm)	Width(mm)	Acc No(/cm2)	Any length	≤0.01	Any	≤2.0	≤0.02	1	Any length	>0.02	0																			
		Length(mm)	Width(mm)	Acc No(/cm2)																														
		Any length	≤0.01	Any																														
≤2.0	≤0.02	1																																
Any length	>0.02	0																																
	B	<table border="1"> <thead> <tr> <th>Length(mm)</th> <th>Width(mm)</th> <th>Acc No(/cm2)</th> </tr> </thead> <tbody> <tr> <td>Any length</td> <td>≤0.01</td> <td>Any</td> </tr> <tr> <td>≤3.0</td> <td>≤0.02</td> <td>1</td> </tr> <tr> <td>Any length</td> <td>>0.02</td> <td>0</td> </tr> </tbody> </table>	Length(mm)	Width(mm)	Acc No(/cm2)	Any length	≤0.01	Any	≤3.0	≤0.02	1	Any length	>0.02	0																				
Length(mm)	Width(mm)	Acc No(/cm2)																																
Any length	≤0.01	Any																																
≤3.0	≤0.02	1																																
Any length	>0.02	0																																
	C	Accept any quantity and size except voids and reverse twist. But the reverse twist can be accept if it happened in zone c without PI coat.																																

Remark: the minimum space between any 2 defects (spot, dirt) should ≥ 20mm.

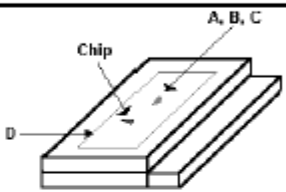
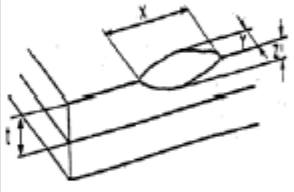
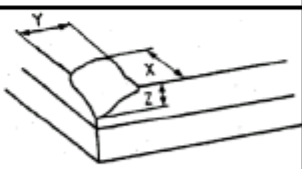
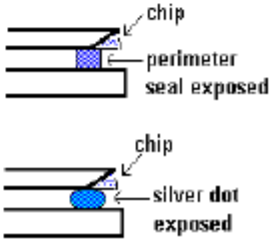
Defect category	Defect description	Scope	Inspection criterion	Drawing Specification
Rainbow (RB)	Arches, circular or parallel colorful spread	A,B	Refer to golden samples	
Fingerprint	Fingerprint on PI coating;	A,B,C	<i>Can't accept;</i>	
Scratch on PI coating	PI coating scratched	A,B	<i>Refer to black spot/ foreign material criteria hereinabove;</i>	
Reverse twist	Visual radialized spots	A,B	Can't accept	
Mechanical damage	Glass chip on corner, edge or surface	A,B,C	Can't accept	
		D,E	Reject if beyond any of following requirements; 1. $X \leq 1/8L$ (L= LCD length of direction X); 2. Y does not extend into EVA; 3. $Z < t$ (t= thickness of LCD glass);	
			Reject if beyond any of following requirements; 1. $X/Y \leq 1/8L$ (L= LCD length of direction X/Y); 2. X/Y does not extend into EVA; 3. $Z < t$ (t= thickness of LCD glass); Notes: accept $Z = t$ if glass thickness $t \leq 0.7\text{mm}$;	
D,G	Reject if beyond any of following requirements; 1. silver dot cannot be exposed; 2. > 50% of sealing frame must remain;			

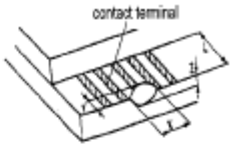
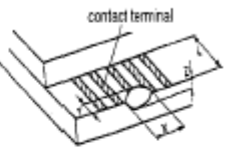
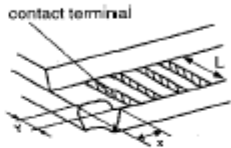
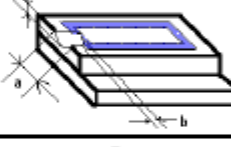
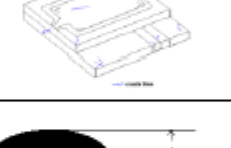
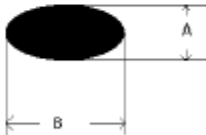
Defect category	Defect description	Scope	Inspection criterion	Drawing Specification
Mechanical damage	Glass chip on ITO ledge (for non-pin and COG model);	F	Reject if beyond any of following requirements; 1. $X \leq 1/8L$ (L= LCD length of direction X); 2. can't exceed 4 ITO lead along direction X; 3. $Y \leq 1/4l$ (l= the length of ITO lead); 4. $Z < 1/2t$ (t= thickness of LCD);	
	Glass chip on ITO ledge (for pin and COG model);	F	Reject if beyond any of following requirements; 1. $X \leq 1/8L$ (L= LCD length of direction X); 2. can't exceed 4 ITO lead along direction X; 3. $Y \leq 1/10l$ (l= the length of ITO lead); 4. $Z < 1/2t$ (t= thickness of LCD);	
	Glass chip on LCD ledge without ITO leads;	F	Reject if beyond any of following requirements; 1. $X \leq 1/8L$ (L= LCD length of direction X); 2. can't extend onto ITO lead or pattern (mark or code); 3. $Y < 1/2l$ (l= the length of ITO lead);	
	Glass chip on end seal	H	Can't accept;	
	Glass crack	A,B,C,D,E,F,G,H	Inspector shall attempt to remove the chip with tweezers; Re-evaluate if the remaining defect is still a crack or a chip, reject any crack;	
Ink printing defect	Glass chip or foreign material affix on ink of glass surface and can't be wiped away;	A,B	If find out of ink pattern, can scrape away by using blade but can't accept any light leakage (refer to definition of light leakage); If find dirt within ink pattern: <u>diameter (D)</u> <u>accepted QTY</u> $D \leq 0.15\text{mm}$ any $0.15 < D \leq 0.3\text{mm}$ 1 $D > 0.3\text{mm}$ 0	 $D = (A+B)/2$
	Ink line/ pattern broken;	A,B	Can't accept	
	<u>Light leakage</u> ; When activated with current white light appears in the position of pinhole or scratch due to ink printing misalignment	A,B	Can't accept any light leakage due to misalignment; <u>For light leakage of pinhole :</u> <u>Diameter (mm)</u> <u>accepted QTY</u> $D \leq 0.15$ any $0.15 < D \leq 0.3$ 1 $D > 0.3$ 0 Space between any 2 points of light leakage $\geq 1\text{mm}$.	
	<u>Ink printing misalignment</u> ; Position of ink printing can't match to drawing	A,B,C,D,E,F,G,H	Accept if the shift of ink printing within tolerance and dimension specified in drawing, otherwise reject; Unless otherwise specified, tolerance of ink printing should be $\pm 0.5\text{mm}$;	
	<u>Thick or thin ink</u> ; Ink printing pattern/ line are thicker or thinner than that specified in drawing	A,B,C	(a)accept if the thick or thin part is less than 10% or $\leq 0.15\text{mm}$; (b)reject if the thick or thin part is more than 10% or $> 0.15\text{mm}$; for thicker ink printing pattern outside EVA, remove away with blade; reject if the thicker ink pattern within EVA;	

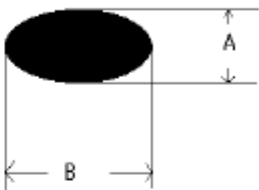
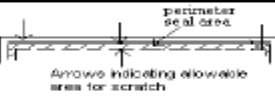
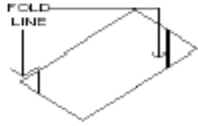

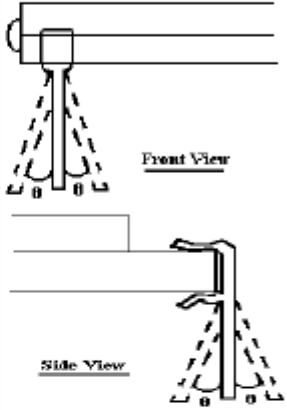
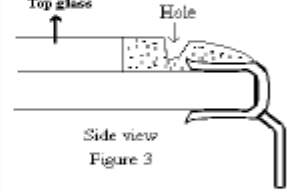
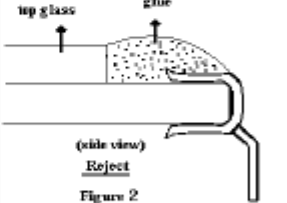
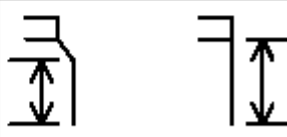
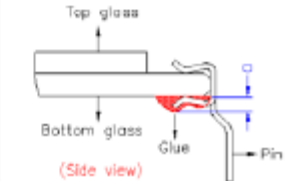
Defect category	Defect description	Scope	Inspection criterion	Drawing Specification
Ink printing defect	Ink pattern/ line jagged;	A,B	(a) accept if the thick or thin part is less than 10% or $\leq 0.15\text{mm}$; (b) reject if the thick or thin part is more than 10% or $> 0.15\text{mm}$;	
	<u>Uneven printing ink color:</u> Color of ink darker or lighter;	A,B	Reject if printing color is darker or lighter than limits samples;	
	<u>Stencil dilapidation:</u> Dilapidation result in ink leakage;	A,B	<u>Point outline:</u> <u>diameter</u> <u>accepted QTY</u> $D \leq 0.15\text{mm}$ any $0.15 < A \leq 0.3\text{mm}$ 1 $D > 0.3\text{mm}$ 0	 <p>$D = (A+B)/2$</p>
Date code printing defect	Date code defect of printed pattern : wrong pattern, fuzzy pattern, misalignment, etc.;	Printing area	Reject if any wrong pattern and misalignment; Reject if any fuzzy pattern being difficult to identify;(Pls. Refer to limit sample if there is.)	
Polarizer defect	Scratch on transmissive polarizer	A,B	Reject if scratch within EVA;	 <p>perimeter seal area</p> <p>Arrows indicating allowable area for scratch</p>
		C	Accept if scratch outside EVA;	
	Scratch on reflective polarizer	A,B,C	Accept if scratch length $< 2\text{mm}$; Accept if QTY of scratch ≤ 2 ; Accept if scratch can't be viewed from the top of transmissive polarizer side;	
	Scratch on transfective polarizer	A,B,C	Reject if scratch can be viewed from front light source	
	Folding line	A,B	Reject if folding line on transmissive polarizer; Invisible folding line on transfective or reflective polarizer is acceptable;	 <p>FOLD LINE</p>
	Mechanical damage	A,B	Reject any mechanical damage, like as dent mark, through pinhole, etc.;	
		C	Accept minor dent mark; Reject serious dent mark, like as through hole, etc.;	
discoloration	A,B,C	Can't accept		
Wrong or reversed polarizer;	N/A	Can't accept		
Polarizer shift or protrude from the edge of glass;	N/A	Reject if polarizer protruding and out of glass; For the polarizer shift but within glass frame; Reject if exposed seal epoxy outline; Accept if not exposed seal epoxy outline;		

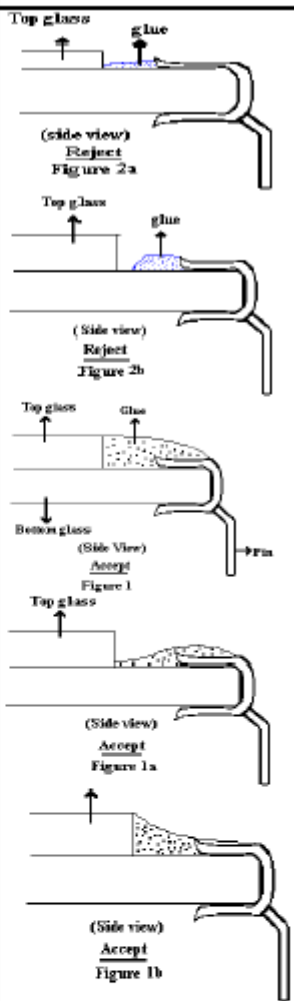
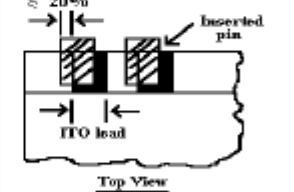
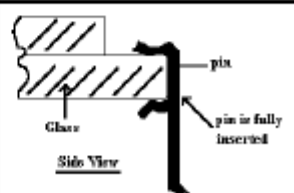
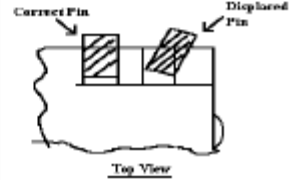
Defect category	Defect description	Scope	Inspection criterion	Drawing Specification
Polarizer defect	polarizer lamination	N/A	Can't accept	
	Wrong type applied	N/A	Can't accept	
	Missing protective film	N/A	Reject if missing protective film after polarizer applied (except specified requirement from customer)	
Pin attachment defect	<u>Pin incoming defect.</u> Oxidized, damage (including pins plating damaged);	N/A	Can't accept	
	Distorted pins;	N/A	Reject if the bend/ twist angle $\theta > 5^\circ$	
	Pin epoxy cracked;	N/A	Can't accept if hole as illustration	
	Pin epoxy be over the to polarizer surface;	N/A	Can't accept	
	Pin epoxy that flows onto pins;	N/A	Reject if epoxy extend onto the area pointed by arrows as in illustration;	
	Epoxy on polarizer	N/A	Can't accept	
	Excess epoxy on bottom glass	N/A	Reject if the thickness of bottom epoxy more than 1.0mm. If $D > 1.0\text{mm}$, it should be reject.	

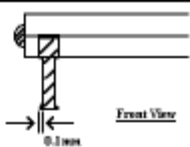
Defect category	Defect description	Scope	Inspection criterion	Drawing Specification
Pin attachment defect	Insufficient top epoxy	N/A	Epoxy must fully flow onto lead in the vertical direction of glass ; Showing as in right illustration, accept top 2 and reject bottom 3;	 <p>Top glass glue (side view) Reject Figure 2a</p> <p>Top glass glue (Side view) Reject Figure 2b</p> <p>Top glass glue Bottom glass (Side View) Accept Figure 1</p> <p>Top glass (Side view) Accept Figure 1a</p> <p>(Side view) Accept Figure 1b</p>
Pins overhang; Pin located out of designed position;		N/A	Lead must be located on ITO lead: Reject if pins overhang is more than 20% of width of ITO contactor;	 <p>$\leq 20\%$ Inserted pin ITO lead Top View</p>
Pin is not well contacted with ITO leads;		N/A	Lead must be fully inserted and fix LCD tightly	 <p>Glass pin pin is fully inserted Side View</p>
Pin displaced		N/A	Rejected if any pin displacement as illustration;	 <p>Correct Pin Displaced Pin Top View</p>

Defect category	Defect description	Scope	Inspection criterion	Drawing Specification
Pin attachment defect	Incorrect pin length;	N/A	Reject if pin length can't match to spec in drawing	
	Burr	N/A	Reject if the length of protrusion is more than 0.1mm;	
	Incorrect pins quantity;	N/A	Reject any more or less than requirement in drawing	
	Bent angle and outline can't meet specification;	N/A	Reject any no bent or bent lead can't meet specification (available to where pin bending is required);	
	Incorrect pin type;	N/A	Can't accept	

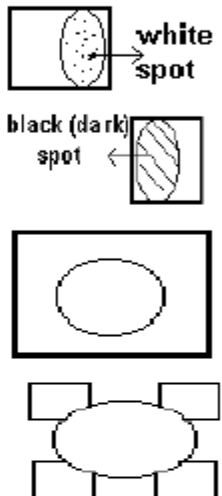
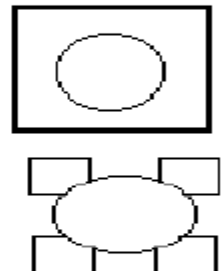
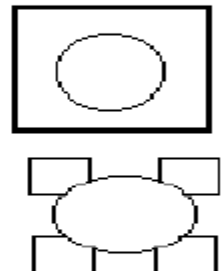
7.3.4 Criteria for functional test after LC filling:

Defect category	Defect description	Scope	Inspection criterion	Drawing Specification										
Fake zero	Black dot/ spot disappear at activated state;	A	Refer to cosmetics criteria of black spot/ foreign material hereinabove;											
			<p>Large size LCD:</p> <table border="1"> <tr> <th>diameter (mm)</th> <th>accepted QTY</th> </tr> <tr> <td>$D \leq 0.2$</td> <td>Any</td> </tr> <tr> <td>$0.2 < D \leq 0.25$</td> <td>3</td> </tr> <tr> <td>$0.25 < D \leq 0.3$</td> <td>2</td> </tr> <tr> <td>$0.3 < D$</td> <td>0</td> </tr> </table>		diameter (mm)	accepted QTY	$D \leq 0.2$	Any	$0.2 < D \leq 0.25$	3	$0.25 < D \leq 0.3$	2	$0.3 < D$	0
			diameter (mm)		accepted QTY									
$D \leq 0.2$	Any													
$0.2 < D \leq 0.25$	3													
$0.25 < D \leq 0.3$	2													
$0.3 < D$	0													
<p>Middle size LCD:</p> <table border="1"> <tr> <th>diameter (mm)</th> <th>accepted QTY</th> </tr> <tr> <td>$D \leq 0.15$</td> <td>Any</td> </tr> <tr> <td>$0.15 < D \leq 0.2$</td> <td>3</td> </tr> <tr> <td>$0.2 < D \leq 0.25$</td> <td>2</td> </tr> <tr> <td>$0.25 < D$</td> <td>0</td> </tr> </table>	diameter (mm)	accepted QTY	$D \leq 0.15$	Any	$0.15 < D \leq 0.2$	3	$0.2 < D \leq 0.25$	2	$0.25 < D$	0				
diameter (mm)	accepted QTY													
$D \leq 0.15$	Any													
$0.15 < D \leq 0.2$	3													
$0.2 < D \leq 0.25$	2													
$0.25 < D$	0													
<p>Small size LCD:</p> <table border="1"> <tr> <th>diameter (mm)</th> <th>accepted QTY</th> </tr> <tr> <td>$D \leq 0.1$</td> <td>Any</td> </tr> <tr> <td>$0.1 < D \leq 0.15$</td> <td>3</td> </tr> <tr> <td>$0.15 < D \leq 0.2$</td> <td>2</td> </tr> <tr> <td>$0.2 < D$</td> <td>0</td> </tr> </table>	diameter (mm)	accepted QTY	$D \leq 0.1$	Any	$0.1 < D \leq 0.15$	3	$0.15 < D \leq 0.2$	2	$0.2 < D$	0				
diameter (mm)	accepted QTY													
$D \leq 0.1$	Any													
$0.1 < D \leq 0.15$	3													
$0.15 < D \leq 0.2$	2													
$0.2 < D$	0													
B	1.5 times of diameter requirement of A area													
C	Accept any quantity and size except voids and reverse twist. But the reverse twist can be accept if it happened in zone c without PI coat.													
Black spot/ pinhole at activated state	white spot at activated state;(for negative mode)	A	<p>Large size LCD:</p> <table border="1"> <tr> <th>diameter (mm)</th> <th>accepted QTY</th> </tr> <tr> <td>$D \leq 0.15$</td> <td>any</td> </tr> <tr> <td>$0.15 < D \leq 0.3$</td> <td>5</td> </tr> <tr> <td>$0.3 < D \leq 0.4$</td> <td>2</td> </tr> <tr> <td>$0.4 < D$</td> <td>0</td> </tr> </table>	diameter (mm)	accepted QTY	$D \leq 0.15$	any	$0.15 < D \leq 0.3$	5	$0.3 < D \leq 0.4$	2	$0.4 < D$	0	
			diameter (mm)	accepted QTY										
			$D \leq 0.15$	any										
$0.15 < D \leq 0.3$	5													
$0.3 < D \leq 0.4$	2													
$0.4 < D$	0													
<p>Middle size LCD:</p> <table border="1"> <tr> <th>diameter (mm)</th> <th>accepted QTY</th> </tr> <tr> <td>$D \leq 0.15$</td> <td>any</td> </tr> <tr> <td>$0.15 < D \leq 0.25$</td> <td>2</td> </tr> <tr> <td>$0.25 < D \leq 0.35$</td> <td>1</td> </tr> <tr> <td>$0.35 < D$</td> <td>0</td> </tr> </table>	diameter (mm)	accepted QTY	$D \leq 0.15$	any	$0.15 < D \leq 0.25$	2	$0.25 < D \leq 0.35$	1	$0.35 < D$	0				
diameter (mm)	accepted QTY													
$D \leq 0.15$	any													
$0.15 < D \leq 0.25$	2													
$0.25 < D \leq 0.35$	1													
$0.35 < D$	0													
<p>Small size LCD:</p> <table border="1"> <tr> <th>diameter (mm)</th> <th>accepted QTY</th> </tr> <tr> <td>$D \leq 0.15$</td> <td>any</td> </tr> <tr> <td>$0.15 < D \leq 0.3$</td> <td>1</td> </tr> <tr> <td>$0.3 < D$</td> <td>0</td> </tr> </table>	diameter (mm)	accepted QTY	$D \leq 0.15$	any	$0.15 < D \leq 0.3$	1	$0.3 < D$	0						
diameter (mm)	accepted QTY													
$D \leq 0.15$	any													
$0.15 < D \leq 0.3$	1													
$0.3 < D$	0													
B	1.5 times of diameter requirement of A area													
C	Accept any quantity and size except voids and reverse twist. But the reverse twist can be accept if it happened in zone c without PI coat.													
Black spot/ pinhole at activated state	black spot/pin hole at activated state;(for positive mode)	A	<p>Large size LCD:</p> <table border="1"> <tr> <th>diameter (mm)</th> <th>accepted QTY</th> </tr> <tr> <td>$D \leq 0.15$</td> <td>any</td> </tr> <tr> <td>$0.15 < D \leq 0.3$</td> <td>5</td> </tr> <tr> <td>$0.3 < D \leq 0.4$</td> <td>2</td> </tr> <tr> <td>$0.4 < D$</td> <td>0</td> </tr> </table>	diameter (mm)	accepted QTY	$D \leq 0.15$	any	$0.15 < D \leq 0.3$	5	$0.3 < D \leq 0.4$	2	$0.4 < D$	0	
			diameter (mm)	accepted QTY										
$D \leq 0.15$	any													
$0.15 < D \leq 0.3$	5													
$0.3 < D \leq 0.4$	2													
$0.4 < D$	0													
<p>Middle size LCD:</p> <table border="1"> <tr> <th>diameter (mm)</th> <th>accepted QTY</th> </tr> <tr> <td>$D \leq 0.15$</td> <td>any</td> </tr> <tr> <td>$0.15 < D \leq 0.25$</td> <td>2</td> </tr> <tr> <td>$0.25 < D \leq 0.35$</td> <td>1</td> </tr> <tr> <td>$0.35 < D$</td> <td>0</td> </tr> </table>	diameter (mm)	accepted QTY	$D \leq 0.15$	any	$0.15 < D \leq 0.25$	2	$0.25 < D \leq 0.35$	1	$0.35 < D$	0				
diameter (mm)	accepted QTY													
$D \leq 0.15$	any													
$0.15 < D \leq 0.25$	2													
$0.25 < D \leq 0.35$	1													
$0.35 < D$	0													
B	1.5 times of diameter requirement of A area													
C	Accept any quantity and size except voids and reverse twist. But the reverse twist can be accept if it happened in zone c without PI coat.													
Black spot/ pinhole at activated state	Dot matrix	A	Accept if $X/Y \leq 2/3L/H$ or $\leq 0.2\text{mm}$ (judge as max. 1 of X/Y); X/Y: length/ height of pinhole; L/H: length/ height of matrix dot;											

Remark: the minimum space between any 2 defects (dot, dirt) should $\geq 20\text{mm}$,

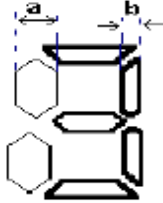
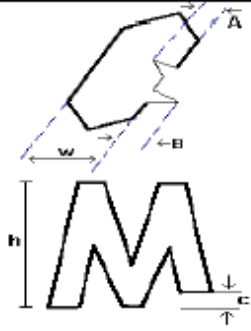
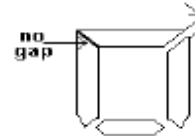
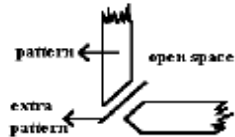
Defect category	Defect description	Affect area	Inspection criteria	illustration
COMMON open	Part or all pattern do not light up;	N/A	Can't accept	
SEGMENT open	1 or few pattern segment do not light up;	N/A	Can't accept	
Pattern deformation	Segment fatter or smaller;	N/A	Reject if $ (a-b) / b \geq 20\%$	
	Pattern deformation	N/A	Reject if A or B > 0.1mm, or; Reject if A or B > 20%W; A/B: width of missing or excess pattern; W: width of designed pattern; Reject if C > 0.2mm, or; Reject if C > 1/8H; C: height of missing or excess pattern; H: height of designed pattern;	
	The gap width between patterns out of limit;	N/A	Reject if a < 0.1mm; Reject if a > 0.3mm; a: gap between pattern;	
	Black line between segments	N/A	Reject if black line is found at distance of 30cm; For game application, accept if it does not affect the visibility;	
COM-COM short	COM-COM electrode connected	N/A	Can't accept	
SEG-SEG short	SEG-SEG electrode connected	N/A	Can't accept	
COM-SEG short	COM-SEG electrode connected	N/A	Can't accept	
Darker/ lighter	Pattern darker or lighter than standard sample at activated state;	N/A	Ref.to standard or limit sample	
High current	Current exceed designed value;	N/A	When power on, the pointer of short-circuit tester swing to max and then back, while the indicator lights up then goes out;	
Black & white mark/bevel wave	Black &white mark or spraying/bevel wave etc. at activated state	N/A	Refer to standard or limit sample	
Black & white Line	Black &white line at activated state	N/A	Refer to above related black&white line criteria on cosmetic defect	



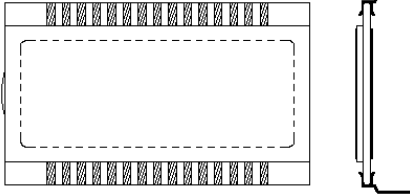

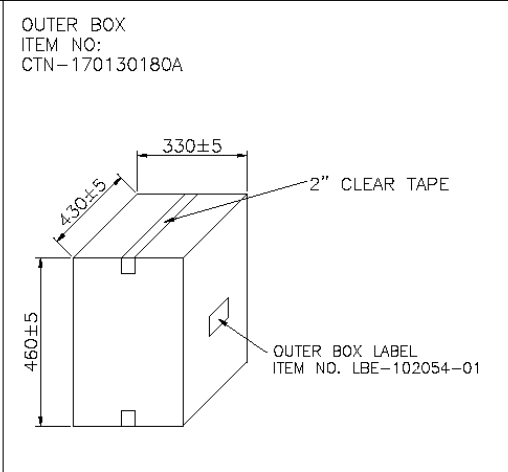
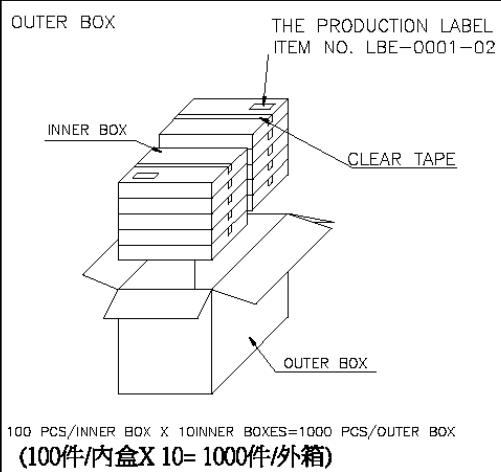
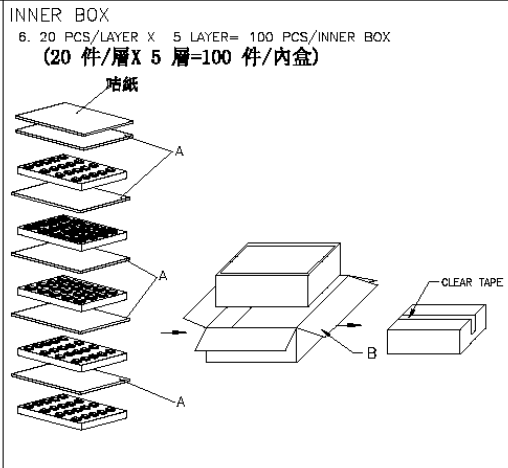
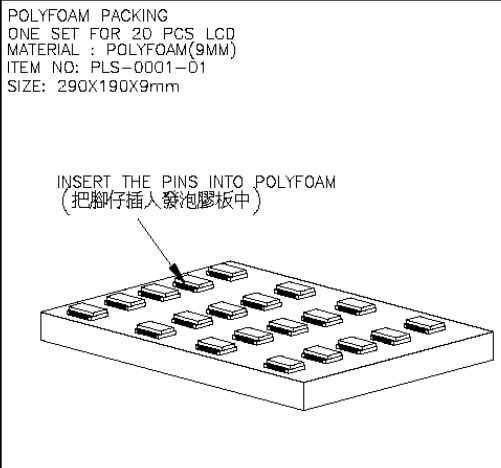

6. Package drawing

CONFIGURATION : LCD SIZE: L50.8X W30.48 X T2.8			ISSUE	AMENDMENT	DATE
					
D	VIM_503_V01	LCD	1000pcs	50.8X30.48X2.8	
C	PLS-0001-01	POLYFOAM SHEET	50	290X190X9	
B	CTN-120080030C	INNER BOX	10	300X200X76	
A	SPE-0002	SPONGE	50	290X190X2	
No.	Item No.	Name	Qty/ outer box	Size	

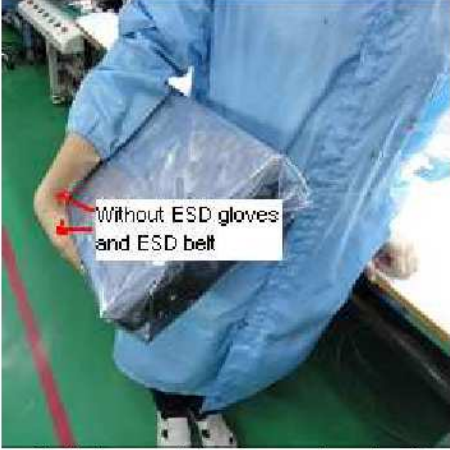

TITLE: PACKAGE DRAWING				 VARITRONIX LIMITED	
3rd ANGLE PROJECTION	UNIT MM	SCALE DO NOT ON SCALE			
DRAWN	NAME LIML	SIGN	DATE	MODEL: VIM_503_V01	REV 0
CHECK	NAME XYW			DRAWING NO.: PD-VIM_503_V01	DATE 2012-09-11
CHECK					
APPROVAL	NAME TONY CAO				SHEET 1 OF 1

7. Packing removal and handling requirement

Requirement	Wrong	Correct
<p>Get one package each times & hold the package by both hands with proper ESD shielding</p>	 <p>Without ESD gloves and ESD belt</p> <p>Hold the modules by one hand and without proper ESD shielding (Fail)</p>	 <p>Anti ESD gloves Anti ESD belt</p> <p>Hold the modules by both hands (Pass)</p>
<p>Prohibit to stack inner package over 3 layers</p>	 <p>Over 3 layers (Fail)</p>	 <p>Not exceed 3 layers (Pass)</p>
<p>Total packing tray height must within 40 cm</p>	 <p>packing tray over 40 cm</p> <p>Over 40 cm (Fail)</p>	 <p>40 CM</p> <p>Lower than 40 cm (Pass)</p>

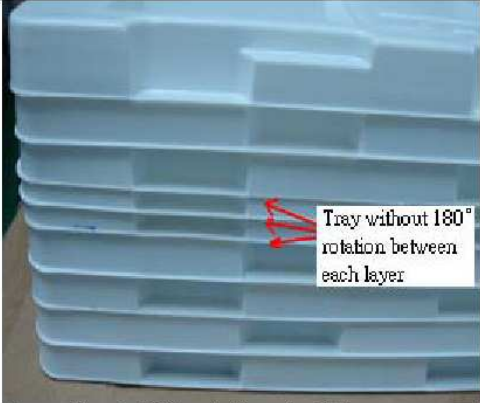
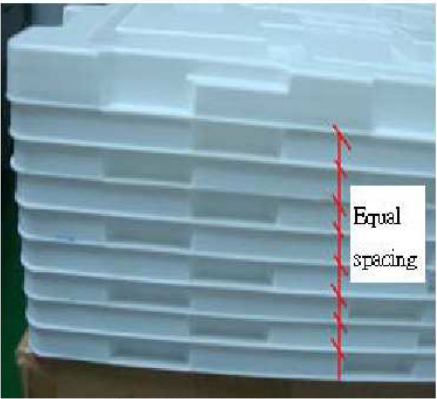
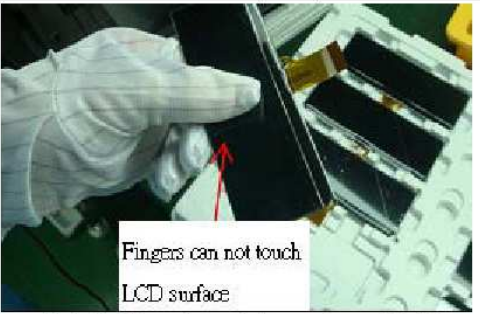
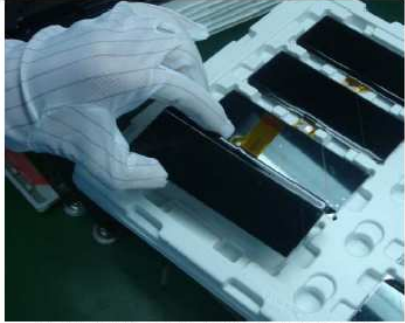
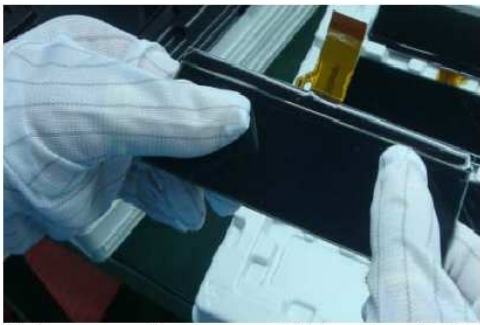
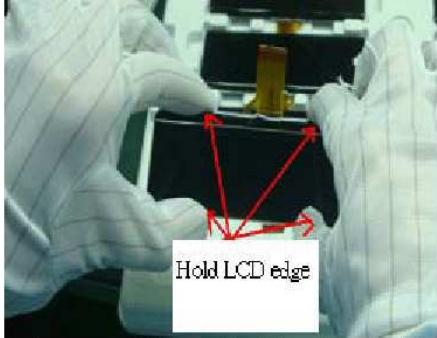
Requirement	Wrong	Correct
Packing tray must rotate 180° in each layer when stack together	 <p>Tray without 180° rotation between each layer</p> <p>Tray without 180° rotation, It will have pressure on the module (Fail)</p>	 <p>Equal spacing</p> <p>Tray with 180° rotation (Pass)</p>
Prohibit to touch LCD surface by fingers	 <p>Fingers can not touch LCD surface</p> <p>Hold LCD and touch its surface (Fail)</p>	 <p>Hold LCD edge by hand (Pass)</p>
During assembly, prohibit to press on LCD surface by fingers, Must hold the LCD edges by both hands	 <p>During assembly, press on LCD surface (Fail)</p>	 <p>Hold LCD edge</p> <p>During assembly, use both hands to hold LCD edge only (Pass)</p>

Remark: For all ISTN display, it is extremely sensitive to external pressure, beside above handling requirement, special care to avoid pressure application on LCD surface is necessary.

"Varitronix Limited reserves the right to change this specification."

Tel:(852) 2197-6000

Fax:(852) 2343-9555.

URL:<http://www.varitronix.com>

- END -