

EVALUATION KIT  
AVAILABLE

# 1.8V, 12-Bit, 170Mps ADC for Broadband Applications

MAX1213

## General Description

The MAX1213 is a monolithic, 12-bit, 170Mps analog-to-digital converter (ADC) optimized for outstanding dynamic performance at high-IF frequencies up to 300MHz. The product operates with conversion rates up to 170Mps while consuming only 788mW.

At 170Mps and an input frequency up to 250MHz, the MAX1213 achieves a spurious-free dynamic range (SFDR) of 72.9dBc. Its excellent signal-to-noise ratio (SNR) of 66.2dB at 10MHz remains flat (within 2dB) for input tones up to 250MHz. This ADC yields an excellent low-noise floor of -68dBFS, which makes it ideal for wideband applications such as cable head-end receivers and power-amplifier predistortion in cellular base-station transceivers.

The MAX1213 requires a single 1.8V supply. The analog input is designed for either differential or single-ended operation and can be AC- or DC-coupled. The ADC also features a selectable on-chip divide-by-2 clock circuit, which allows the user to apply clock frequencies as high as 340MHz. This helps to reduce the phase noise of the input clock source. A low-voltage differential signal (LVDS) sampling clock is recommended for best performance. The converter's digital outputs are LVDS compatible and the data format can be selected to be either two's complement or offset binary.

The MAX1213 is available in a 68-pin QFN package with exposed paddle (EP) and is specified over the industrial (-40°C to +85°C) temperature range.

See the *Pin-Compatible Versions* table for a complete selection of 8-bit, 10-bit, and 12-bit high-speed ADCs in this family (with and without input buffers).

## Applications

Base-Station Power-Amplifier Linearization  
Cable Head-End Receivers  
Wireless and Wired Broadband Communication  
Communications Test Equipment  
Radar and Satellite Subsystems

*Pin Configuration appears at end of data sheet.*

## Features

- ◆ 170Mps Conversion Rate
- ◆ Low Noise Floor of -68dBFS
- ◆ Excellent Low-Noise Characteristics
  - SNR = 65.8dB at  $f_{IN} = 100\text{MHz}$
  - SNR = 64.5dB at  $f_{IN} = 250\text{MHz}$
- ◆ Excellent Dynamic Range
  - SFDR = 74dBc at  $f_{IN} = 100\text{MHz}$
  - SFDR = 72.9dBc at  $f_{IN} = 250\text{MHz}$
- ◆ 59.5dB NPR for  $f_{NOTCH} = 28.8\text{MHz}$  and a Noise Bandwidth of 50MHz
- ◆ Single 1.8V Supply
- ◆ 788mW Power Dissipation at  $f_{SAMPLE} = 170\text{MHz}$  and  $f_{IN} = 65\text{MHz}$
- ◆ On-Chip Track-and-Hold Amplifier
- ◆ Internal 1.23V-Bandgap Reference
- ◆ On-Chip Selectable Divide-by-2 Clock Input
- ◆ LVDS Digital Outputs with Data Clock Output
- ◆ MAX1213 EV Kit Available

## Ordering Information

PART	TEMP RANGE	PIN-PACKAGE
MAX1213EGK-D	-40°C to +85°C	68 QFN-EP*
MAX1213EGK+D	-40°C to +85°C	68 QFN-EP*

-Denotes a package containing lead(Pb).

+Denotes a lead(Pb)-free/RoHS-compliant package.

\*EP = Exposed paddle.

D = Dry pack.

## Pin-Compatible Versions

PART	RESOLUTION (BITS)	SPEED GRADE (Mps)	ON-CHIP BUFFER
MAX1121	8	250	Yes
MAX1122	10	170	Yes
MAX1123	10	210	Yes
MAX1124	10	250	Yes
MAX1213	12	170	Yes
MAX1214	12	210	Yes
MAX1215	12	250	Yes
MAX1213N	12	170	No
MAX1214N	12	210	No
MAX1215N	12	250	No



# 1.8V, 12-Bit, 170Mps ADC for Broadband Applications

## ABSOLUTE MAXIMUM RATINGS

AV <sub>CC</sub> to AGND .....	-0.3V to +2.1V	Continuous Power Dissipation (T <sub>A</sub> = +70°C, multilayer board)
OV <sub>CC</sub> to OGND .....	-0.3V to +2.1V	68-Pin QFN-EP (derate 41.7mW/°C
AV <sub>CC</sub> to OV <sub>CC</sub> .....	-0.3V to +2.1V	above +70°C).....
AGND to OGND .....	-0.3V to +0.3V	3333mW/°C
INP, INN to AGND .....	-0.3V to (AV <sub>CC</sub> + 0.3V)	Operating Temperature Range .....
REFIO, REFADJ to AGND .....	-0.3V to (AV <sub>CC</sub> + 0.3V)	-40°C to +85°C
All Digital Inputs to AGND .....	-0.3V to (AV <sub>CC</sub> + 0.3V)	Junction Temperature .....
All Digital Outputs to OGND .....	-0.3V to (OV <sub>CC</sub> + 0.3V)	+150°C
		Storage Temperature Range .....
		-60°C to +150°C
		Maximum Current into Any Pin .....
		±50mA
		Lead Temperature (soldering, 10s) .....
		+300°C

Stresses beyond those listed under "Absolute Maximum Ratings" may cause permanent damage to the device. These are stress ratings only, and functional operation of the device at these or any other conditions beyond those indicated in the operational sections of the specifications is not implied. Exposure to absolute maximum rating conditions for extended periods may affect device reliability.

## ELECTRICAL CHARACTERISTICS

(AV<sub>CC</sub> = OV<sub>CC</sub> = 1.8V, AGND = OGND = 0, f<sub>SAMPLE</sub> = 170MHz, differential sine-wave clock input drive, 0.1µF capacitor on REFIO, internal reference, digital output pins differential R<sub>L</sub> = 100Ω ±1%, T<sub>A</sub> = T<sub>MIN</sub> to T<sub>MAX</sub>, unless otherwise noted. Typical values are at T<sub>A</sub> = +25°C.) (Note 1)

PARAMETER	SYMBOL	CONDITIONS	MIN	TYP	MAX	UNITS
<b>DC ACCURACY</b>						
Resolution			12			Bits
Integral Nonlinearity (Note 2)	INL	f <sub>IN</sub> = 10MHz, T <sub>A</sub> = +25°C	-2	±0.75	+2	LSB
Differential Nonlinearity (Note 2)	DNL	T <sub>A</sub> = +25°C, No missing codes	-0.8	±0.3	+0.8	LSB
Transfer Curve Offset	V <sub>OS</sub>	T <sub>A</sub> = +25°C (Note 2)	-3.3		+3.3	mV
Offset Temperature Drift				40		µV/°C
<b>ANALOG INPUTS (INP, INN)</b>						
Full-Scale Input Voltage Range	V <sub>FS</sub>	T <sub>A</sub> = +25°C (Note 2)	1320	1454	1590	mV <sub>P-P</sub>
Full-Scale Range Temperature Drift				130		ppm/°C
Common-Mode Input Range	V <sub>CM</sub>	Internally self-biased		1.365 ±0.15		V
Input Capacitance	C <sub>IN</sub>			2.5		pF
Differential Input Resistance	R <sub>IN</sub>		3.00	4.2	6.25	kΩ
Full-Power Analog Bandwidth	FPBW			700		MHz
<b>REFERENCE (REFIO, REFADJ)</b>						
Reference Output Voltage	V <sub>REFIO</sub>	T <sub>A</sub> = +25°C, REFADJ = AGND	1.18	1.23	1.30	V
Reference Temperature Drift				90		ppm/°C
REFADJ Input High Voltage	V <sub>REFADJ</sub>	Used to disable the internal reference	AV <sub>CC</sub> - 0.1			V
<b>SAMPLING CHARACTERISTICS</b>						
Maximum Sampling Rate	f <sub>SAMPLE</sub>		170			MHz
Minimum Sampling Rate	f <sub>SAMPLE</sub>			20		MHz
Clock Duty Cycle		Set by clock-management circuit		40 to 60		%
Aperture Delay	t <sub>AD</sub>	Figures 4, 11		620		ps
Aperture Jitter	t <sub>AJ</sub>	Figure 11		0.2		ps <sub>RMS</sub>

# 1.8V, 12-Bit, 170MSPS ADC for Broadband Applications

MAX1213

## ELECTRICAL CHARACTERISTICS (continued)

( $V_{CC} = OV_{CC} = 1.8V$ ,  $AGND = OGND = 0$ ,  $f_{SAMPLE} = 170MHz$ , differential sine-wave clock input drive, 0.1 $\mu F$  capacitor on REFIO, internal reference, digital output pins differential  $R_L = 100\Omega \pm 1\%$ ,  $T_A = T_{MIN}$  to  $T_{MAX}$ , unless otherwise noted. Typical values are at  $T_A = +25^\circ C$ .) (Note 1)

PARAMETER	SYMBOL	CONDITIONS	MIN	TYP	MAX	UNITS
<b>CLOCK INPUTS (CLKP, CLKN)</b>						
Differential Clock Input Amplitude		(Note 3)	200	500		mV <sub>p-p</sub>
Clock Input Common-Mode Voltage Range		Internally self-biased		1.15 $\pm$ 0.25		V
Clock Differential Input Resistance	$R_{CLK}$			11 $\pm$ 25%		k $\Omega$
Clock Differential Input Capacitance	$C_{CLK}$			5		pF
<b>DYNAMIC CHARACTERISTICS (at -1dBFS)</b>						
Signal-to-Noise Ratio	SNR	$f_{IN} = 10MHz$ , $T_A \geq +25^\circ C$	64.5	66.2		dB
		$f_{IN} = 100MHz$ , $T_A \geq +25^\circ C$	64.5	65.8		
		$f_{IN} = 200MHz$		65		
		$f_{IN} = 250MHz$		64.5		
Signal-to-Noise and Distortion	SINAD	$f_{IN} = 10MHz$ , $T_A \geq +25^\circ C$	64.0	65.9		dB
		$f_{IN} = 100MHz$ , $T_A \geq +25^\circ C$	63.5	65.2		
		$f_{IN} = 200MHz$		63.9		
		$f_{IN} = 250MHz$		63.5		
Spurious-Free Dynamic Range	SFDR	$f_{IN} = 10MHz$ , $T_A \geq +25^\circ C$	73	83.0		dBc
		$f_{IN} = 100MHz$ , $T_A \geq +25^\circ C$	69	74.0		
		$f_{IN} = 200MHz$		70.7		
		$f_{IN} = 250MHz$		72.9		
Worst Harmonics (HD2 or HD3)		$f_{IN} = 10MHz$ , $T_A \geq +25^\circ C$		-85	-73	dBc
		$f_{IN} = 100MHz$ , $T_A \geq +25^\circ C$		-74	-69.0	
		$f_{IN} = 200MHz$		-70.7		
		$f_{IN} = 250MHz$		-72.9		
Two-Tone Intermodulation Distortion	TTIMD	$f_{IN1} = 99MHz$ at -7dBFS, $f_{IN2} = 101MHz$ at -7dBFS		-78		dBc
Noise Power Ratio	NPR	$f_{NOTCH} = 28.8MHz \pm 1MHz$ , noise BW = 50MHz, $A_{IN} = -9.1dBFS$		59.5		dB
<b>LVDS DIGITAL OUTPUTS (D0P/N-D11P/N, ORP/N)</b>						
Differential Output Voltage	$IV_{ODI}$	$R_L = 100\Omega \pm 1\%$	250		400	mV
Output Offset Voltage	$OV_{OS}$	$R_L = 100\Omega \pm 1\%$	1.125		1.310	V

# 1.8V, 12-Bit, 170MSPS ADC for Broadband Applications

## ELECTRICAL CHARACTERISTICS (continued)

( $AV_{CC} = OV_{CC} = 1.8V$ ,  $AGND = OGND = 0$ ,  $f_{SAMPLE} = 170MHz$ , differential sine-wave clock input drive,  $0.1\mu F$  capacitor on REFIO, internal reference, digital output pins differential  $R_L = 100\Omega \pm 1\%$ ,  $T_A = T_{MIN}$  to  $T_{MAX}$ , unless otherwise noted. Typical values are at  $T_A = +25^\circ C$ .) (Note 1)

PARAMETER	SYMBOL	CONDITIONS	MIN	TYP	MAX	UNITS
<b>LVC MOS DIGITAL INPUTS (CLKDIV, <math>\bar{T}/B</math>)</b>						
Digital Input Voltage Low	$V_{IL}$			$0.2 \times AV_{CC}$		V
Digital Input Voltage High	$V_{IH}$		$0.8 \times AV_{CC}$			V
<b>TIMING CHARACTERISTICS</b>						
CLK-to-Data Propagation Delay	$t_{PDL}$	Figure 4		1.75		ns
CLK-to-DCLK Propagation Delay	$t_{CPDL}$	Figure 4		4.95		ns
DCLK-to-Data Propagation Delay	$t_{PDL} - t_{CPDL}$	Figure 4 (Note 3)	2.8	3.2	3.6	ns
LVDS Output Rise Time	$t_{RISE}$	20% to 80%, $C_L = 5pF$		460		ps
LVDS Output Fall Time	$t_{FALL}$	20% to 80%, $C_L = 5pF$		460		ps
Output Data Pipeline Delay	$t_{LATENCY}$	Figure 4		11		Clock cycles
<b>POWER REQUIREMENTS</b>						
Analog Supply Voltage Range	$AV_{CC}$		1.70	1.80	1.90	V
Digital Supply Voltage Range	$OV_{CC}$		1.70	1.80	1.90	V
Analog Supply Current	$I_{AVCC}$	$f_{IN} = 65MHz$		375	425	mA
Digital Supply Current	$I_{OVCC}$	$f_{IN} = 65MHz$		63	75	mA
Analog Power Dissipation	$P_{DISS}$	$f_{IN} = 65MHz$		788	900	mW
Power-Supply Rejection Ratio (Note 4)	PSRR	Offset		1.8		mV/V
		Gain		1.5		%FS/V

**Note 1:**  $\geq +25^\circ C$  guaranteed by production test,  $< +25^\circ C$  guaranteed by design and characterization.

**Note 2:** Static linearity and offset parameters are computed from a best-fit straight line through the code transition points. The full-scale range (FSR) is defined as  $4095 \times$  slope of the line.

**Note 3:** Parameter guaranteed by design and characterization:  $T_A = T_{MIN}$  to  $T_{MAX}$ .

**Note 4:** PSRR is measured with both analog and digital supplies connected to the same potential.

# 1.8V, 12-Bit, 170Mps ADC for Broadband Applications

## Typical Operating Characteristics

( $V_{CC} = OV_{CC} = 1.8V$ ,  $AGND = OGND = 0$ ,  $f_{SAMPLE} = 170MHz$ ,  $A_{IN} = -1dBFS$ ; see each TOC for detailed information on test conditions, differential input drive, differential sine-wave clock input drive, 0.1 $\mu F$  capacitor on REFIO, internal reference, digital output pins differential  $R_L = 100\Omega$ ,  $T_A = +25^\circ C$ .)

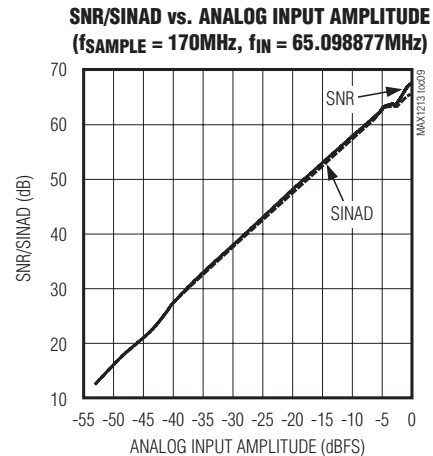
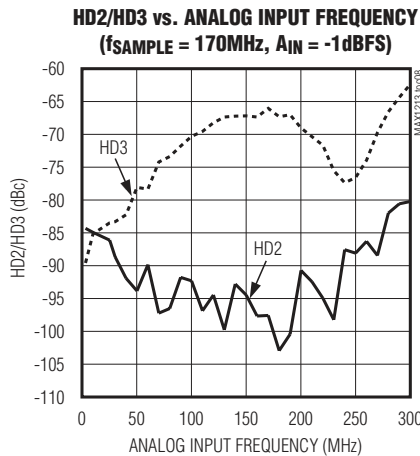
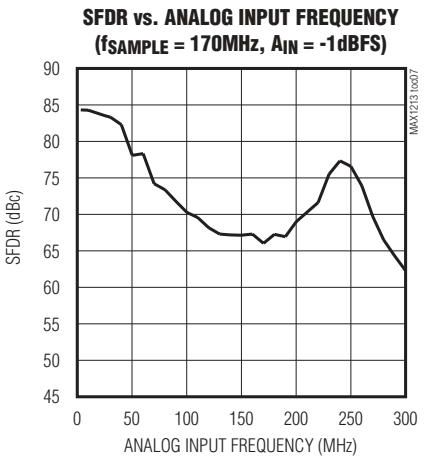
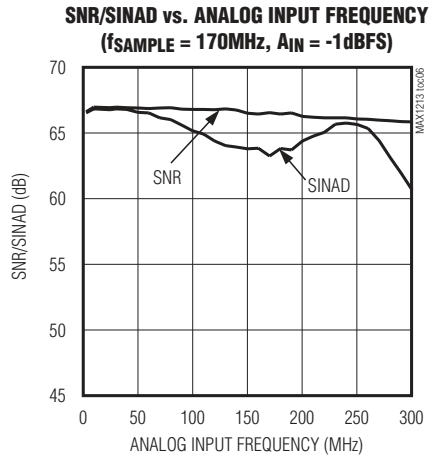
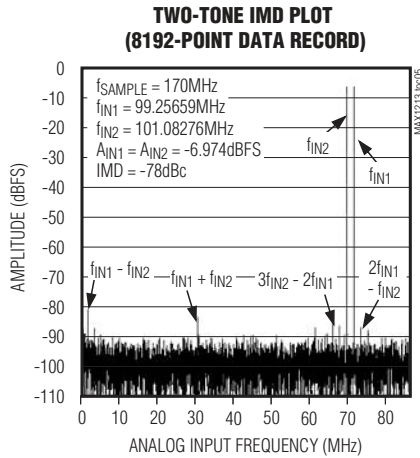
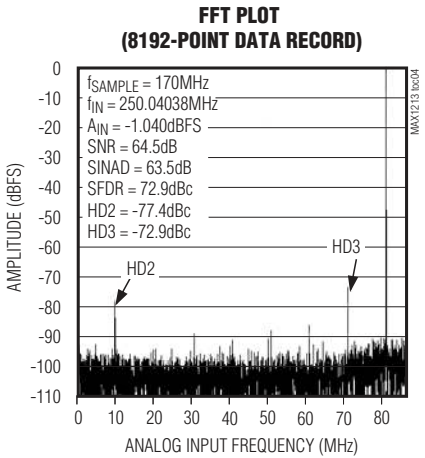
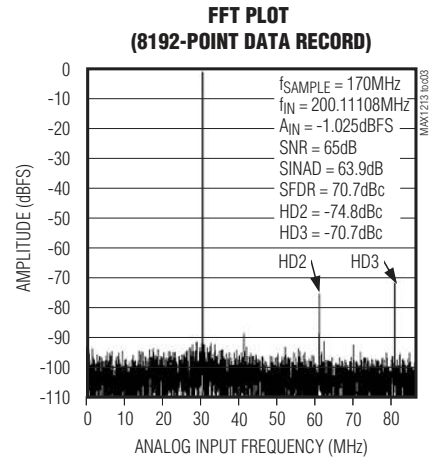
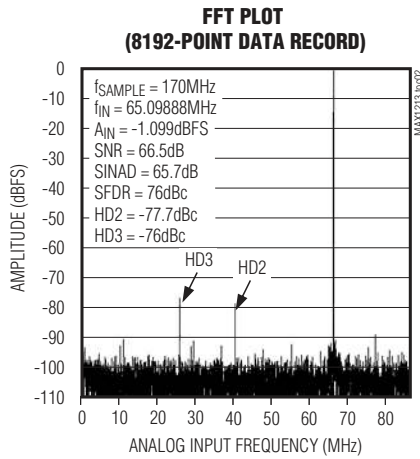
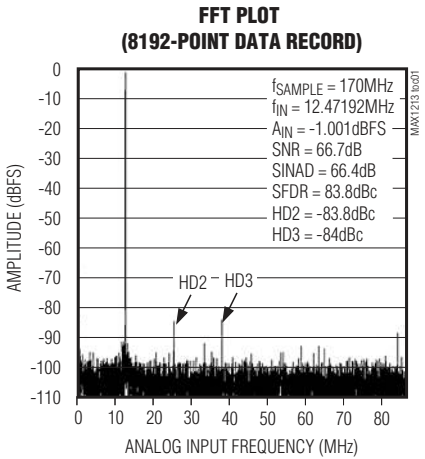

# 1.8V, 12-Bit, 170Mps ADC for Broadband Applications

## Typical Operating Characteristics (continued)

( $V_{CC} = OV_{CC} = 1.8V$ ,  $AGND = OGND = 0$ ,  $f_{SAMPLE} = 170MHz$ ,  $A_{IN} = -1dBFS$ ; see each TOC for detailed information on test conditions, differential input drive, differential sine-wave clock input drive, 0.1 $\mu F$  capacitor on REFIO, internal reference, digital output pins differential  $R_L = 100\Omega$ ,  $T_A = +25^\circ C$ .)

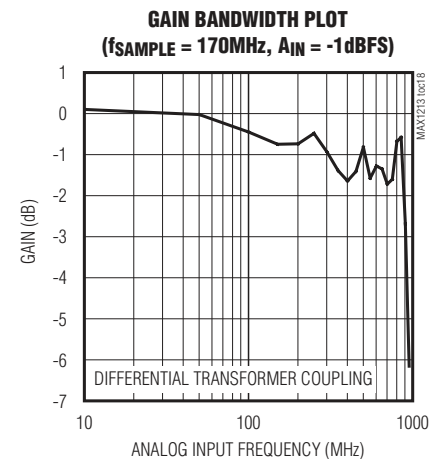
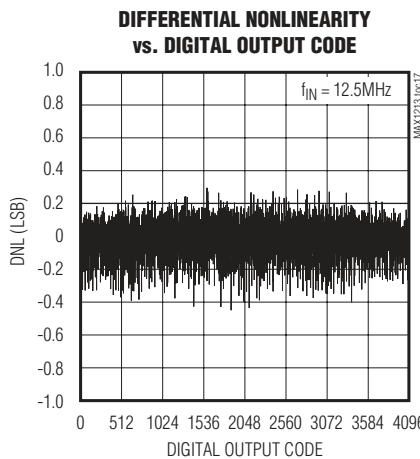
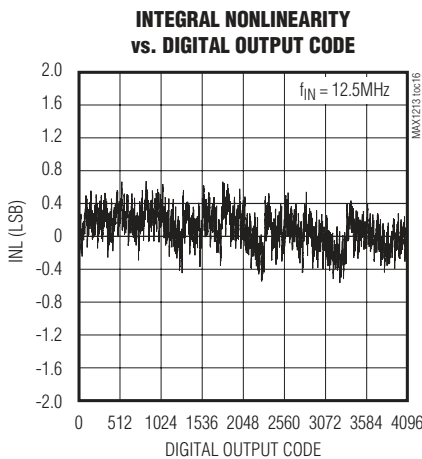
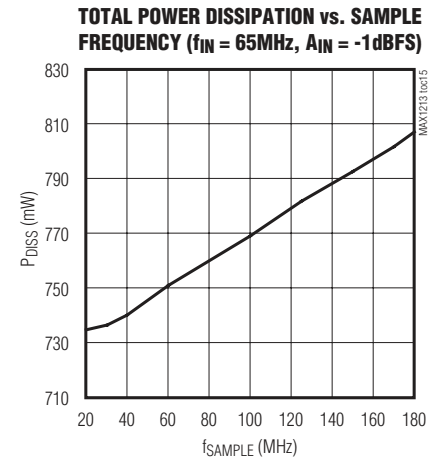
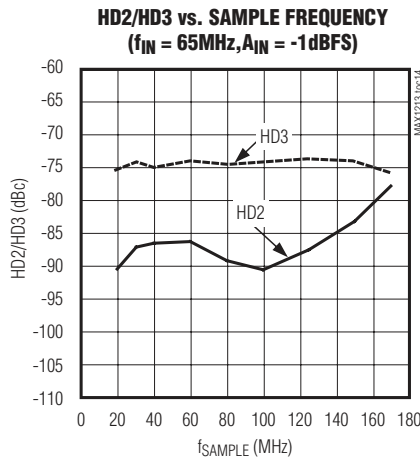
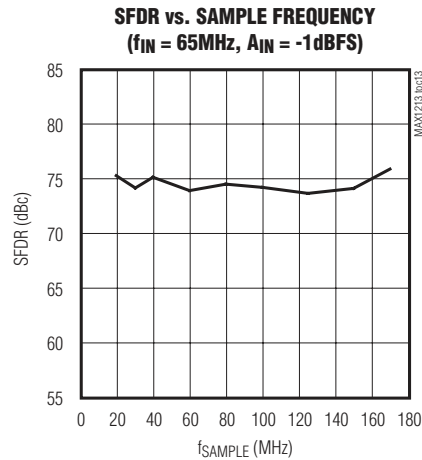
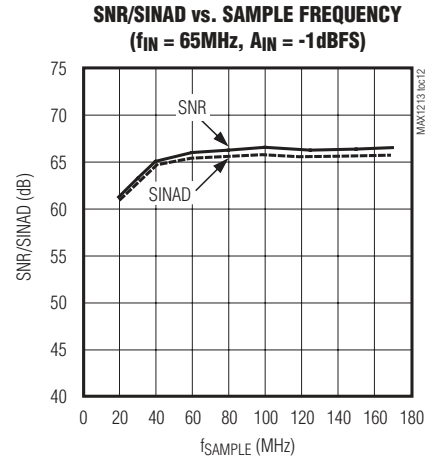
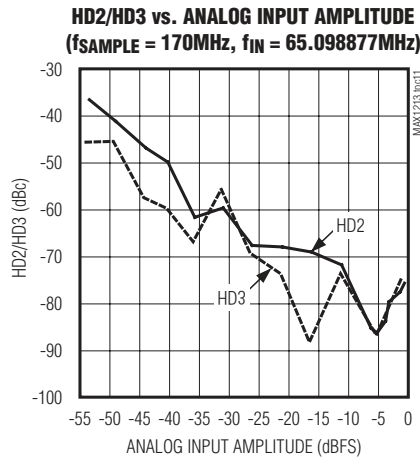
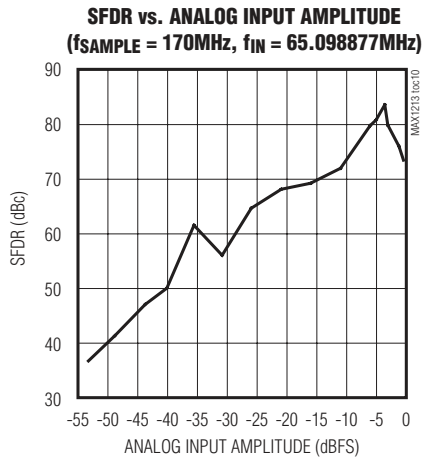

# 1.8V, 12-Bit, 170Mps ADC for Broadband Applications

## Typical Operating Characteristics (continued)

( $AV_{CC} = OV_{CC} = 1.8V$ ,  $AGND = OGND = 0$ ,  $f_{SAMPLE} = 170MHz$ ,  $A_{IN} = -1dBFS$ ; see each TOC for detailed information on test conditions, differential input drive, differential sine-wave clock input drive, 0.1 $\mu F$  capacitor on REFIO, internal reference, digital output pins differential  $R_L = 100\Omega$ ,  $T_A = +25^\circ C$ .)

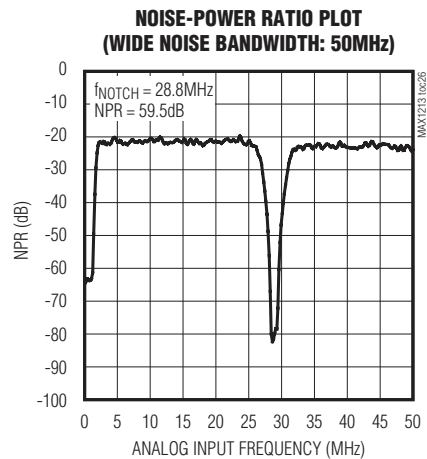
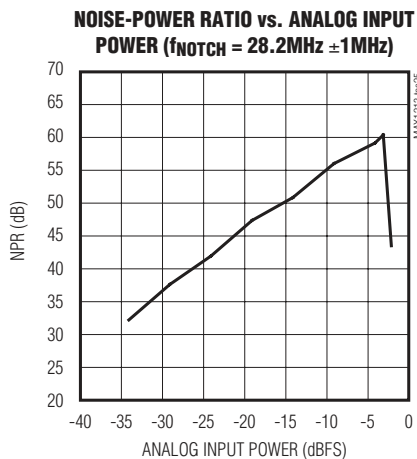
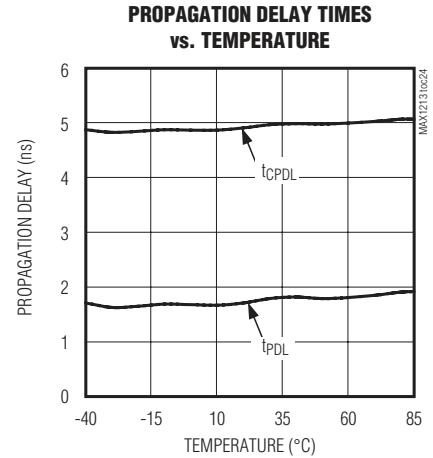
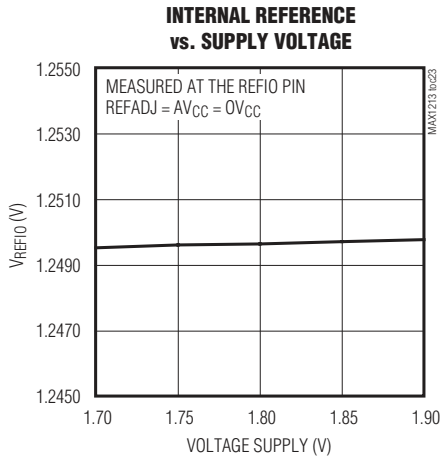
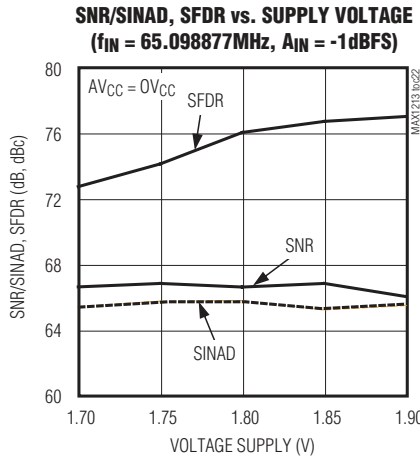
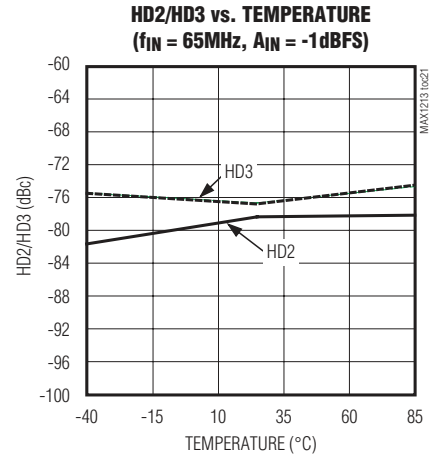
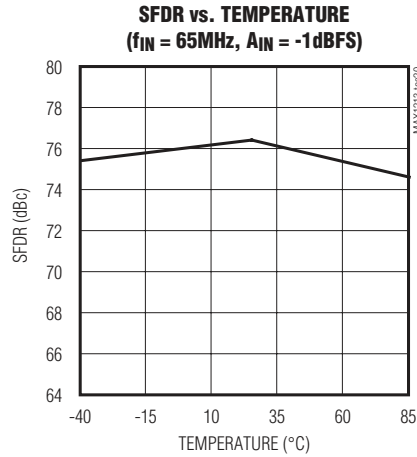
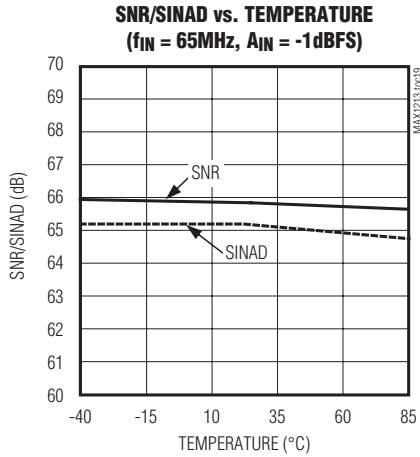

# 1.8V, 12-Bit, 170MSPS ADC for Broadband Applications

## Pin Description

PIN	NAME	FUNCTION
1, 6, 11–14, 20, 25, 62, 63, 65	AVCC	Analog Supply Voltage. Bypass each pin with a parallel combination of 0.1 $\mu$ F and 0.22 $\mu$ F capacitors for best decoupling results.
2, 5, 7, 10, 15, 16, 18, 19, 21, 24, 64, 66, 67	AGND	Analog Converter Ground
3	REFIO	Reference Input/Output. With REFADJ pulled high, this I/O port allows an external reference source to be connected to the MAX1213. With REFADJ pulled low, the internal 1.23V bandgap reference is active.
4	REFADJ	Reference Adjust Input. REFADJ allows for FSR adjustments by placing a resistor or trim potentiometer between REFADJ and AGND (decreases FSR) or REFADJ and REFIO (increases FSR). If REFADJ is connected to AVCC, the internal reference can be overdriven with an external source connected to REFIO. If REFADJ is connected to AGND, the internal reference is used to determine the FSR of the data converter.
8	INP	Positive Analog Input Terminal. Internally self-biased to 1.365V.
9	INN	Negative Analog Input Terminal. Internally self-biased to 1.365V.
17	CLKDIV	Clock Divider Input. This LVCMOS-compatible input controls which speed the converter's digital outputs are updated with. CLKDIV has an internal pulldown resistor. CLKDIV = 0: ADC updates digital outputs at one-half the input clock rate. CLKDIV = 1: ADC updates digital outputs at input clock rate.
22	CLKP	True Clock Input. This input ideally requires an LVPECL-compatible input level to maintain the converter's excellent performance. Internally self-biased to 1.15V.
23	CLKN	Complementary Clock Input. This input ideally requires an LVPECL-compatible input level to maintain the converter's excellent performance. Internally self-biased to 1.15V.
26, 45, 61	OGND	Digital Converter Ground. Ground connection for digital circuitry and output drivers.
27, 28, 41, 44, 60	OVCC	Digital Supply Voltage. Bypass with a 0.1 $\mu$ F capacitor for best decoupling results.
29	D0N	Complementary Output Bit 0 (LSB)
30	D0P	True Output Bit 0 (LSB)
31	D1N	Complementary Output Bit 1
32	D1P	True Output Bit 1
33	D2N	Complementary Output Bit 2
34	D2P	True Output Bit 2
35	D3N	Complementary Output Bit 3
36	D3P	True Output Bit 3



# 1.8V, 12-Bit, 170MSPS ADC for Broadband Applications

## Pin Description (continued)

MAX1213

PIN	NAME	FUNCTION
37	D4N	Complementary Output Bit 4
38	D4P	True Output Bit 4
39	D5N	Complementary Output Bit 5
40	D5P	True Output Bit 5
42	DCLKN	Complementary Clock Output. This output provides an LVDS-compatible output level and can be used to synchronize external devices to the converter clock.
43	DCLKP	True Clock Output. This output provides an LVDS-compatible output level and can be used to synchronize external devices to the converter clock.
46	D6N	Complementary Output Bit 6
47	D6P	True Output Bit 6
48	D7N	Complementary Output Bit 7
49	D7P	True Output Bit 7
50	D8N	Complementary Output Bit 8
51	D8P	True Output Bit 8
52	D9N	Complementary Output Bit 9
53	D9P	True Output Bit 9
54	D10N	Complementary Output Bit 10
55	D10P	True Output Bit 10
56	D11N	Complementary Output Bit 11 (MSB)
57	D11P	True Output Bit 11 (MSB)
58	ORN	Complementary Output for Out-of-Range Control Bit. If an out-of-range condition is detected, bit ORN flags this condition by transitioning low.
59	ORP	True Output for Out-of-Range Control Bit. If an out-of-range condition is detected, bit ORP flags this condition by transitioning high.
68	$\bar{T}/B$	Two's Complement or Binary Output Format Selection. This LVCMOS-compatible input controls the digital output format of the MAX1213. $\bar{T}/B$ has an internal pulldown resistor. $\bar{T}/B = 0$ : Two's complement output format. $\bar{T}/B = 1$ : Binary output format.
—	EP	Exposed Paddle. The exposed paddle is located on the backside of the chip and must be connected to analog ground for optimum performance.

# 1.8V, 12-Bit, 170Mps ADC for Broadband Applications

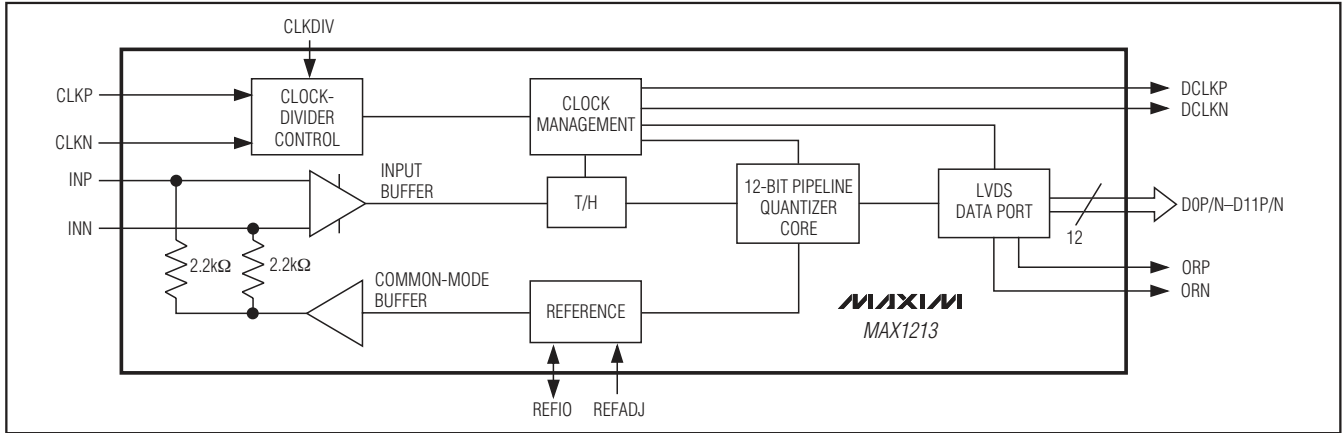

Figure 1. Simplified MAX1213 Block Diagram

## Detailed Description— Theory of Operation

The MAX1213 uses a fully differential pipelined architecture that allows for high-speed conversion, optimized accuracy, and linearity while minimizing power consumption and die size.

Both positive (INP) and negative/complementary analog input terminals (INN) are centered around a common-mode voltage of 1.365V, and accept a differential analog input voltage swing of  $\pm V_{FS} / 4$  each, resulting in a typical differential full-scale signal swing of 1.454V<sub>p-p</sub>. Inputs INP and INN are buffered prior to entering each T/H stage and are sampled when the differential sampling clock signal transitions high.

Each pipeline converter stage converts its input voltage to a digital output code. At every stage, except the last, the error between the input voltage and the digital output code is multiplied and passed along to the next pipeline stage. Digital error correction compensates for ADC comparator offsets in each pipeline stage and ensures no missing codes. The result is a 12-bit parallel digital output word in user-selectable two's complement or offset binary output formats with LVDS-compatible output levels. See Figure 1 for a more detailed view of the MAX1213 architecture.

### Analog Inputs (INP, INN)

INP and INN are the fully differential inputs of the MAX1213. Differential inputs usually feature good rejection of even-order harmonics, which allows for enhanced AC performance as the signals are progressing through the analog stages. The MAX1213 analog inputs are self-biased at a common-mode voltage of 1.365V and allow a differential input voltage swing of 1.454V<sub>p-p</sub> (Figure 2). Both inputs are self-biased

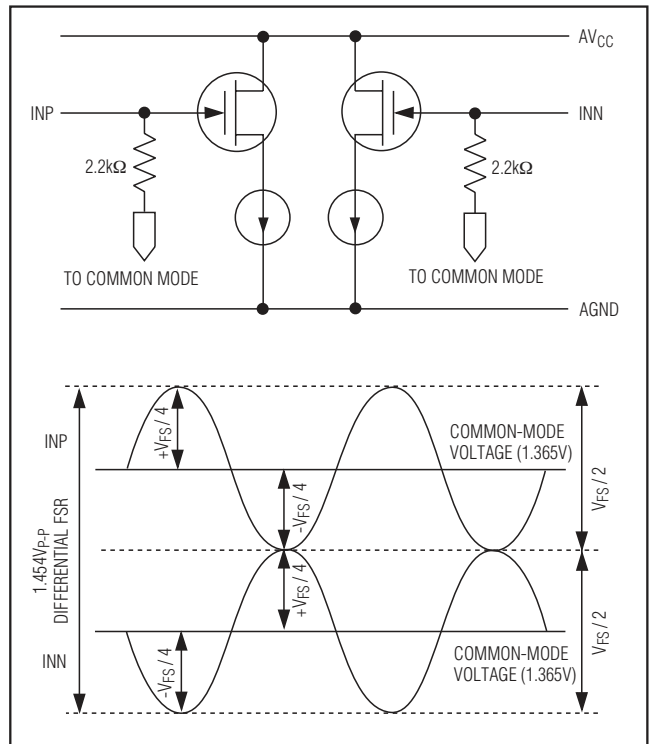

Figure 2. Simplified Analog Input Architecture and Allowable Input Voltage Range

through 2kΩ resistors, resulting in a typical differential input resistance of 4kΩ. It is recommended to drive the analog inputs of the MAX1213 in AC-coupled configuration to achieve best dynamic performance. See the *Transformer-Coupled, Differential Analog Input Drive* section for a detailed discussion of this configuration.

# 1.8V, 12-Bit, 170MSPS ADC for Broadband Applications

## On-Chip Reference Circuit

The MAX1213 features an internal 1.23V bandgap reference circuit (Figure 3), which in combination with an internal reference-scaling amplifier determines the FSR of the MAX1213. Bypass REFIO with a 0.1 $\mu$ F capacitor to AGND. To compensate for gain errors or increase the ADC's FSR, the voltage of this bandgap reference can be indirectly adjusted by adding an external resistor (e.g., 100k $\Omega$  trim potentiometer) between REFADJ and AGND or REFADJ and REFIO. See the *Applications Information* section for a detailed description of this process.

To disable the internal reference, connect REFADJ to AV<sub>CC</sub>. In this configuration, an external, stable reference must be applied to REFIO to set the converter's full scale. To enable the internal reference, connect REFADJ to AGND.

## Clock Inputs (CLKP, CLKN)

Designed for a differential LVDS clock input drive, it is recommended to drive the clock inputs of the MAX1213 with an LVDS- or LVPECL-compatible clock to achieve the best dynamic performance. The clock signal source must be a high-quality, low-phase noise with fast edge rates to avoid any degradation in the noise performance of the ADC. The clock inputs (CLKP, CLKN) are internally biased to 1.15V, accept a typical differential signal swing of 0.5V<sub>p-p</sub>, and are usually driven in AC-coupled configuration. See the *Differential, AC-Coupled, LVPECL-Compatible Clock Input* section for more circuit details on how to drive CLKP and CLKN appropriately. Although not recommended, the clock inputs also accept a single-ended input signal.

The MAX1213 also features an internal clock-management circuit (duty-cycle equalizer) that ensures that the clock signal applied to inputs CLKP and CLKN is processed to provide a 50% duty-cycle clock signal that desensitizes the performance of the converter to variations in the duty cycle of the input clock source. Note that the clock duty-cycle equalizer cannot be turned off externally and requires a minimum clock frequency of > 20MHz to work appropriately and according to data sheet specifications.

## Data Clock Outputs (DCLKP, DCLKN)

The MAX1213 features a differential clock output, which can be used to latch the digital output data with an external latch or receiver. Additionally, the clock output can be used to synchronize external devices (e.g., FPGAs) to the ADC. DCLKP and DCLKN are differential outputs with LVDS-compatible voltage levels. There is a 4.95ns delay time between the rising (falling) edge of CLKP (CLKN) and the rising edge of DCLKP (DCLKN). See Figure 4 for timing details.

## Divide-by-2 Clock Control (CLKDIV)

The MAX1213 offers a clock control line (CLKDIV), which supports the reduction of clock jitter in a system. Connect CLKDIV to OGND to enable the ADC's internal divide-by-2 clock divider. Data is now updated at one-half the ADC's input clock rate. CLKDIV has an internal pull-down resistor and can be left open for applications that require this divide-by-2 mode. Connecting CLKDIV to OV<sub>CC</sub> disables the divide-by-2 mode.

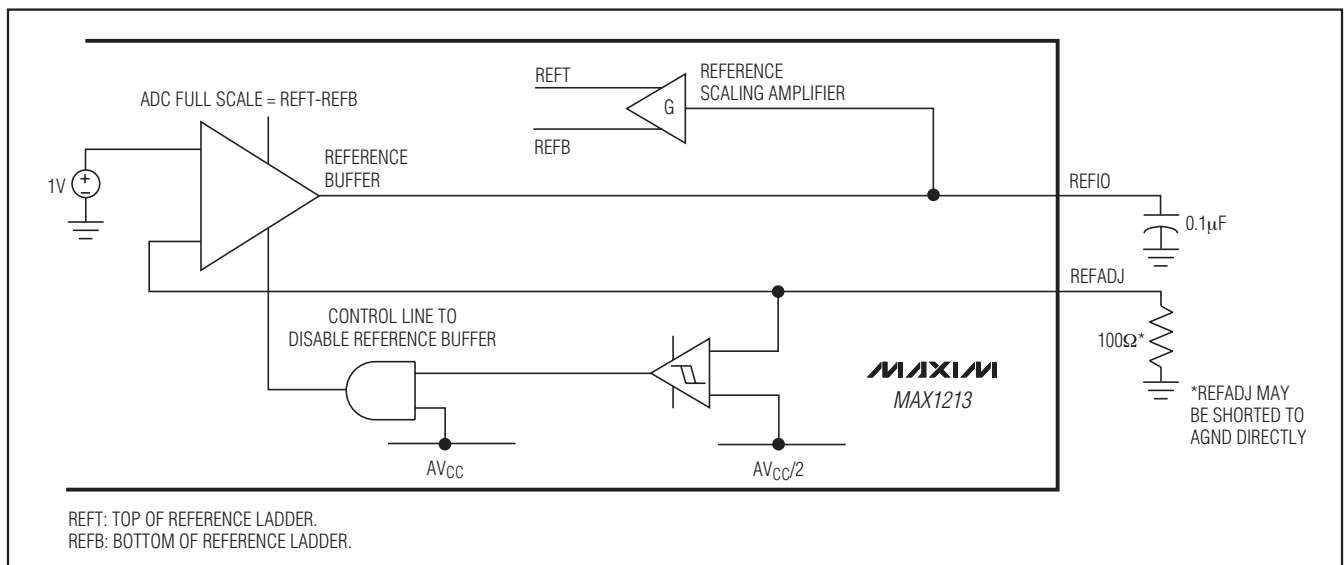

Figure 3. Simplified Reference Architecture

# 1.8V, 12-Bit, 170Mps ADC for Broadband Applications

## System Timing Requirements

Figure 4 depicts the relationship between the clock input and output, analog input, sampling event, and data output. The MAX1213 samples on the rising (falling) edge of CLKP (CLKN). Output data is valid on the next rising (falling) edge of the DCLKP (DCLKN) clock, but has an internal latency of 11 clock cycles.

## Digital Outputs (D0P/N–D11P/N, DCLKP/N, ORP/N) and Control Input $\bar{T}/B$

Digital outputs D0P/N–D11P/N, DCLKP/N, and ORP/N are LVDS compatible, and data on D0P/N–D11P/N is presented in either binary or two’s-complement format (Table 1). The  $\bar{T}/B$  control line is an LVCMOS-compatible input, which allows the user to select the desired output format. Pulling  $\bar{T}/B$  low outputs data in two’s complement and pulling it high presents data in offset binary format on the 12-bit parallel bus.  $\bar{T}/B$  has an internal pulldown resistor and may be left unconnected in applications using only two’s complement output for-

mat. All LVDS outputs provide a typical voltage swing of 0.325V around a common-mode voltage of roughly 1.15V, and must be differentially terminated at the far end of each transmission line pair (true and complementary) with 100Ω. The LVDS outputs are powered from a separate power supply, which can be operated between 1.7V and 1.9V.

The MAX1213 offers an additional differential output pair (ORP, ORN) to flag out-of-range conditions, where out-of-range is above positive or below negative full scale. An out-of-range condition is identified with ORP (ORN) transitioning high (low).

**Note:** Although a differential LVDS output architecture reduces single-ended transients to the supply and ground planes, capacitive loading on the digital outputs should still be kept as low as possible. Using LVDS buffers on the digital outputs of the ADC when driving larger loads may improve overall performance and reduce system-timing constraints.

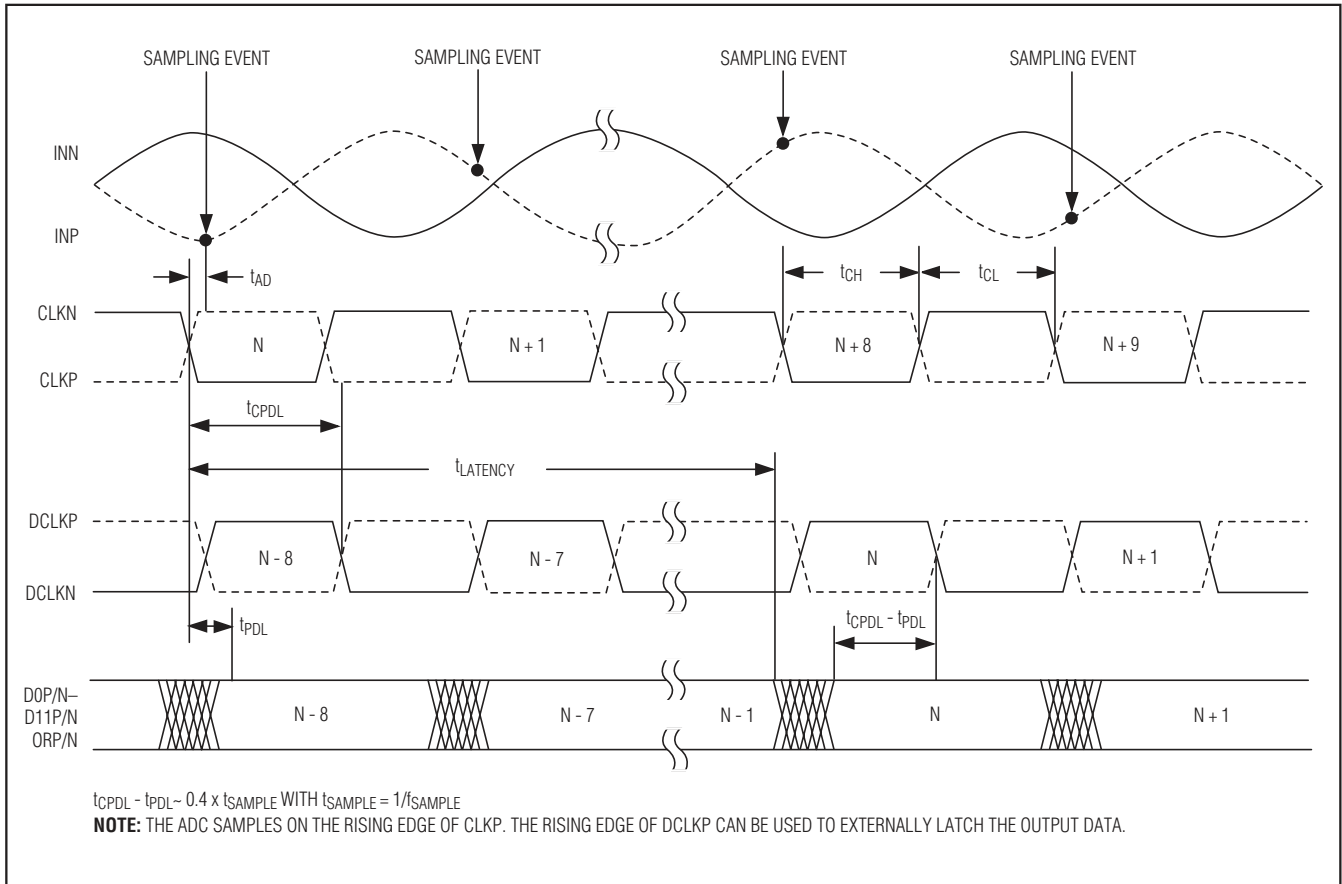

Figure 4. System and Output Timing Diagram

# 1.8V, 12-Bit, 170Mps ADC for Broadband Applications

**Table 1. MAX1213 Digital Output Coding**

INP ANALOG INPUT VOLTAGE LEVEL	INN ANALOG INPUT VOLTAGE LEVEL	OUT-OF-RANGE ORP (ORN)	BINARY DIGITAL OUTPUT CODE (D11P/N-D0P/N)	TWO'S COMPLEMENT DIGITAL OUTPUT CODE (D11P/N-D0P/N)
$> V_{CM} + V_{FS} / 4$	$< V_{CM} - V_{FS} / 4$	1 (0)	1111 1111 1111 (exceeds +FS, OR set)	0111 1111 1111 (exceeds +FS, OR set)
$V_{CM} + V_{FS} / 4$	$V_{CM} - V_{FS} / 4$	0 (1)	1111 1111 1111 (+FS)	0111 1111 1111 (+FS)
$V_{CM}$	$V_{CM}$	0 (1)	1000 0000 0000 or 0111 1111 1111 (FS/2)	0000 0000 0000 or 1111 1111 1111 (FS/2)
$V_{CM} - V_{FS} / 4$	$V_{CM} + V_{FS} / 4$	0 (1)	0000 0000 0000 (-FS)	1000 0000 0000 (-FS)
$< V_{CM} + V_{FS} / 4$	$> V_{CM} - V_{FS} / 4$	1 (0)	00 0000 0000 (exceeds -FS, OR set)	10 0000 0000 (exceeds -FS, OR set)

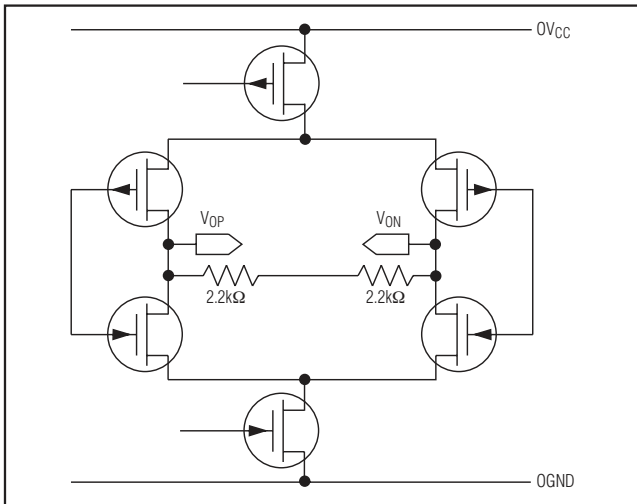

Figure 5. Simplified LVDS Output Architecture

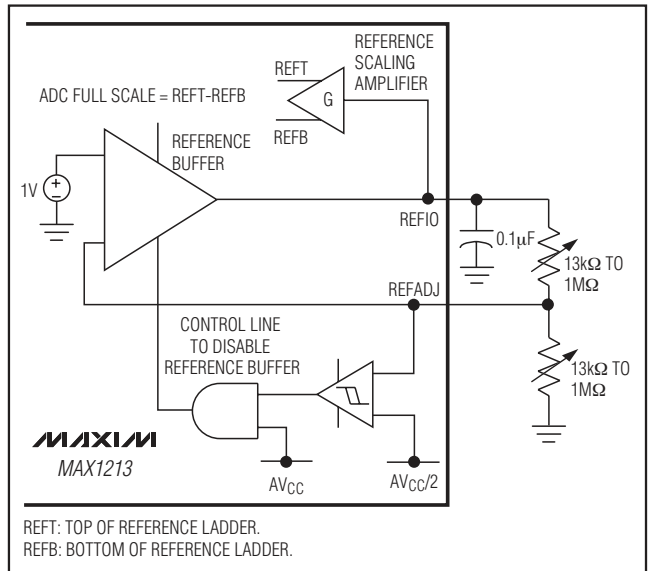

Figure 6a: Circuit Suggestions to Adjust the ADC's Full-Scale Range

## Applications Information

### FSR Adjustments Using the Internal Bandgap Reference

The MAX1213 supports a full-scale adjustment range of 10% ( $\pm 5\%$ ). To decrease the full-scale signal range, an external resistor value ranging from 13k $\Omega$  to 1M $\Omega$  may be added between REFADJ and AGND. A similar approach can be taken to increase the ADC's full-scale range (FSR). Adding a variable resistor, potentiometer, or predetermined resistor value between REFADJ and REFIO increases the FSR of the data converter. Figure 6a shows the two possible configurations and their impact on the overall full-scale range adjustment of the MAX1213. Do not use resistor values of less than 13k $\Omega$  to avoid instability of the internal gain regulation loop for the bandgap reference. See Figure 6b for the results of the adjustment range for a selection of resistors used to trim the full-scale range of the MAX1213.

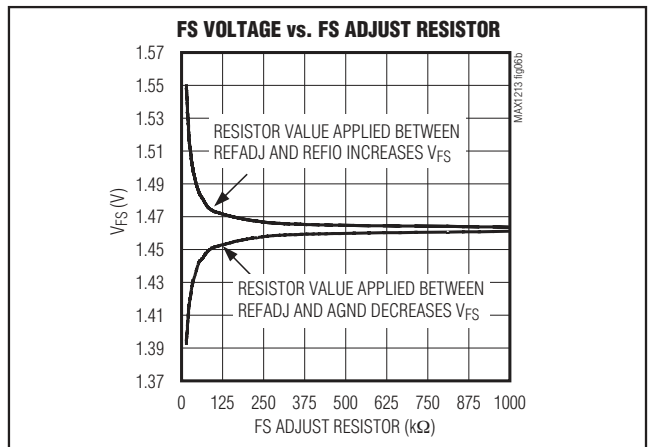

Figure 6b: FS Adjustment Range vs. FS Adjustment Resistor

# 1.8V, 12-Bit, 170Mps ADC for Broadband Applications

## Differential, AC-Coupled, LVPECL-Compatible Clock Input

The MAX1213 dynamic performance depends on the use of a very clean clock source. The phase noise floor of the clock source has a negative impact on the SNR performance. Spurious signals on the clock signal source also affect the ADC's dynamic range. The preferred method of clocking the MAX1213 is differentially with LVDS- or LVPECL-compatible input levels. The fast data transition rates of these logic families minimize the clock-input circuitry's transition uncertainty, thereby improving the SNR performance. To accomplish this, a  $50\Omega$  reverse-terminated clock signal source with low phase noise is AC-coupled into a fast differential receiver such as the MC100LVEL16D (Figure 7). The receiver produces the necessary LVPECL output levels to drive the clock inputs of the data converter.

## Transformer-Coupled, Differential Analog Input Drive

In general, the MAX1213 provides the best SFDR and THD with fully differential input signals and it is not re-

commended to drive the ADC inputs in single-ended configuration. In differential input mode, even-order harmonics are usually lower since INP and INN are balanced, and each of the ADC inputs only requires half the signal swing compared to a single-ended configuration. Wideband RF transformers provide an excellent solution to convert a single-ended signal to a fully differential signal, required by the MAX1213 to reach its optimum dynamic performance.

A secondary-side termination of a 1:1 transformer (e.g., Mini-Circuit's ADT1-1WT) into two separate  $24.9\Omega \pm 1\%$  resistors (use tight resistor tolerances to minimize effects of imbalance; 0.5% would be an ideal choice) placed between top/bottom and center tap of the transformer is recommended to maximize the ADC's dynamic range. This configuration optimizes THD and SFDR performance of the ADC by reducing the effects of transformer parasitics. However, the source impedance combined with the shunt capacitance provided by a PC board and the ADC's parasitic capacitance limit the ADC's full-power input bandwidth to approximately 600MHz.

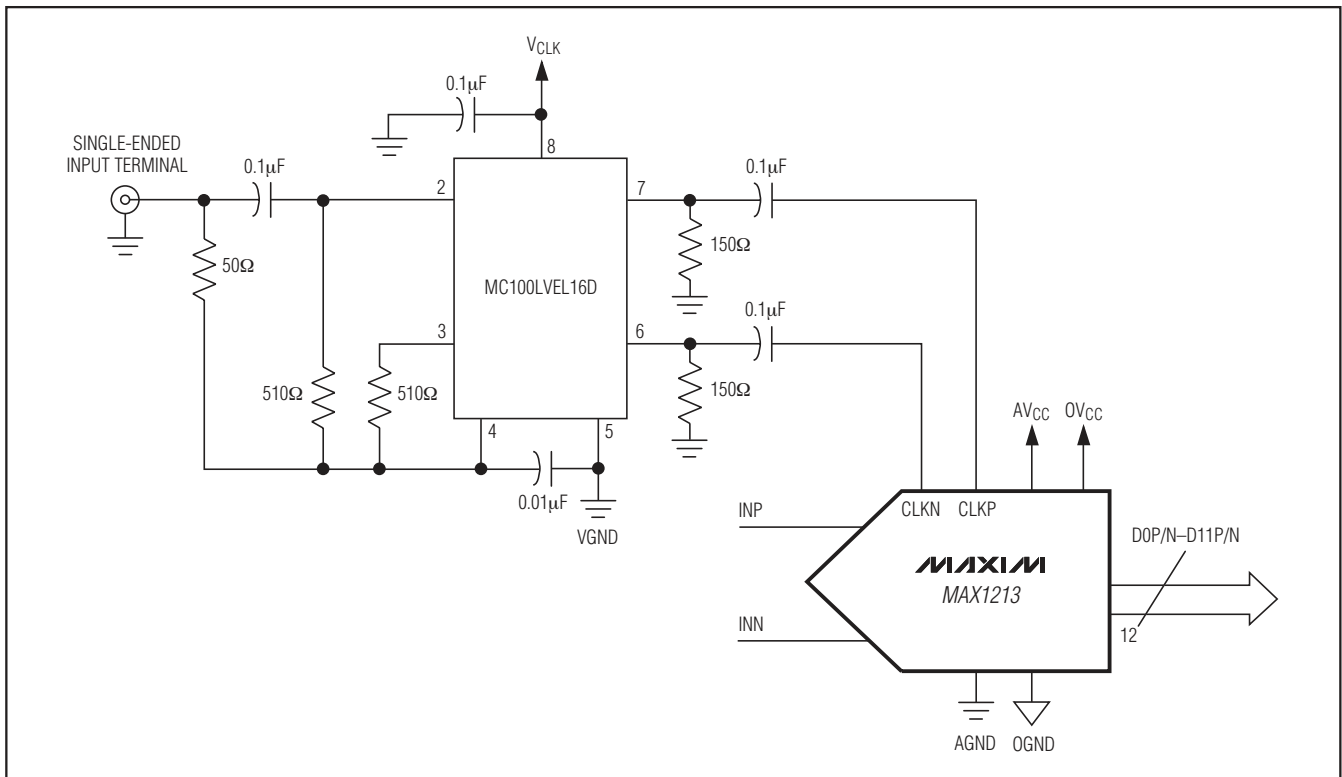

Figure 7. Differential, AC-Coupled, LVPECL-Compatible Clock Input Configuration

# 1.8V, 12-Bit, 170MSPS ADC for Broadband Applications

To further enhance THD and SFDR performance at high-input frequencies (>100MHz), a second transformer (Figure 8) should be placed in series with the single-ended-to-differential conversion transformer. This transformer reduces the increase of even-order harmonics at high frequencies.

### Single-Ended, AC-Coupled Analog Inputs

Although not recommended, the MAX1213 can be used in single-ended mode (Figure 9). Analog signals can be AC-coupled to the positive input INP through a 0.1µF capacitor and terminated with a 49.9Ω resistor to AGND. The negative input should be reverse terminated with 49.9Ω resistors and AC-grounded with a 0.1µF capacitor.

### Grounding, Bypassing, and Board Layout Considerations

The MAX1213 requires board layout design techniques suitable for high-speed data converters. This ADC provides separate analog and digital power supplies. The analog and digital supply voltage pins accept input voltage ranges of 1.7V to 1.9V. Although both supply types can be combined and supplied from one source, it is recommended to use separate sources to cut down on performance degradation caused by digital switching currents, which can couple into the analog supply network. Isolate analog and digital supplies (AVCC and OVCC) where they enter the PC board with separate networks of ferrite beads and capacitors to their corresponding grounds (AGND, OGND).

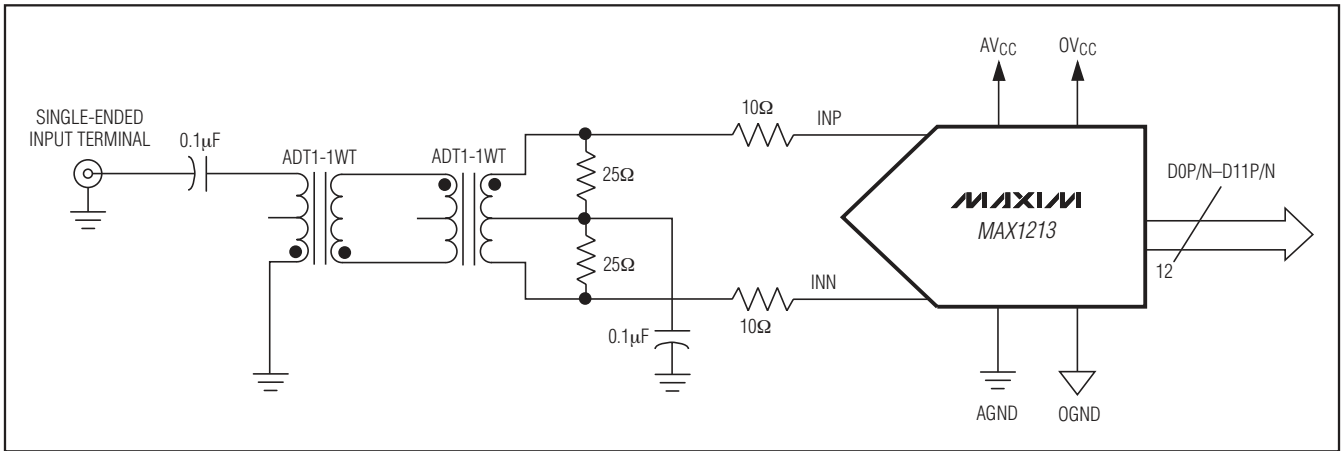

Figure 8. Analog Input Configuration with Back-to-Back Transformers and Secondary-Side Termination

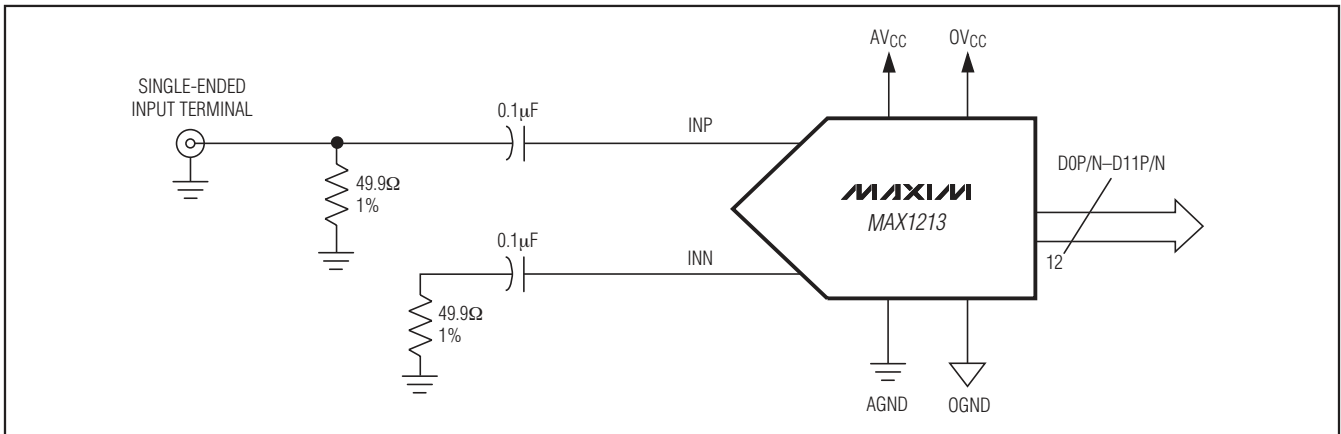

Figure 9. Single-Ended AC-Coupled Analog Input Configuration



# 1.8V, 12-Bit, 170Mps ADC for Broadband Applications

To achieve optimum performance, provide each supply with a separate network of a 47 $\mu$ F tantalum capacitor and parallel combinations of 10 $\mu$ F and 1 $\mu$ F ceramic capacitors. Additionally, the ADC requires each supply pin to be bypassed with separate 0.1 $\mu$ F ceramic capacitors (Figure 10). Locate these capacitors directly at the ADC supply pins or as close as possible to the MAX1213. Choose surface-mount capacitors, whose preferred location should be on the same side as the converter to save space and minimize the inductance. If close placement on the same side is not possible, these bypassing capacitors may be routed through vias to the bottom side of the PC board.

Multilayer boards with separated ground and power planes produce the highest level of signal integrity. Consider the use of a split ground plane arranged to match the physical location of analog and digital ground on the ADC's package. The two ground planes should be joined at a single point such that the noisy digital ground currents do not interfere with the analog ground plane. The dynamic currents that may need to travel long distances before they are recombined at a common-source ground, resulting in large and undesirable ground loops, are a major concern with this approach. Ground loops can degrade the input noise by coupling back to the analog front end of the converter, resulting in increased spurious activity, leading to decreased noise performance.

Alternatively, all ground pins could share the same ground plane, if the ground plane is sufficiently isolated from any noisy, digital systems ground. To minimize the coupling of the digital output signals from the analog

input, segregate the digital output bus carefully from the analog input circuitry. To further minimize the effects of digital noise coupling, ground return vias can be positioned throughout the layout to divert digital switching currents away from the sensitive analog sections of the ADC. This approach does not require split ground planes, but can be accomplished by placing substantial ground connections between the analog front end and the digital outputs.

The MAX1213 is packaged in a 68-pin QFN-EP package (**package code: G6800-4**), providing greater design flexibility, increased thermal dissipation, and optimized AC performance of the ADC. The exposed paddle (EP) must be soldered down to AGND.

In this package, the data converter die is attached to an EP lead frame with the back of this frame exposed at the package bottom surface, facing the PC board side of the package. This allows a solid attachment of the package to the board with standard infrared (IR) flow soldering techniques.

Thermal efficiency is one of the factors for selecting a package with an exposed pad for the MAX1213. The exposed pad improves thermal and ensures a solid ground connection between the DAC and the PC board's analog ground layer.

Considerable care must be taken when routing the digital output traces for a high-speed, high-resolution data converter. It is recommended running the LVDS output traces as differential lines with 100 $\Omega$  matched impedance from the ADC to the LVDS load device.

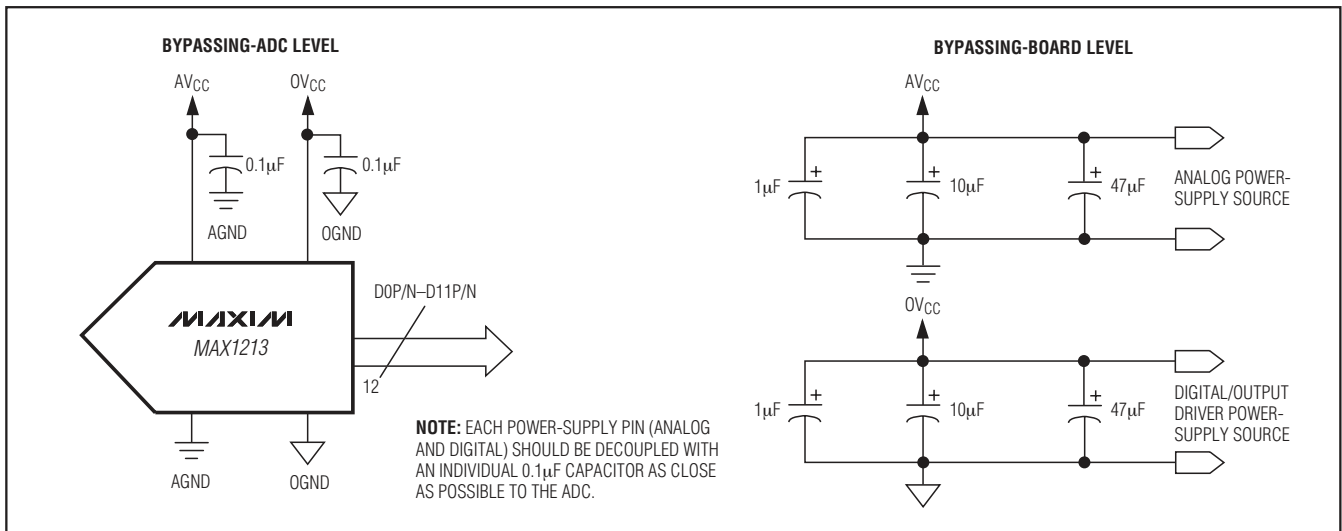

Figure 10. Grounding, Bypassing, and Decoupling Recommendations for MAX1213



# 1.8V, 12-Bit, 170MSPS ADC for Broadband Applications

## Static Parameter Definitions

### Integral Nonlinearity (INL)

Integral nonlinearity is the deviation of the values on an actual transfer function from a straight line. This straight line can be either a best straight-line fit or a line drawn between the end points of the transfer function, once offset and gain errors have been nullified. However, the static linearity parameters for the MAX1213 are measured using the histogram method with an input frequency of 10MHz.

### Differential Nonlinearity (DNL)

Differential nonlinearity is the difference between an actual step width and the ideal value of 1LSB. A DNL error specification of less than 1LSB guarantees no missing codes and a monotonic transfer function. The MAX1213's DNL specification is measured with the histogram method based on a 10MHz input tone.

## Dynamic Parameter Definitions

### Aperture Jitter

Figure 11 depicts the aperture jitter ( $t_{AJ}$ ), which is the sample-to-sample variation in the aperture delay.

### Aperture Delay

Aperture delay ( $t_{AD}$ ) is the time defined between the rising edge of the sampling clock and the instant when an actual sample is taken (Figure 11).

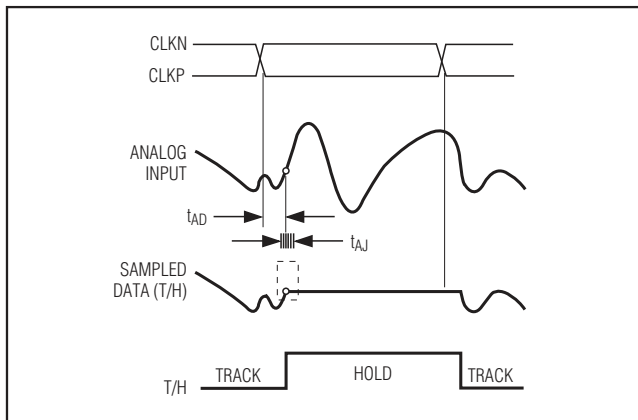

Figure 11. Aperture Jitter/Delay Specifications

### Signal-to-Noise Ratio (SNR)

For a waveform perfectly reconstructed from digital samples, the theoretical maximum SNR is the ratio of the full-scale analog input (RMS value) to the RMS quantization error (residual error). The ideal, theoretical minimum analog-to-digital noise is caused by quantiza-

tion error only and results directly from the ADC's resolution (N bits):

$$SNR_{[max]} = 6.02 \times N + 1.76$$

In reality, other noise sources such as thermal noise, clock jitter, signal phase noise, and transfer function nonlinearities are also contributing to the SNR calculation and should be considered when determining the signal-to-noise ratio in ADC.

### Signal-to-Noise Plus Distortion (SINAD)

SINAD is computed by taking the ratio of the RMS signal to all spectral components excluding the fundamental and the DC offset. In the case of the MAX1213, SINAD is computed from a curve fit.

### Spurious-Free Dynamic Range (SFDR)

SFDR is the ratio of RMS amplitude of the carrier frequency (maximum signal component) to the RMS value of the next-largest noise or harmonic distortion component. SFDR is usually measured in dBc with respect to the carrier frequency amplitude or in dBFS with respect to the ADC's full-scale range.

### Intermodulation Distortion (IMD)

IMD is the ratio of the RMS sum of the intermodulation products to the RMS sum of the two fundamental input tones. This is expressed as:

$$IMD = 20 \times \log \left( \frac{\sqrt{V_{IM1}^2 + V_{IM2}^2 + \dots + V_{IM3}^2 + V_{IMn}^2}}{\sqrt{V_1^2 + V_2^2}} \right)$$

The fundamental input tone amplitudes ( $V_1$  and  $V_2$ ) are at -7dBFS. The intermodulation products are the amplitudes of the output spectrum at the following frequencies:

- Second-order intermodulation products:  $f_{IN1} + f_{IN2}$ ,  $f_{IN2} - f_{IN1}$
- Third-order intermodulation products:  $2 \times f_{IN1} - f_{IN2}$ ,  $2 \times f_{IN2} - f_{IN1}$ ,  $2 \times f_{IN1} + f_{IN2}$ ,  $2 \times f_{IN2} + f_{IN1}$
- Fourth-order intermodulation products:  $3 \times f_{IN1} - f_{IN2}$ ,  $3 \times f_{IN2} - f_{IN1}$ ,  $3 \times f_{IN1} + f_{IN2}$ ,  $3 \times f_{IN2} + f_{IN1}$
- Fifth-order intermodulation products:  $3 \times f_{IN1} - 2 \times f_{IN2}$ ,  $3 \times f_{IN2} - 2 \times f_{IN1}$ ,  $3 \times f_{IN1} + 2 \times f_{IN2}$ ,  $3 \times f_{IN2} + 2 \times f_{IN1}$

### Full-Power Bandwidth

A large -1dBFS analog input signal is applied to an ADC and the input frequency is swept up to the point where the amplitude of the digitized conversion result has decreased by 3dB. The -3dB-point is defined as full-power input bandwidth frequency of the ADC.

# 1.8V, 12-Bit, 170Mps ADC for Broadband Applications

## Noise Power Ratio (NPR)

NPR is commonly used to characterize the return path of cable systems where the signals are typically individual quadrature amplitude-modulated (QAM) carriers with a frequency spectrum similar to noise. Numerous such carriers are operated in a continuous spectrum, generating a noise-like signal, which covers a relatively broad bandwidth. To test the MAX1213 for NPR, a “noise-like” signal is passed through a high-order bandpass filter to produce an approximately square spectral pedestal of noise with about the same bandwidth as the signals being simulated. Following the bandpass filter, the signal is passed through a narrow band-reject filter to produce a deep notch at the center of the noise pedestal. Finally, this signal is applied to the MAX1213 and its digitized results analyzed. The RMS noise power of the signal inside the notch is compared with the RMS noise level outside the notch using an FFT. Note that the NPR test requires sufficiently long data records to guarantee a suitable number of samples inside the notch. NPR for the MAX1213 was determined for 50MHz noise bandwidth signals, simulating a typical cable signal environment (see the *Typical Operating Characteristics* for test details and results) with a notch frequency of 28.8MHz.

## Pin-Compatible Lower Speed/Resolution Versions

Applications that require lower resolution, a choice of buffered or nonbuffered inputs, and/or higher speed can refer to other family members of the MAX1213. Adjusting an application to a lower resolution has been simplified by maintaining an identical pinout for all members of this high-speed family. See the *Pin-Compatible Versions* table for a selection of different resolution and speed grades.

## Pin Configuration

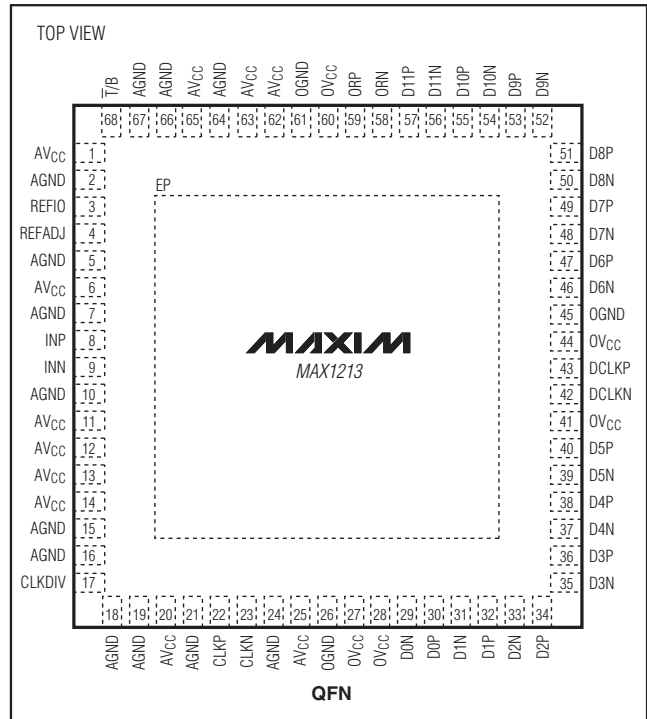

## Package Information

For the latest package outline information and land patterns, go to [www.maxim-ic.com/packages](http://www.maxim-ic.com/packages). Note that a “+”, “#”, or “-” in the package code indicates RoHS status only. Package drawings may show a different suffix character, but the drawing pertains to the package regardless of RoHS status.

PACKAGE TYPE	PACKAGE CODE	DOCUMENT NO.
68 QFN-EP	G6800-4	<a href="#">21-0122</a>

# 1.8V, 12-Bit, 170Msps ADC for Broadband Applications

## Revision History

REVISION NUMBER	REVISION DATE	DESCRIPTION	PAGES CHANGED
4	9/09	Updated TOCs 6, 7, and 8 and <i>Electrical Characteristics</i> to match FT/EC	1, 3, 5

MAX1213

Maxim cannot assume responsibility for use of any circuitry other than circuitry entirely embodied in a Maxim product. No circuit patent licenses are implied. Maxim reserves the right to change the circuitry and specifications without notice at any time.

Maxim Integrated Products, 120 San Gabriel Drive, Sunnyvale, CA 94086 408-737-7600 \_\_\_\_\_ 19