



RFM Integrated Device, Inc.

PRODUCT SPECIFICATION

Part Number: XO6004

XO,311.04M, +/-20 ppm
max, -30°C to +85°C

SMD 7.0x5.0 311.04 MHz Crystal Oscillator



Features:

- Surface Mount Seam Weld Package
- Excellent Reliability Performance
- Good Frequency Perturbation and Stability over temperature

Application:

- 3.3 V Supply Voltage LVPECL Output
- Option-able stand-by function for output .

Electrical Characteristics:

XO6004	Specifications
Nominal Frequency, Fo	311.0400 MHz
Storage Temperature Range	-55°C to +105°C
Operating Temperature Range	-30°C to +85°C
Power Supply Voltage, Vcc	3.3V +/- 5%
Load	50 ohm (LVPECL)
“0” Level “1” Level	1.45~1.7V 2.27~2.7 V
Power Supply Current, Icc	50 mA max
Frequency Tolerance	+/-20 ppm max
Duty Cycle	45% ~ 55%
Integrated Jitter Phase (12K~20MHz)	0.6 ps max
Rise Time (20% -> 80% of final RF level in Vp-p) Fall Time (80% -> 20% of final RF level in Vp-p)	0.5 nsec max. 0.5 nsec max.
Enable/Disable Function	PIN 1: 0.7 VDD or Open, Output Enable PIN 1: 0.3 VDD, Output Disable

#Note 1: Frequency accuracy includes 25C tolerance, operating temperature range -30 to 85deg C, aging and voltage or load change

Mechanical Dimensions: (Unit: mm)

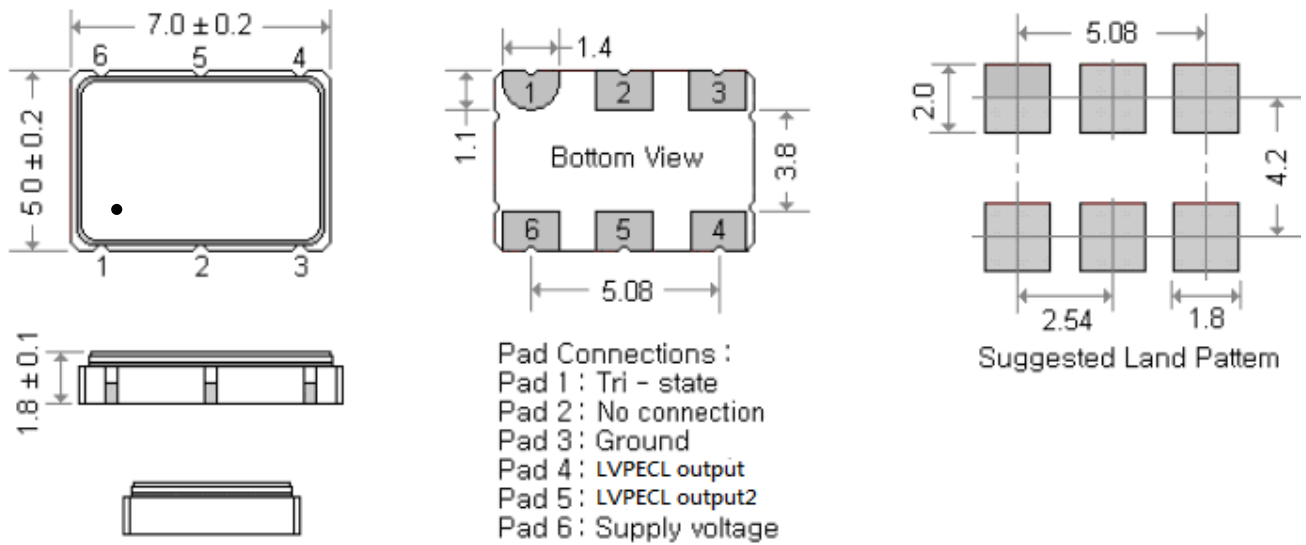

Marking :

Line 1 : Frequency (311.040)

Line 2 : $\text{\textcircled{T}}$ WDXX (Product Code + Date Code + Internal Traceability Code (XX) : Can be 1 or 2 letters)

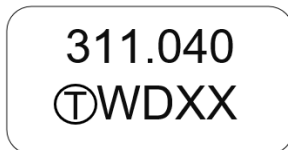

Product Code Table

Year	2013	2014	2015	2016
	2017	2018	2019	2020
	2021	2022	2023	2024
Product code	W	w	<u>W</u>	<u>w</u>

Date Code Table

Date Code Table												
WK01	WK02	WK03	WK04	WK05	WK06	WK07	WK08	WK09	WK10	WK11	WK12	WK13
A	B	C	D	E	F	G	H	I	J	K	L	M
WK14	WK15	WK16	WK17	WK18	WK19	WK20	WK21	WK22	WK23	WK24	WK25	WK26
N	O	P	Q	R	S	T	U	V	W	X	Y	Z
WK27	WK28	WK29	WK30	WK31	WK32	WK33	WK34	WK35	WK36	WK37	WK38	WK39
a	b	c	d	e	f	g	h	i	j	k	l	m
WK40	WK41	WK42	WK43	WK44	WK45	WK46	WK47	WK48	WK49	WK50	WK51	WK52
n	o	p	q	r	s	t	u	v	w	x	y	z

Packing:

■ Reel Dimension (Unit: mm)

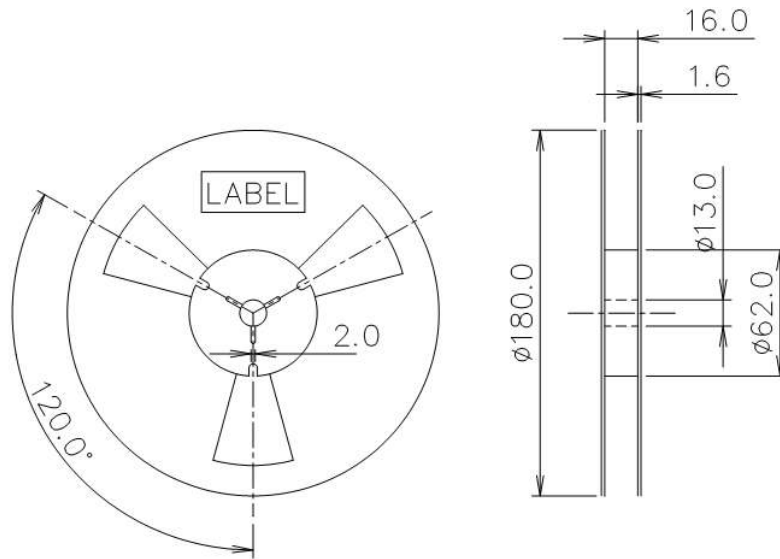

■ Tape Dimension (Unit: mm)

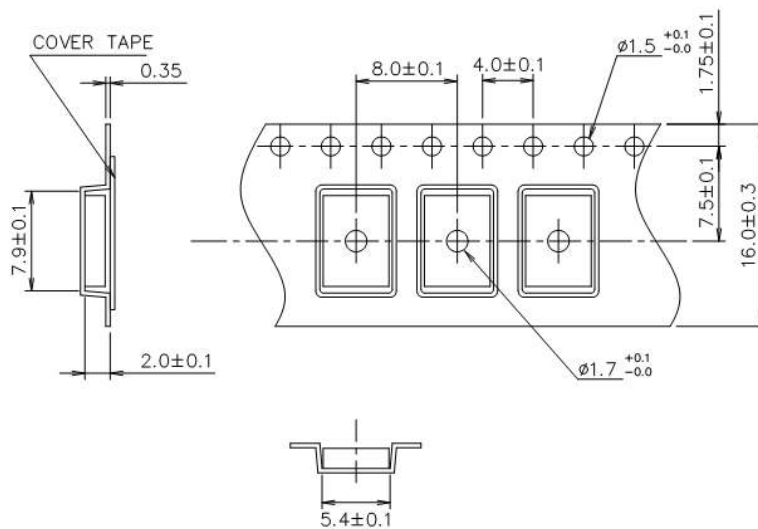

[NOTE]:

1. Unless otherwise specified tolerance on dimension +/-0.1 mm.
2. Material: conductive polystyrene with color black
3. 10 pitch cumulative tolerance +/-0.2 mm.
4. Packing Direction: dot or the logo of marking should be close to the hole of tape.

■ PACKING DIRECTION:

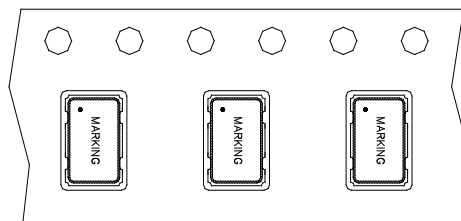

Packing Quantity/Packing: 1K pcs maximum per reel

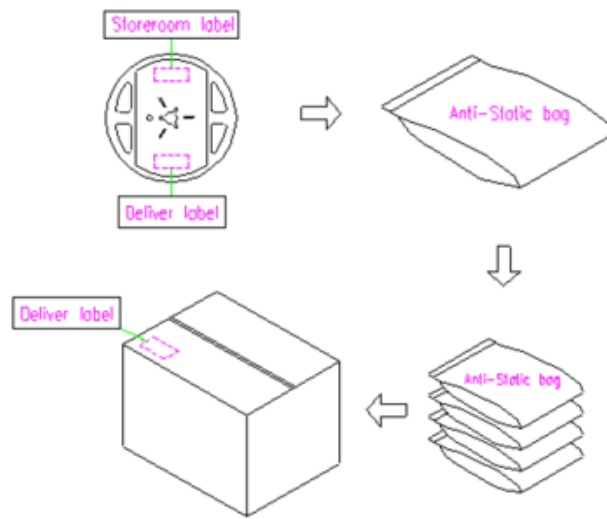

Reflow Profile:

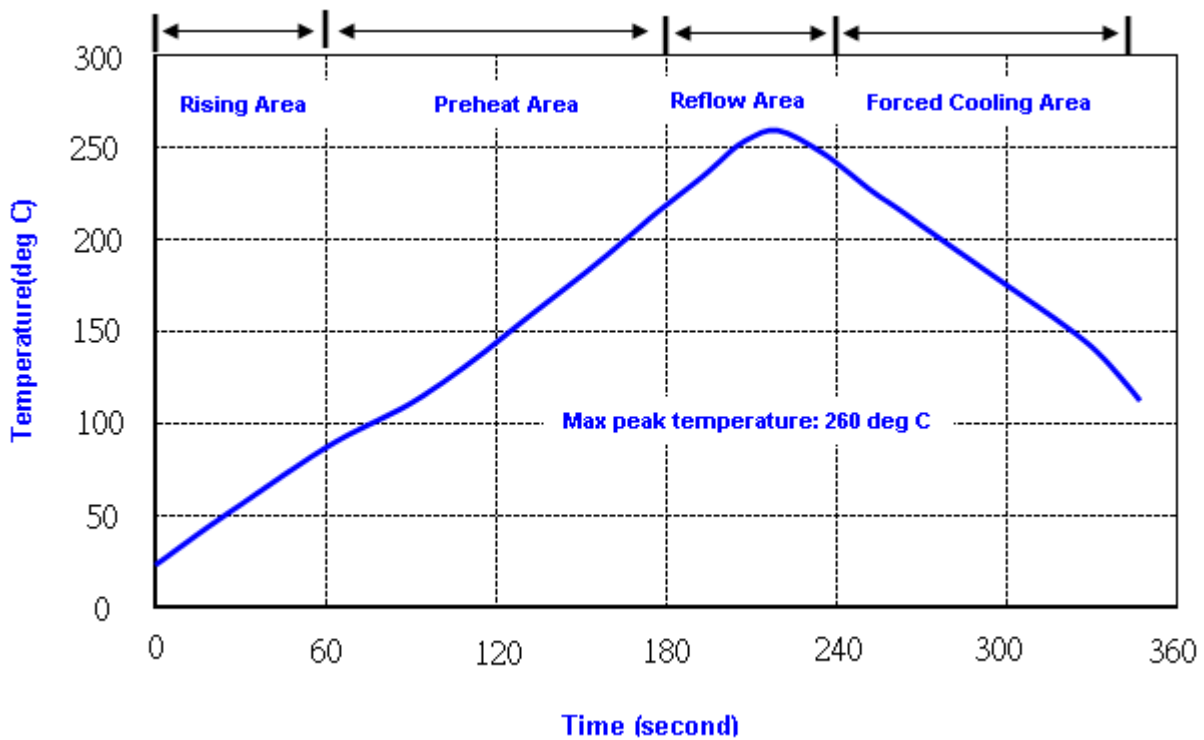

Note: 1. Max peak temperature: 260+/-5 deg C; Time: 10+/-2 sec
2. Temperature: 217+/-5 deg C; Time: 90~100 sec

Reliability Specifications

Test name	Test process / method	Reference standard
Mechanical characteristics		
resistance to Soldering heat (IR reflow)	Temp./ Duration : 260°C /10sec ×2 times Total time : 4min.(IR-reflow)	EIAJED-4701 -300(301)M(II)
Vibration	Total peak amplitude : 1.5mm Vibration frequency : 10 to 55 Hz Sweep period : 1.0 minute Vibration directions : 3 mutually perpendicular Duration : 2 hr / direc.	MIL-STD 202F method 201A
Mechanical Shock	directions : 3 impacts per axis Acceleration : 3000g's, +20/-0 % Duration : 0.3 ms (total 18 shocks) Waveform : Half-sine	MIL-STD 202F method 213C
Solderability	Solder Temperature:265±5°C Duration time: 5±0.5 seconds.	MIL-STD 883G method 2003
Environmental characteristics		
Thermal Shock	Heat cycle conditions -55 °C (30min) ↔ 125 °C (30min) * cycle time : 10 times	MIL-STD 883G method 1010.7
Humidity test	Temperature : 70 ± 2 °C Relative humidity : 90~95% Duration : 96 hours	MIL-STD 202F method 103B
Dry heat (Aging test)	Temperature : 125 ± 2 °C Duration : 168 hours	MIL-STD 883G method 1008.2 condition C
PCT test	Pressure: 2.06kg/cm ² (2.03*10 ⁵ pa) Temperature : 121 ± 2 °C Relative humidity : 100% Duration : 24 hours	EIAJED-4701-3 B-123A