

## CLP0424/428 Open Frame Power Supply

90 - 265Vac input; 24/28Vdc output; 450W Output Power



### Applications

- Industrial equipment
- Telecommunications equipment
- Robotics
- 3D Printers

### Description

In a small 3 x 5 inch footprint, the 24/28Vdc single-output CLP0424 open frame power supply delivers greater than 91 percent typical power efficiency and full load output at 50°C and 1m/s airflow. Protection features include output overcurrent (OCP), overvoltage (OVP), and overtemperature (OTP).

### Features

- Compact size 76.2 mm x 127 mm x 35 mm (3 in x 5 in x 1.38 in) with density of 21.4 W/in<sup>3</sup>
- Universal AC Input Range (90 - 265VAC)
- Output voltage of 24/28V (adjustable ±5%)
- Standby output of 5V @ 1A
- Standby input power consumption < 0.5W
- Maximum output current of 18.8A @ 24Vout, 16.1A @ 28V out (450W)
- High efficiency (>92% at full load, 230VAC in)
- Full load capability at 50°C and 1m/s airflow with derating at higher temperatures or lower airflows
- Capable of ≥340W out in sealed enclosure applications with enclosure ambient at 55°C
- Output overcurrent protection (non-latching)
- Overtemperature protection
- Output overvoltage protection
- Minimum of 11ms of holdup time at 450W out
- Parallelable with output current sharing
- Active power factor corrected input
- Conducted EMI - meets CISPR22 (EN55022) and FCC Class B requirements
- Meets IEC61000-4-5, Level 4 (2kV/4kV)
- Compliant to RoHS EU Directive 2002/95/EC
- UL and cUL approved to UL/CSA60950-1, TUV (EN60950-1), CE Mark (for LVD) and CB Report available
- ISO\*\* 9001 and ISO 14001 certified manufacturing facilities

\* UL is a registered trademark of Underwriters Laboratories, Inc.

† CSA is a registered trademark of Canadian Standards Association.

‡ VDE is a trademark of Verband Deutscher Elektrotechniker e.V.

\*\* ISO is a registered trademark of the International Organization of Standards

## CLP0424/428 Open Frame Power Supply

90 - 265Vac input; 24/28Vdc output; 450W Output Power

### Absolute Maximum Ratings

Stresses over the absolute maximum ratings can cause permanent damage to the device. These are absolute stress ratings only; functional operation of the device is not implied at these or any other conditions in excess of those given in the operations sections of the data sheet. Exposure to absolute maximum ratings for extended periods can adversely affect the device reliability.

| Parameter  | Device | Min | Max  | Unit |
|--|--------|-----|------|------|
| Input Voltage - Continuous   | All    | 90  | 265  | Vac  |
| For up to 10 seconds   | All    | 90  | 275  | Vac  |
| Operating Ambient Temperature see (Thermal Considerations section)<br>-40C Start Vout Stable after 20 minutes warm up period with 50% loading<br>All specifications met at -10C or above | All    | -40 | 85   | °C   |
| Storage Temperature  | All    | -40 | 85   | °C   |
| Humidity (non-condensing)  | All    | 5   | 95   | %    |
| Altitude   | All    |     | 5000 | m    |
| Isolation Voltage - Input to output  | All    |     | 3000 | Vac  |
| Input to safety ground   | All    |     | 1500 | Vac  |
| Outputs to safety ground   | All    |     | 50   | Vac  |

### Electrical Specifications

| Parameter  | Device          | Min  | Typ     | Max   | Unit          |
|--|-----------------|------|---------|-------|---------------|
| Operating Input Voltage  | All             | 90   | 115/230 | 265   | Vac           |
| Input Source Frequency   | All             | 0    | 50/60   | 63    | Hz            |
| Input Current ( $V_{IN} = 90\text{Vac}$ )  | All             |      |         | 6     | $A_{RMS}$     |
| Input Power Factor (230Vac, Full Load)   | All             | 0.95 |         |       |               |
| Inrush Transient Current ( $V_{IN} = 265\text{Vac}$ , $T_{amb} = 25^{\circ}\text{C}$ )   | All             |      |         | 60    | A Peak        |
| Leakage Current to earth ground ( $V_{IN} = 265\text{Vac}$ )   | All             |      |         | 3.5   | mA            |
| Output Voltage Setpoint  | 24V out Version |      | 24      |       | Vdc           |
|  | 28V out version |      | 28      |       | Vdc           |
| Output Voltage Tolerance (due to set point, temperature variations, load and line regulation)  | All             | -2   |         | 2     | %             |
| Output Voltage Adjustment Range  | 24V out Version | 22.8 | 24      | 25.2  | Vdc           |
|  | 28V out version | 26.6 | 28      | 29.4  | Vdc           |
| Output Remote Sense Range  | All             |      |         | 1     | Vdc           |
| Output Load Regulation   | All             |      |         | 1     | %Vout         |
| Output Line Regulation   | All             | -0.5 |         | 0.5   | %Vout         |
| Output Ripple and Noise - measured with 0.1 $\mu\text{F}$ ceramic capacitor in parallel with 470 $\mu\text{F}$ electrolytic capacitor (p-p with 20MHz Bandwidth) | All             |      |         | 350   | mV p-p        |
| Dynamic Load Response - 50% to 100% load transient, 1A/ $\mu\text{s}$ slew rate  | All             |      |         | 5%    | %             |
| Output voltage deviation   | All             |      |         | 500   | $\mu\text{s}$ |
| Settling Time  | All             |      |         |       |               |
| Output Current   | 24V out version | 0    |         | 18.75 | Adc           |
|  | 28V out version | 0    |         | 16.1  | Adc           |
| Output Current Limit Inception   | All             | 110  |         | 145   | % $I_{O,max}$ |
| Maximum Output Capacitance   | All             |      |         | 5000  | $\mu\text{F}$ |
| Standby Output Voltage   | All             |      | 5       |       | Vdc           |
| Standby Output Current   | All             |      |         | 1     | Adc           |
| Efficiency: $V_{IN} = 230\text{Vac}$ , 20% load  | All             | 88.0 |         |       | %             |
| 50% load   | All             | 92.0 |         |       | %             |
| 100% load  | All             | 88.0 |         |       | %             |
| $V_{IN} = 115\text{Vac}$ , 20% load  | All             | 87.0 |         |       | %             |
| 50% load   | All             | 90.0 |         |       | %             |
| 100% load  | All             | 87.0 |         |       | %             |

## CLP0424/428 Open Frame Power Supply

90 - 265Vac input; 24/28Vdc output; 450W Output Power

| Parameter  | Device | Min | Typ | Max | Unit |
|--|--------|-----|-----|-----|------|
| Holdup Time <sup>1</sup> - $V_{IN} = 115\text{Vac}$ , 450W load  | All    | 11  |     |     | ms   |
| $V_{IN} = 230\text{Vac}$ , 450W load   | All    | 11  |     |     | ms   |
| Input Power Consumption in Standby Mode (main output off, 0.2W load on standby output) AC input Version only | All    |     |     | 0.5 | W    |

### General Specifications

| Parameter   | Device | Symbol | Typ.         | Unit     |
|---|--------|--------|--------------|----------|
| Calculated Reliability based on Telcordia SR-332 Issue 2: Method 1 Case 3 ( $V_{IN}=230\text{Vac}$ , $I_o = 18.75\text{A}$ , $T_A = 40^\circ\text{C}$ , airflow 200LFM, 90% confidence) | All    | MTBF   | >750,000     | Hours    |
| Weight  | All    |        | 389<br>13.72 | g<br>oz. |

### Feature Specifications

| Parameter   | Device          | Min  | Typ | Max  | Unit          |
|---|-----------------|------|-----|------|---------------|
| On/Off Signal Interface - signal referenced to GND                | All             |      |     |      |               |
| Logic Low (Power Supply ON)                                       | All             |      |     |      |               |
| Input Low Current   | All             |      |     | 7    | mA            |
| Input Low Voltage   | All             |      |     | 1    | V             |
| Logic High (Power Supply OFF)                                     | All             |      |     |      |               |
| Input High Current  | All             |      |     | 600  | $\mu\text{A}$ |
| Input Voltage   | All             | 2.5  |     | 5.5  | V             |
| Delay from ON/OFF being enabled to start of output voltage rise   | All             |      |     | 200  | ms            |
| Output Voltage Rise Time (from 10 to 90% of final value)          | All             |      | 20  |      | ms            |
| Delay from Input being applied to all outputs being in regulation | All             |      |     | 1000 | ms            |
| Output Overvoltage Protection                                     | 24V out version | 27.6 |     | 32   | Vdc           |
|   | 28V out version | 32.2 |     | 37.3 | Vdc           |
| Input Under voltage lockout <sup>2</sup>                          |                 |      |     |      |               |
| Turn-on Threshold (100% load)                                     | All             |      |     | 90   | Vac           |
| Turn-off Threshold (100% load)                                    | All             |      |     | 88   | Vac           |
| DC OK - open collector, High when output available                |                 |      |     |      |               |
| Sink Current  | All             |      |     | 4    | mA            |
| Maximum Collector Voltage   | All             |      |     | 12   | V             |

<sup>1</sup> Holdup time may be lower at cold temperatures

<sup>2</sup> Under voltage lockout threshold may vary with output load current level - decreasing as load goes lower

## CLP0424/428 Open Frame Power Supply

90 - 265Vac input; 24/28Vdc output; 450W Output Power

### Environmental Specifications

| Parameter   | Device | Specification/Test   |
|---|--------|--|
| Radiated Emissions <sup>3</sup>   | All    | CISPR22 Class B with 3dB margin  |
| Conducted Emissions   | All    | CISPR22 Class B with 6dB margin  |
| ESD   | All    | IEC61000-4-2, Level 3  |
| Radiated Susceptibility <sup>4</sup>  | All    | IEC61000-4-3, Level 3  |
| Electrical Fast Transient Common Mode   | All    | IEC61000-4-4, Level 3  |
| Surge Immunity (note- overshoot or undershoot may be observed during an event > 5% for 20 us application dependent) | All    | IEC61000-4-5, Level 4  |
| Conducted RF Immunity   | All    | IEC61000-4-6, Level 3  |
| Input Voltage Dips  | All    | Output stays within regulation for either ½ cycle interruption or 25% dip from nominal line for 1 second |
| Input Harmonics   | All    | IEC61000-3-2   |
| Shock and Vibration   | All    | Per IPC-9592B, Class II  |

### Safety Specifications

| Parameter   | Device | Specification  |
|---|--------|--|
| Dielectric Withstand Voltage (between input and output) | All    | Minimum of 4,250Vdc for 1 minute   |
| Insulation Resistance (between input and output)        | All    | Minimum of 5 MΩ  |
| Safety Standards  | All    | Class 1, IEC60950, EN60950, with the following deviations: Nemko, UL 60950 (Recognized Component), cUL (Canadian Approval by UL) |

<sup>3</sup> Shall meet when tested in a suitable enclosure

<sup>4</sup> Shall meet when tested in a suitable enclosure

CLP0424/428 Open Frame Power Supply  
 90 - 265Vac input; 24/28Vdc output; 450W Output Power

Characteristic Curves

The following figures provide typical characteristics for the CLP0424 power supply

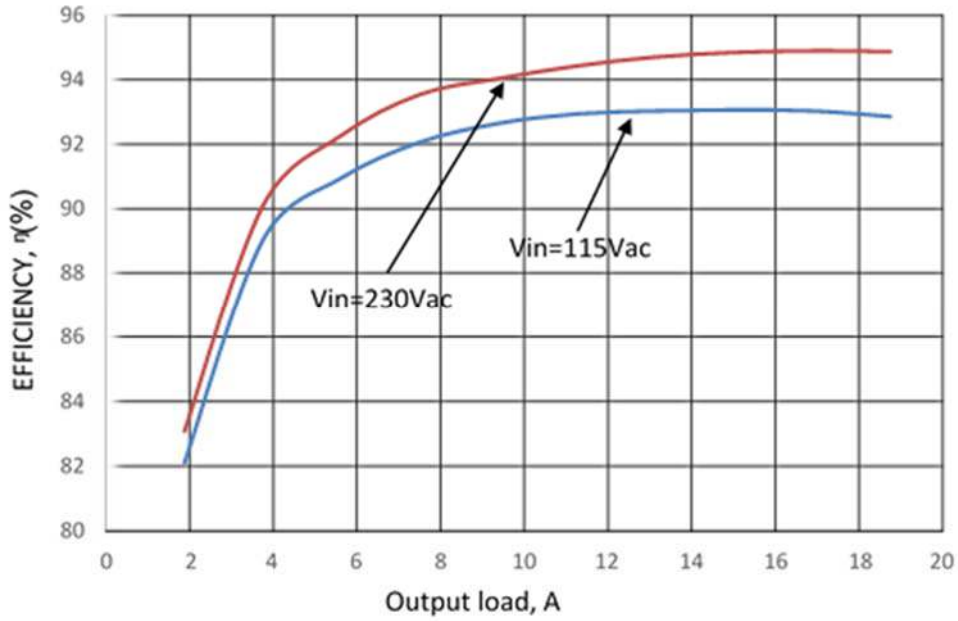

Figure 1. Power Supply Efficiency versus Output Current

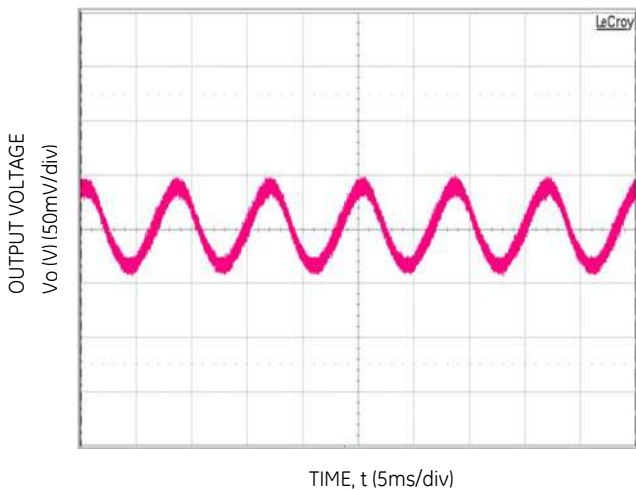

Figure 2. Typical output ripple and noise ( $V_{IN} = 230Vac$  100% load).

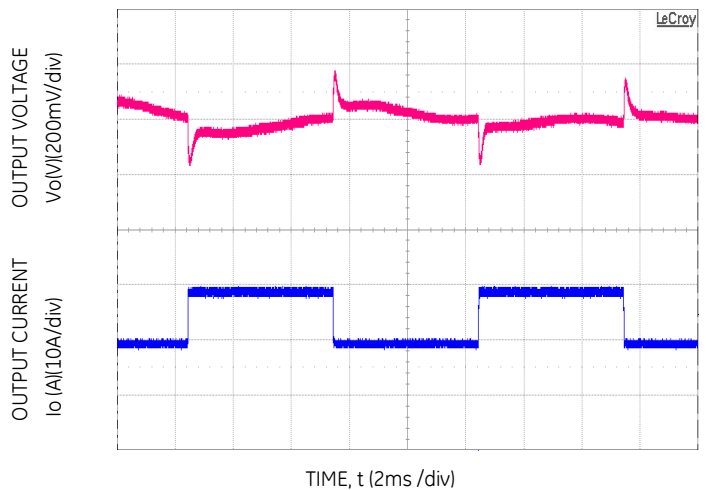

Figure 3. Transient Response to Dynamic Load change from 50% to 100% at  $V_{IN} = 230Vac$ .

# CLP0424/428 Open Frame Power Supply

90 - 265Vac input; 24/28Vdc output; 450W Output Power

## Characteristic Curves (cont.)

The following figures provide typical characteristics for the CLP0424 power supply

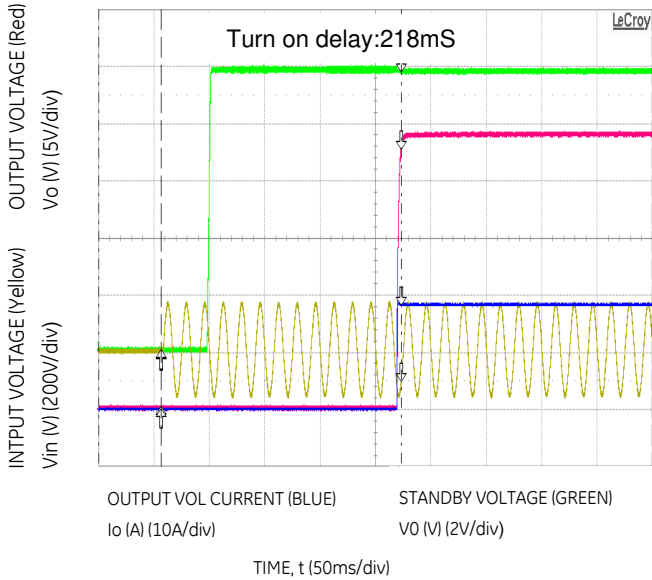

Figure 4. Typical Start-up ( $V_{IN} = 115\text{Vac}$ , Full Load).

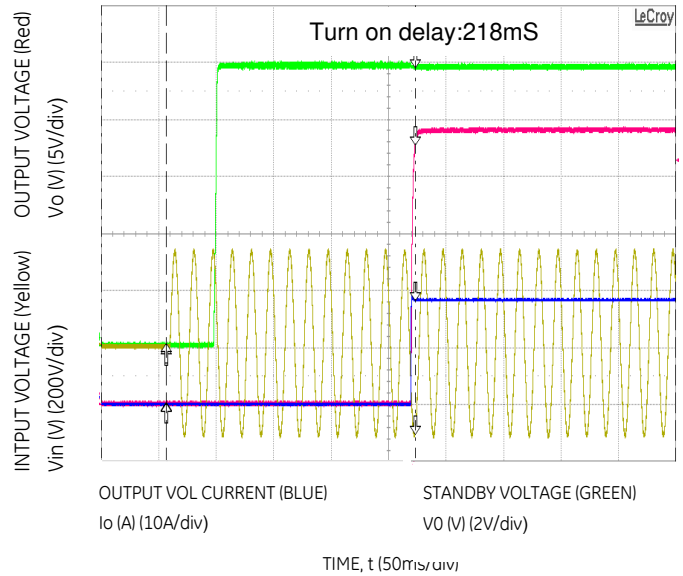

Figure 5. Typical Start-up ( $V_{IN} = 230\text{Vac}$ , Full Load).

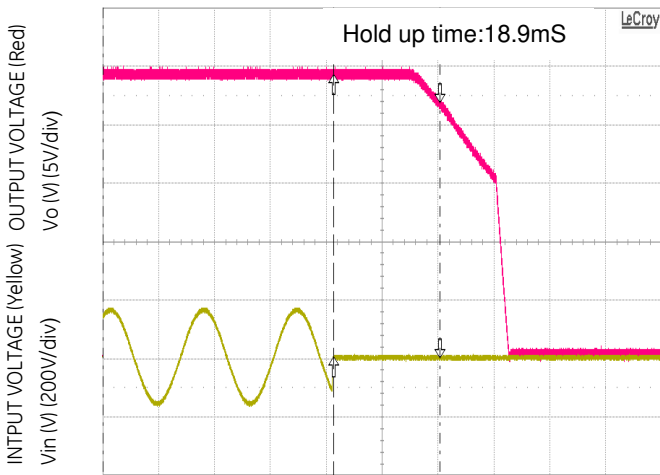

Figure 6. Typical Hold-up waveforms ( $V_{IN} = 115\text{V}$ , 100% Load)

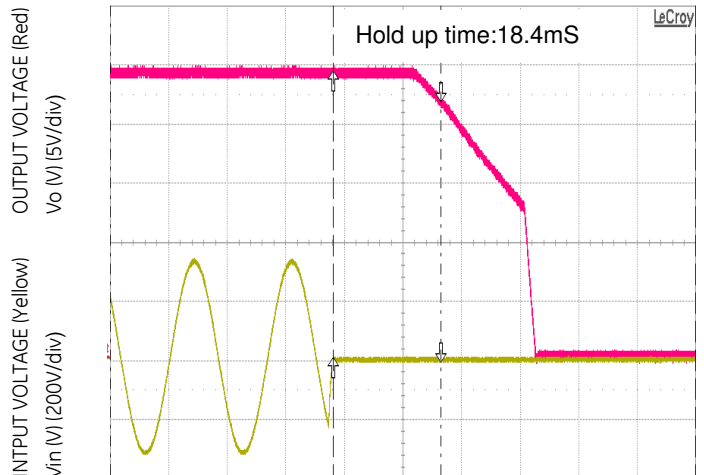
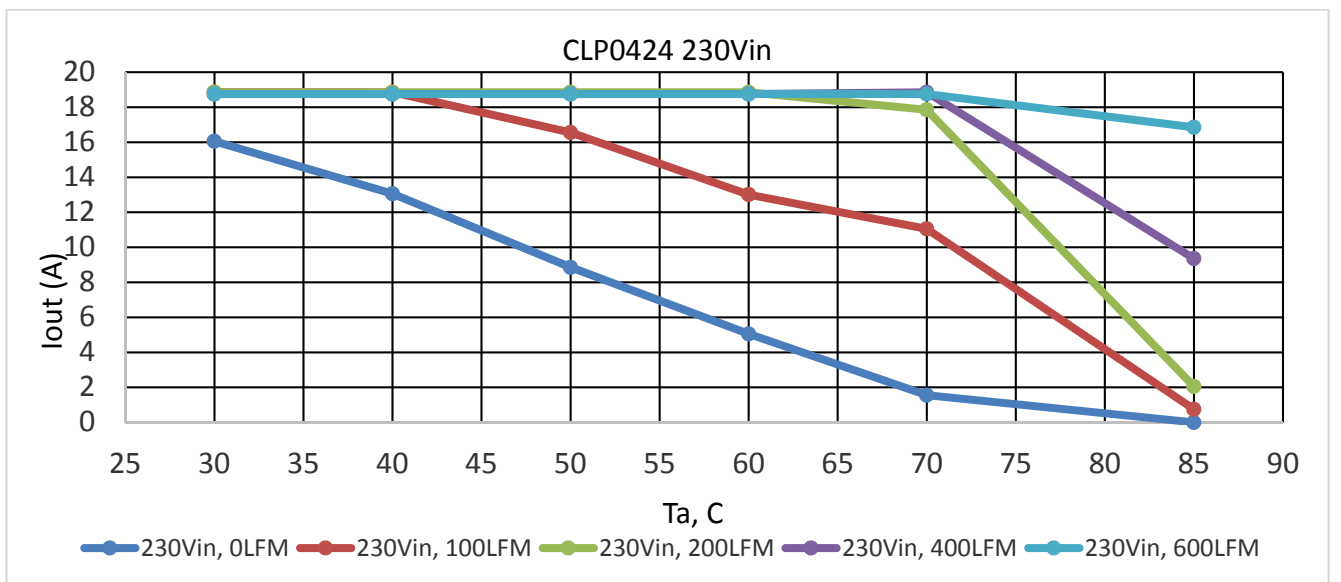
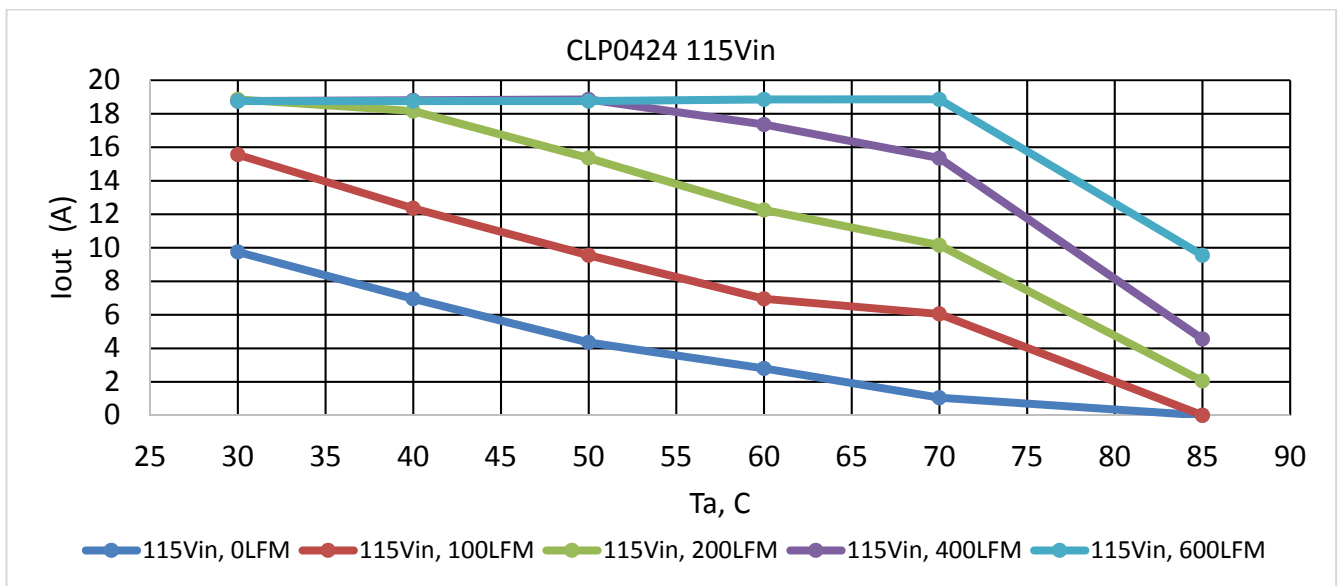

Figure 7. Typical Hold-up waveforms ( $V_{IN} = 230\text{V}$ , 100% load)

CLP0424/428 Open Frame Power Supply  
 90 - 265Vac input; 24/28Vdc output; 450W Output Power

Derating Curve (Open Frame Application)



CLP0424/428 Open Frame Power Supply  
 90 - 265Vac input; 24/28Vdc output; 450W Output Power

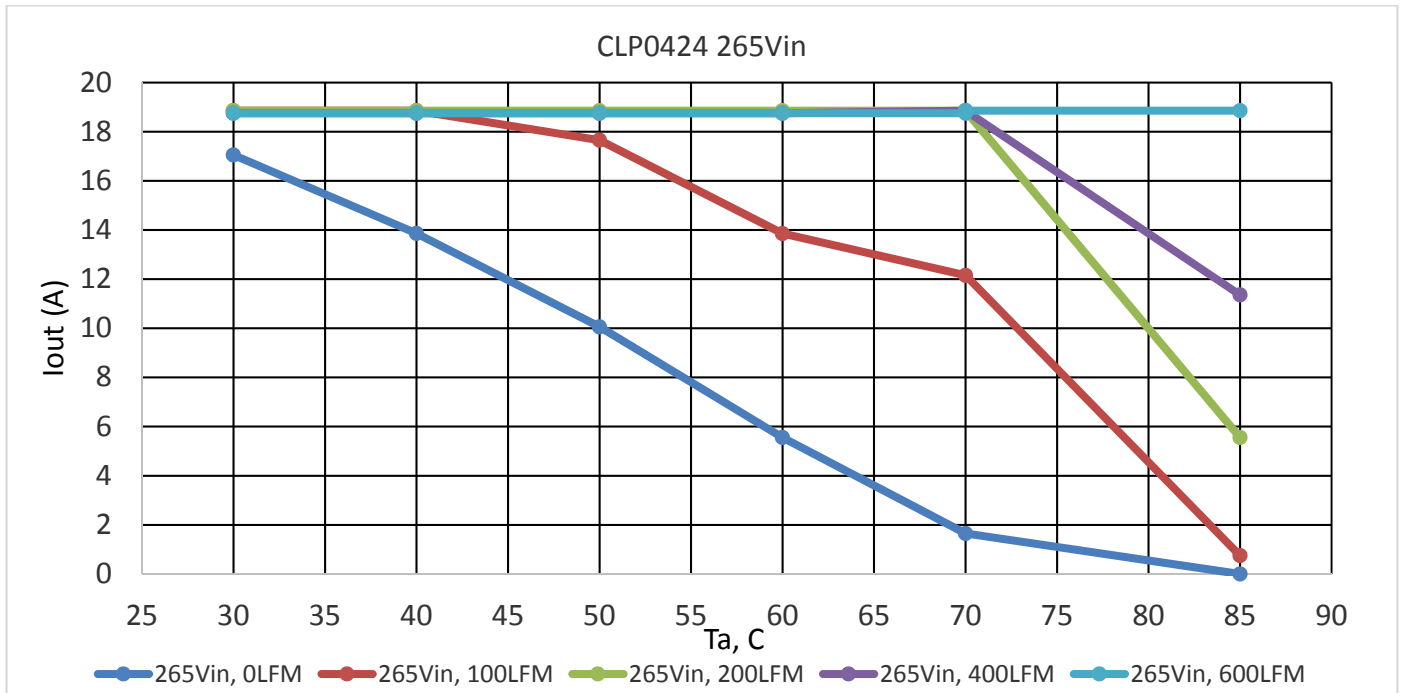

Derating Curve (Enclosure Application)

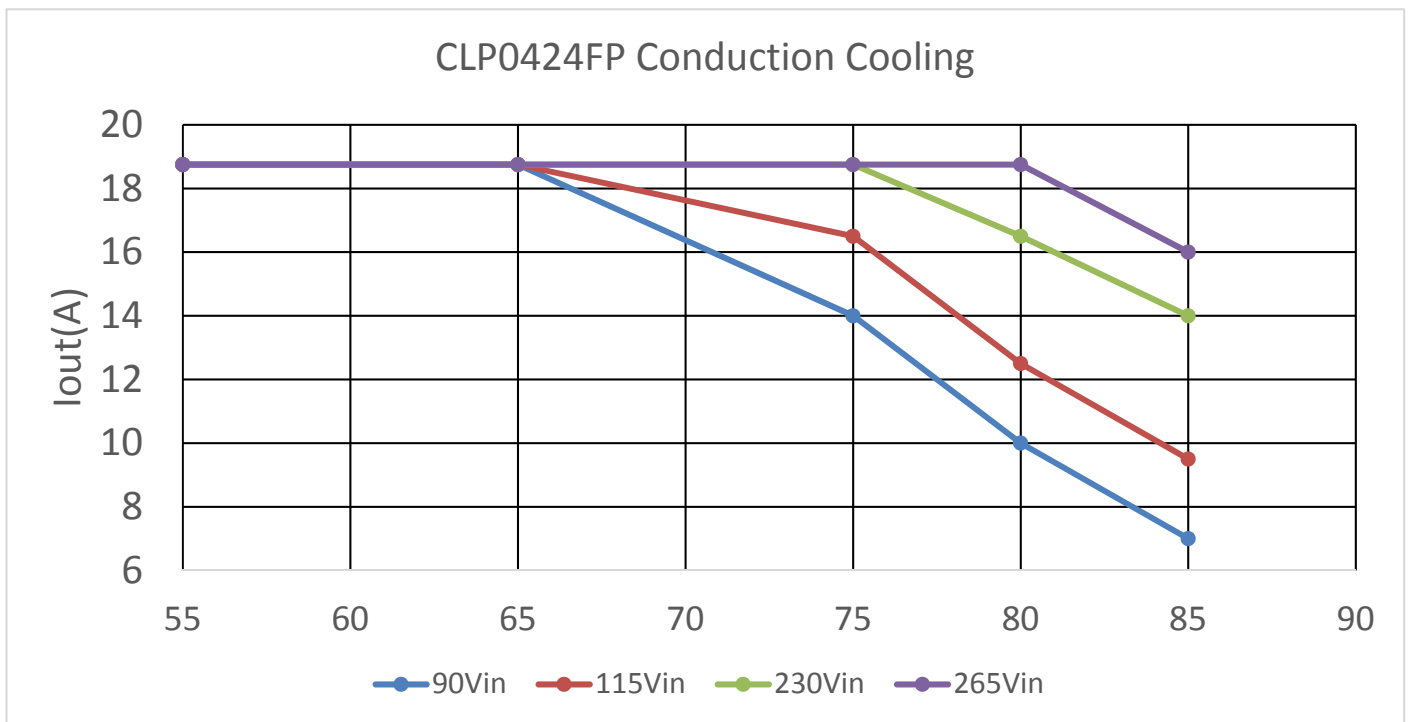



# CLP0424/428 Open Frame Power Supply

## 90 - 265Vac input; 24/28Vdc output; 450W Output Power

### Safety Considerations

The CLP0424 power supply is intended for inclusion in other equipment and the installer must ensure that it is complied with all the requirements of the end application. This product is only for inclusion by professional installers within other equipment and must not be operated as a stand-alone product. The power supply should meet Class 1, IEC60950, EN60950, with the following deviations: Nemko. UL 60950 (Recognized Component) C-UL (Canadian Approval by UL).

### Feature Descriptions

#### Standby Power Supply

A standby output of 5V in the CLP0424 power supply, shall come on when input in the operating range is applied.

#### Remote On/Off

The CLP0424 power supply shall feature a TTL-compatible On/Off control input. The power supply turns ON when the On/Off input goes low, and turns OFF when the input goes high. Note that if the On/Off pin is left unconnected, the power supply main output shall be ON.

#### Output Voltage Adjustment

The output voltage shall be capable of being adjusted between  $\pm 5\%$  around the nominal using a potentiometer on the power supply.

#### Remote Sense

The power supply shall have both positive and negative remote sense connections that can be connected to the positive and negative rails of the main output near the load. The power supply shall operate without the remote sense connections being made.

#### Overcurrent Protection

To provide protection in a fault condition (output overload), the power supply is equipped with internal current-limiting circuitry and can endure current limiting continuously. At the point of current-limit inception, the unit enters hiccup mode. The power supply operates normally once the output current is brought back into its specified range.

#### Overvoltage Protection

Overvoltage protection is a feature of the CLP0424 power supply that protects both the load and the power supply from an output overvoltage condition. When an overvoltage occurs, the power supply shuts down and latches off until the overvoltage condition is removed. It is necessary to recycle the input to restart the power supply when this protection is activated.

#### Overtemperature Protection

The CLP0424 also features overtemperature protection to provide additional protection in a fault condition. The power supply is equipped with a thermal shutdown circuit which detects excessive internal temperatures and shuts the unit down. Once the power supply goes into overtemperature

shutdown, it will cool before attempting to restart. The overtemperature protection circuit will typically kick in when the unit is operated at 450W output with an ambient temperature of TBD°C and 1m/s (200LFM) airflow.

#### Input Under Voltage Lockout

At input voltages below the input under voltage lockout limit, power supply operation shall be disabled. The power supply will begin to operate at an input voltage above the under-voltage lockout turn-on threshold

#### DC OK

The CLP0424 shall provide a DC OK signal that indicates when the output has come up and is in regulation. This is an open-collector type signal that goes high when the output is available and within regulation.

#### Power Good LED

A green LED on board the power supply shall illuminate when the main output voltage is above 90% of the nominal output voltage.

#### Paralleling with Active Output Current Sharing (option)

This power supply should be capable of parallel operation with active output current sharing in all options that have this feature. Paralleling of up to four power supplies should be supported. Paralleling will be accomplished by connecting the Current Share signals of multiple power supplies together. At load current levels above 20%, the output currents of multiple power supplies will be within  $\pm 5\%$  of the full load value.

# CLP0424/428 Open Frame Power Supply

90 - 265Vac input; 24/28Vdc output; 450W Output Power

## Thermal Considerations

The power supply can be operated in a variety of thermal environments, while sufficient cooling should be provided to ensure reliable operation.

Reliability should consider ambient temperature, airflow, power supply dissipation. A reduction in the operating temperature of the power supply will result in increased reliability. The power supply should be capable to deliver full output power of 450W/230Vac/200LFM at 50C or 450W/115Vacc/400LFM at 50C. The output power can be derated at higher output temperatures and lower airflow, and it should at least deliver 300W/115Vac/400LFM at 70C) of airflow.

In addition, in conduction-cooled applications with a suitable enclosure, the power supply should be capable to deliver 340W when the enclosure ambient temperature is 55°C, and 90VAC.

## Operation in a Sealed Enclosure

The CLP0424 power supply can also be operated in a sealed enclosure or in an environment where cooling is primarily via conduction. Figure 1 shows an arrangement where thermally conductive pads are used to transfer heat from the top and bottom of the power supply into the enclosure. Under such conditions, the power supply is capable of reduced power operation as shown in Table 1.

**Table 1. Output Power Capability when the CLP0424 is cooled primarily via conduction.**

| Cold Wall Temperature (°C) | Max. Output Power (W) |
|----------------------------|-----------------------|
| 90                         | 340                   |

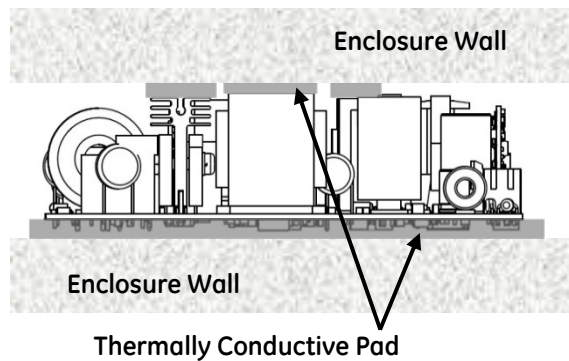
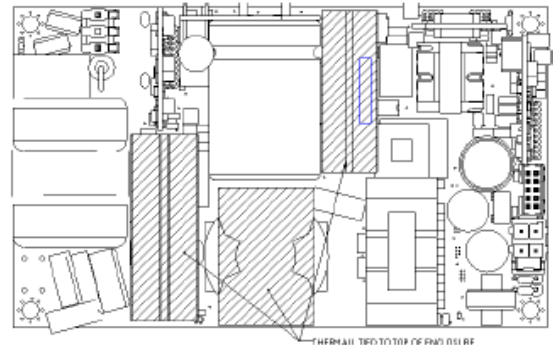

**Fig. 1. Example arrangement of the CLP0424 for sealed enclosure applications.**

## Heat Transfer Via Convection

Increased airflow through the power supply enhances the heat transfer via convection. Fig 2 shows the preferred airflow direction. Contact your GE technical representative for derating information in other airflow directions.

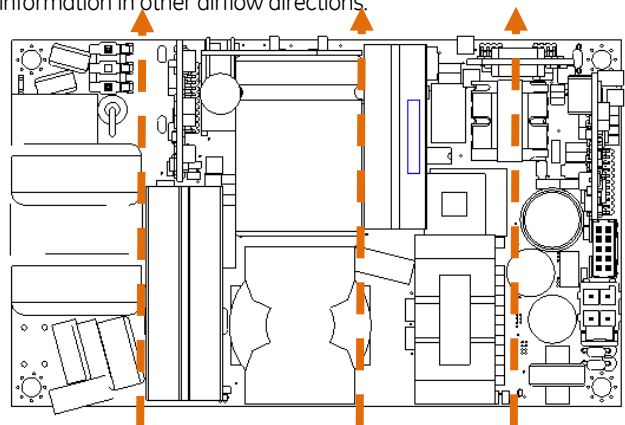

**Fig. 2. Preferred Airflow Direction for Cooling.**

# CLP0424/428 Open Frame Power Supply

90 - 265Vac input; 24/28Vdc output; 450W Output Power

## Mechanical Outline & Requirements

- The maximum outline of the power supply shall be 76.2 x 127 x 35mm

The top and sides views of the CLP0424 are shown below for reference.

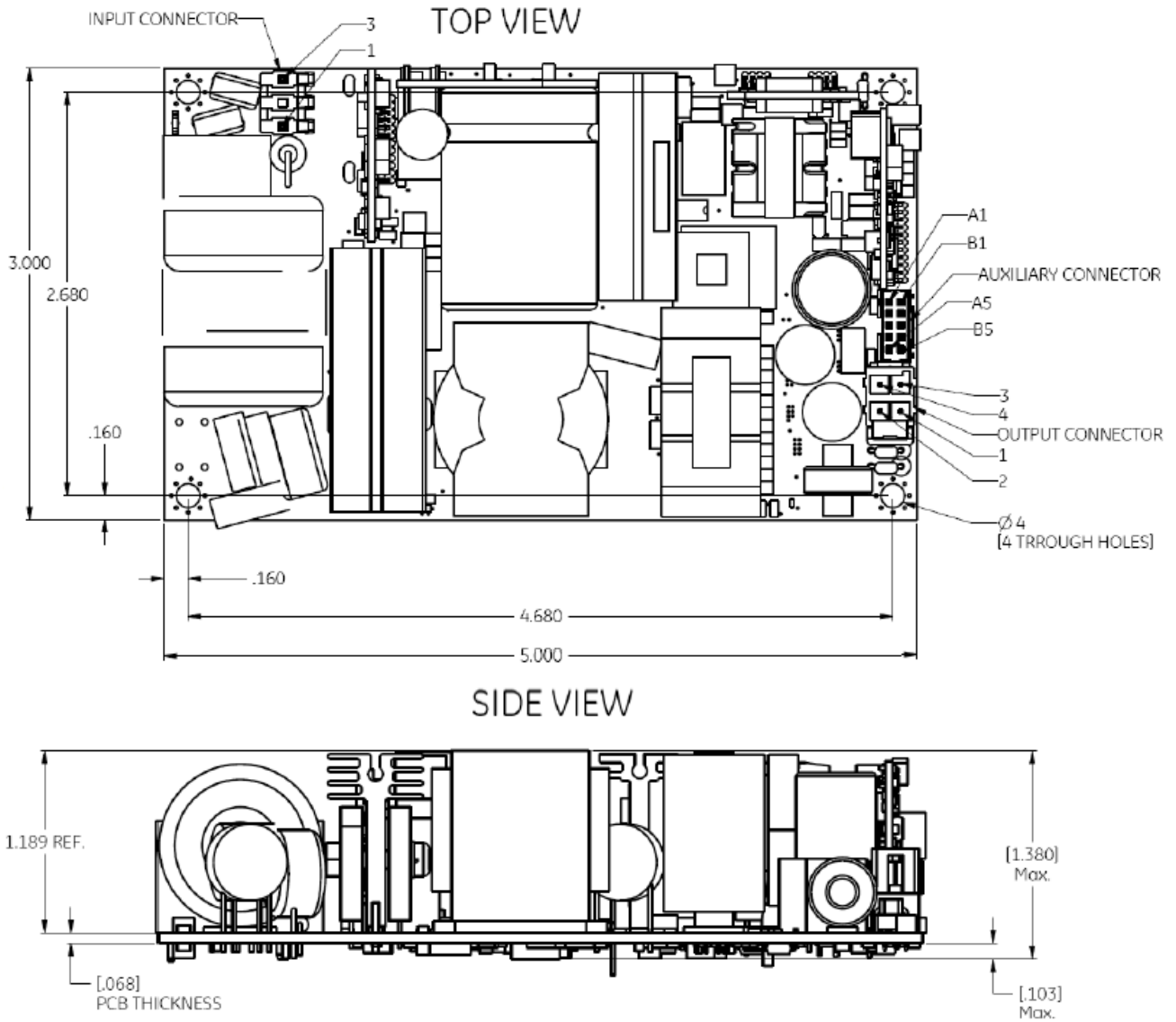

CLP0424/428 Open Frame Power Supply  
 90 - 265Vac input; 24/28Vdc output; 450W Output Power

Connector Information

| Connector                    | Connector on Power Supply                        | Housing:  |
|------------------------------|--|---|
| AC Input Connector (HDR200)  | 41671-3473 [Molex]<br>(450048210) or equivalent  | 09-93-0300---KK® 3.96mm Crimp Terminal Housing, Friction Ramp, 3 Circuits, Glow Wire Compatible |
| DC Output Connector (HDR600) | Molex 172298-1204 (450053094)<br>or equivalent   | Molex 1722581104 or equivalent  |
| Auxiliary Connector (HDR800) | 98414-G06-10ULF [FCI]<br>450047899 or equivalent | FCI 10073599-010 or equivalent  |

Pinout Information

| Input Connector (HDR1) |                  | DC Output Connector (HDR2) |                 | Auxiliary Connector (HDR3) |                |        |                   |
|------------------------|------------------|----------------------------|-----------------|----------------------------|----------------|--------|-------------------|
| PIN 1                  | Line, VIN (+)    | PINS 1                     | VOUT +          | PIN A1                     | 5V Standby     | PIN B1 | PARALLEL          |
| PIN 2                  | NC (Removed)     | PINS 2                     | VOUT +          | PIN A2                     | 5V Standby     | PIN B2 | 5V Standby Return |
| PIN 3                  | Neutral, VIN (-) | PINS 3                     | VOUT - (Return) | PIN A3                     | NC             | PIN B3 | 5V Standby Return |
|                        |                  | PINS 4                     | VOUT - (Return) | PIN A4                     | REMOTE SENSE + | PIN B4 | DC_OK             |
|                        |                  |                            |                 | PIN A5                     | REMOTE SENSE - | PIN B5 | ON/OFF            |

## CLP0424/428 Open Frame Power Supply

90 - 265Vac input; 24/28Vdc output; 450W Output Power

### Ordering Information

Please contact your GE Sales Representative for pricing, availability and optional features.

**Table 1. Device Codes**

| Device Code      | Input Voltage Range         | Output Voltage | Output Current | On/Off Control | Standby Supply | Temperature Range | Comcodes         |
|------------------|-----------------------------|----------------|----------------|----------------|----------------|-------------------|------------------|
| CLP0424FPXXXZ01A | 90 - 265Vac                 | 24Vdc          | 18.8A          | Negative Logic | 5V @ 1A        | -40 to 85°C       | CLP0424FPXXXZ01A |
| CLP0428FPXXXZ01A | 90 - 265Vac<br>100 - 300Vdc | 28Vdc          | 16.1A          | Negative Logic | 5V @ 1A        | -40 to 85°C       | TBD              |

## Contact Us

For more information, call us at

USA/Canada:

**+1 877 546 3243**, or +1 972 244 9288

Asia-Pacific:

+86.021.54279977\*808

Europe, Middle-East and Africa:

+49.89.878067-280

[www.gecriticalpower.com](http://www.gecriticalpower.com)



GE Critical Power reserves the right to make changes to the product(s) or information contained herein without notice, and no liability is assumed as a result of their use or application. No rights under any patent accompany the sale of any such product(s) or information.