

XPT IGBT Module

3~ Rectifier	Brake Chopper	3~ Inverter
$V_{RRM} = 1600\text{ V}$	$V_{CES} = 1200\text{ V}$	$V_{CES} = 1200\text{ V}$
$I_{DAV} = 135\text{ A}$	$I_{C25} = 60\text{ A}$	$I_{C25} = 85\text{ A}$
$I_{TSM} = 700\text{ A}$	$V_{CE(sat)} = 1.8\text{ V}$	$V_{CE(sat)} = 1.8\text{ V}$

6-Pack + 3~ Rectifier Bridge, half-controlled (high-side) & Brake Unit + NTC

Part number

MIXA60WH1200TEH

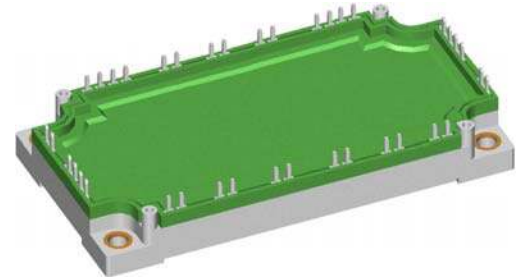

Backside: isolated

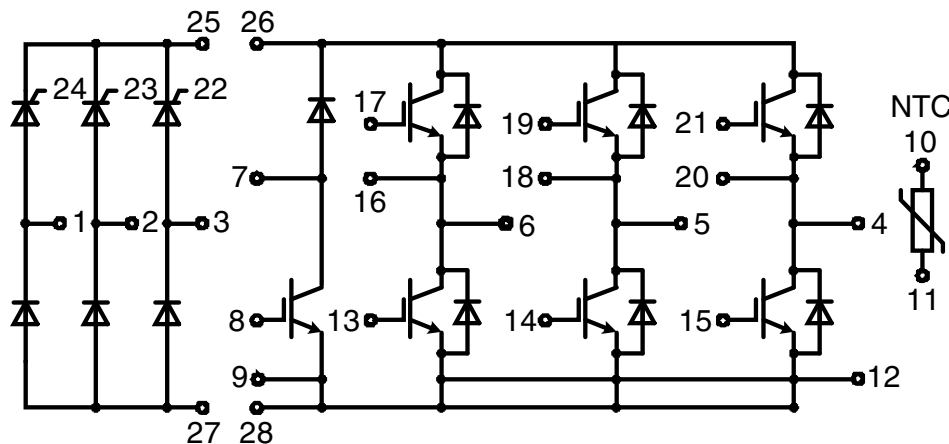

Features / Advantages:

- Thyristor/Standard Rectifier for line frequency
- Easy paralleling due to the positive temperature coefficient of the on-state voltage
- Rugged XPT design (Xtreme light Punch Through) results in:
 - short circuit rated for 10 μsec .
 - very low gate charge
 - low EMI
 - square RBSOA @ 3x I_c
- Thin wafer technology combined with the XPT design results in a competitive low $V_{CE(sat)}$
- SONIC™ diode
 - fast and soft reverse recovery
 - low operating forward voltage

Applications:

- AC motor drives
- Solar inverter
- Medical equipment
- Uninterruptible power supply
- Air-conditioning systems
- Welding equipment
- Switched-mode and resonant-mode power supplies
- Inductive heating, cookers
- Pumps, Fans

Package:

- Housing: E3-Pack
- International standard package
- RoHS compliant
- Isolation voltage: 3600 V~
- Advanced power cycling

Rectifier			Ratings			
Symbol	Definition	Conditions	min.	typ.	max.	Unit
$V_{RSM/DSM}$	max. non-repetitive reverse/forward blocking voltage	$T_{VJ} = 25^{\circ}\text{C}$			1700	V
$V_{RRM/DRM}$	max. repetitive reverse/forward blocking voltage	$T_{VJ} = 25^{\circ}\text{C}$			1600	V
I_{RD}	reverse current, drain current	$V_{R/D} = 1600\text{ V}$	$T_{VJ} = 25^{\circ}\text{C}$		100	μA
		$V_{R/D} = 1600\text{ V}$	$T_{VJ} = 150^{\circ}\text{C}$		20	mA
V_T	forward voltage drop	$I_T = 80\text{ A}$	$T_{VJ} = 25^{\circ}\text{C}$		1.43	V
		$I_T = 160\text{ A}$			1.86	V
		$I_T = 80\text{ A}$	$T_{VJ} = 125^{\circ}\text{C}$		1.42	V
		$I_T = 160\text{ A}$			1.97	V
I_{DAV}	bridge output current	$T_C = 80^{\circ}\text{C}$	$T_{VJ} = 150^{\circ}\text{C}$		135	A
		180° sine $d = 1/3$				
V_{T0}	threshold voltage	} for power loss calculation only	$T_{VJ} = 150^{\circ}\text{C}$		0.85	V
r_T	slope resistance				7.1	m Ω
R_{thJC}	thermal resistance junction to case				0.65	K/W
R_{thCH}	thermal resistance case to heatsink			0.10		K/W
P_{tot}	total power dissipation		$T_C = 25^{\circ}\text{C}$		190	W
I_{TSM}	max. forward surge current	$t = 10\text{ ms}; (50\text{ Hz}), \text{ sine}$	$T_{VJ} = 45^{\circ}\text{C}$		700	A
		$t = 8,3\text{ ms}; (60\text{ Hz}), \text{ sine}$	$V_R = 0\text{ V}$		755	A
		$t = 10\text{ ms}; (50\text{ Hz}), \text{ sine}$	$T_{VJ} = 150^{\circ}\text{C}$		595	A
		$t = 8,3\text{ ms}; (60\text{ Hz}), \text{ sine}$	$V_R = 0\text{ V}$		645	A
I^2t	value for fusing	$t = 10\text{ ms}; (50\text{ Hz}), \text{ sine}$	$T_{VJ} = 45^{\circ}\text{C}$		2.45	kA ² s
		$t = 8,3\text{ ms}; (60\text{ Hz}), \text{ sine}$	$V_R = 0\text{ V}$		2.37	kA ² s
		$t = 10\text{ ms}; (50\text{ Hz}), \text{ sine}$	$T_{VJ} = 150^{\circ}\text{C}$		1.77	kA ² s
		$t = 8,3\text{ ms}; (60\text{ Hz}), \text{ sine}$	$V_R = 0\text{ V}$		1.73	kA ² s
C_J	junction capacitance	$V_R = 400\text{ V}$ $f = 1\text{ MHz}$	$T_{VJ} = 25^{\circ}\text{C}$		32	pF
P_{GM}	max. gate power dissipation	$t_p = 30\text{ }\mu\text{s}$	$T_C = 150^{\circ}\text{C}$		10	W
		$t_p = 300\text{ }\mu\text{s}$			5	W
P_{GAV}	average gate power dissipation				0.5	W
$(di/dt)_{cr}$	critical rate of rise of current	$T_{VJ} = 125^{\circ}\text{C}; f = 50\text{ Hz}$ repetitive, $I_T = 150\text{ A}$			100	A/ μs
		$t_p = 200\text{ }\mu\text{s}; di_G/dt = 0.45\text{ A}/\mu\text{s}$ non-repet., $I_T = 45\text{ A}$			500	A/ μs
$(dv/dt)_{cr}$	critical rate of rise of voltage	$V_D = 2/3 V_{DRM}$	$T_{VJ} = 125^{\circ}\text{C}$		1000	V/ μs
		$R_{GK} = \infty$; method 1 (linear voltage rise)				
V_{GT}	gate trigger voltage	$V_D = 6\text{ V}$	$T_{VJ} = 25^{\circ}\text{C}$		1.5	V
			$T_{VJ} = -40^{\circ}\text{C}$		1.6	V
I_{GT}	gate trigger current	$V_D = 6\text{ V}$	$T_{VJ} = 25^{\circ}\text{C}$		78	mA
			$T_{VJ} = -40^{\circ}\text{C}$		200	mA
V_{GD}	gate non-trigger voltage	$V_D = 2/3 V_{DRM}$	$T_{VJ} = 125^{\circ}\text{C}$		0.2	V
I_{GD}	gate non-trigger current				5	mA
I_L	latching current	$t_p = 200\text{ }\mu\text{s}$	$T_{VJ} = 25^{\circ}\text{C}$		450	mA
		$I_G = 10\text{ A}; di_G/dt = 0.45\text{ A}/\mu\text{s}$				
I_H	holding current	$V_D = 6\text{ V}$ $R_{GK} = \infty$	$T_{VJ} = 25^{\circ}\text{C}$		100	mA
t_{gd}	gate controlled delay time	$V_D = 1/2 V_{DRM}$	$T_{VJ} = 25^{\circ}\text{C}$		2	μs
		$I_G = 0.45\text{ A}; di_G/dt = 0.45\text{ A}/\mu\text{s}$				
t_q	turn-off time	$V_R = 100\text{ V}; I_T = 20\text{ A}; V_D = 2/3 V_{DRM}$ $T_{VJ} = 150^{\circ}\text{C}$			150	μs
		$di/dt = 10\text{ A}/\mu\text{s}; dv/dt = 15\text{ V}/\mu\text{s}; t_p = 200\text{ }\mu\text{s}$				

Brake IGBT				Ratings			
Symbol	Definition	Conditions	min.	typ.	max.	Unit	
V_{CES}	collector emitter voltage	$T_{VJ} = 25^{\circ}\text{C}$			1200	V	
V_{GES}	max. DC gate voltage				± 20	V	
V_{GEM}	max. transient collector gate voltage				± 30	V	
I_{C25}	collector current	$T_C = 25^{\circ}\text{C}$			60	A	
I_{C80}		$T_C = 80^{\circ}\text{C}$			40	A	
P_{tot}	total power dissipation	$T_C = 25^{\circ}\text{C}$			195	W	
$V_{CE(sat)}$	collector emitter saturation voltage	$I_C = 35\text{ A}; V_{GE} = 15\text{ V}$			1.8	V	
					2.1	V	
$V_{GE(th)}$	gate emitter threshold voltage	$I_C = 1.5\text{ mA}; V_{GE} = V_{CE}$	5.4	5.9	6.5	V	
I_{CES}	collector emitter leakage current	$V_{CE} = V_{CES}; V_{GE} = 0\text{ V}$			2.1	mA	
					0.1	mA	
I_{GES}	gate emitter leakage current	$V_{GE} = \pm 20\text{ V}$			500	nA	
$Q_{G(on)}$	total gate charge	$V_{CE} = 600\text{ V}; V_{GE} = 15\text{ V}; I_C = 35\text{ A}$		106		nC	
$t_{d(on)}$	turn-on delay time	inductive load $V_{CE} = 600\text{ V}; I_C = 35\text{ A}$ $V_{GE} = \pm 15\text{ V}; R_G = 27\ \Omega$	$T_{VJ} = 125^{\circ}\text{C}$		70	ns	
t_r	current rise time				40	ns	
$t_{d(off)}$	turn-off delay time				250	ns	
t_f	current fall time				100	ns	
E_{on}	turn-on energy per pulse				3.8	mJ	
E_{off}	turn-off energy per pulse				4.1	mJ	
RBSOA	reverse bias safe operating area	$V_{GE} = \pm 15\text{ V}; R_G = 27\ \Omega$	$T_{VJ} = 125^{\circ}\text{C}$				
I_{CM}		$V_{CEK} = 1200\text{ V}$			105	A	
SCSOA	short circuit safe operating area						
t_{SC}	short circuit duration	$V_{CE} = 900\text{ V}; V_{GE} = \pm 15\text{ V}$	$T_{VJ} = 125^{\circ}\text{C}$		10	μs	
I_{SC}	short circuit current	$R_G = 27\ \Omega$; non-repetitive		140		A	
R_{thJC}	thermal resistance junction to case				0.64	K/W	
R_{thCH}	thermal resistance case to heatsink			0.10		K/W	
Brake Diode							
V_{RRM}	max. repetitive reverse voltage		$T_{VJ} = 25^{\circ}\text{C}$		1200	V	
I_{F25}	forward current		$T_C = 25^{\circ}\text{C}$		44	A	
I_{F80}			$T_C = 80^{\circ}\text{C}$		29	A	
V_F	forward voltage	$I_F = 30\text{ A}$	$T_{VJ} = 25^{\circ}\text{C}$		2.20	V	
			$T_{VJ} = 125^{\circ}\text{C}$		1.95	V	
I_R	reverse current	$V_R = V_{RRM}$	$T_{VJ} = 25^{\circ}\text{C}$		0.1	mA	
			$T_{VJ} = 125^{\circ}\text{C}$		0.15	mA	
Q_{rr}	reverse recovery charge	$V_R = 600\text{ V}$ $-di_F/dt = 600\text{ A}/\mu\text{s}$ $I_F = 30\text{ A}$	$T_{VJ} = 125^{\circ}\text{C}$		3.5	μC	
I_{RM}	max. reverse recovery current				30	A	
t_{rr}	reverse recovery time				350	ns	
E_{rec}	reverse recovery energy				0.9	mJ	
R_{thJC}	thermal resistance junction to case				1.2	K/W	
R_{thCH}	thermal resistance case to heatsink			0.10		K/W	

Inverter IGBT				Ratings			
Symbol	Definition	Conditions	min.	typ.	max.	Unit	
V_{CES}	collector emitter voltage	$T_{VJ} = 25^{\circ}\text{C}$			1200	V	
V_{GES}	max. DC gate voltage				± 20	V	
V_{GEM}	max. transient collector gate voltage				± 30	V	
I_{C25}	collector current	$T_C = 25^{\circ}\text{C}$			85	A	
I_{C80}		$T_C = 80^{\circ}\text{C}$			60	A	
P_{tot}	total power dissipation	$T_C = 25^{\circ}\text{C}$			290	W	
$V_{CE(sat)}$	collector emitter saturation voltage	$I_C = 55\text{ A}; V_{GE} = 15\text{ V}$			1.8	V	
					2.1	V	
$V_{GE(th)}$	gate emitter threshold voltage	$I_C = 2\text{ mA}; V_{CE} = V_{CE}$	5.4	5.9	6.5	V	
I_{CES}	collector emitter leakage current	$V_{CE} = V_{CES}; V_{GE} = 0\text{ V}$			0.5	mA	
					0.2	mA	
I_{GES}	gate emitter leakage current	$V_{GE} = \pm 20\text{ V}$			500	nA	
$Q_{G(on)}$	total gate charge	$V_{CE} = 600\text{ V}; V_{GE} = 15\text{ V}; I_C = 55\text{ A}$		165		nC	
$t_{d(on)}$	turn-on delay time	inductive load $V_{CE} = 600\text{ V}; I_C = 55\text{ A}$ $V_{GE} = \pm 15\text{ V}; R_G = 15\ \Omega$		70		ns	
t_r	current rise time			40		ns	
$t_{d(off)}$	turn-off delay time			250		ns	
t_f	current fall time			100		ns	
E_{on}	turn-on energy per pulse			4.5		mJ	
E_{off}	turn-off energy per pulse			5.5		mJ	
R_{BSOA}	reverse bias safe operating area	$V_{GE} = \pm 15\text{ V}; R_G = 15\ \Omega$					
I_{CM}		$V_{CEmax} = 1200\text{ V}$			150	A	
R_{SCSOA}	short circuit safe operating area	$V_{CEmax} = 1200\text{ V}$					
t_{SC}	short circuit duration	$V_{CE} = 900\text{ V}; V_{GE} = \pm 15\text{ V}$			10	μs	
I_{SC}	short circuit current	$R_G = 15\ \Omega; \text{non-repetitive}$		200		A	
R_{thJC}	thermal resistance junction to case				0.43	K/W	
R_{thCH}	thermal resistance case to heatsink			0.10		K/W	
Inverter Diode							
V_{RRM}	max. repetitive reverse voltage	$T_{VJ} = 25^{\circ}\text{C}$			1200	V	
I_{F25}	forward current	$T_C = 25^{\circ}\text{C}$			88	A	
I_{F80}		$T_C = 80^{\circ}\text{C}$			59	A	
V_F	forward voltage	$I_F = 60\text{ A}$			2.20	V	
					1.95	V	
I_R	reverse current	$V_R = V_{RRM}$			0.3	mA	
					1.2	mA	
Q_{rr}	reverse recovery charge	$V_R = 600\text{ V}$ $-di_F/dt = 1200\text{ A}/\mu\text{s}$ $I_F = 60\text{ A}; V_{GE} = 0\text{ V}$		8		μC	
I_{RM}	max. reverse recovery current			60		A	
t_{rr}	reverse recovery time			350		ns	
E_{rec}	reverse recovery energy			2.5		mJ	
R_{thJC}	thermal resistance junction to case				0.6	K/W	
R_{thCH}	thermal resistance case to heatsink			0.10		K/W	

Package E3-Pack			Ratings			
Symbol	Definition	Conditions	min.	typ.	max.	Unit
I_{RMS}	RMS current	per terminal			300	A
T_{stg}	storage temperature		-40		125	°C
T_{VJ}	virtual junction temperature		-40		150	°C
Weight				270		g
M_D	mounting torque		3		6	Nm
V_{ISOL}	isolation voltage	t = 1 second	3600			V
		t = 1 minute	3000			V
$d_{Spp/App}$	creepage distance on surface / striking distance through air	terminal to terminal	6.0			mm
$d_{Spb/Apb}$		terminal to backside	12.0			mm

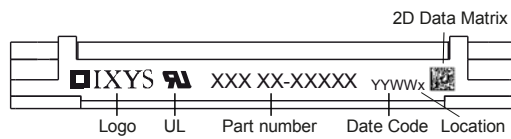
Part number

M = Module
 I = IGBT
 X = XPT IGBT
 A = Gen 1 / std
 60 = Current Rating [A]
 WH = 6-Pack + 3~ Rectifier Bridge, half-controlled (high-side) & Brake Unit
 1200 = Reverse Voltage [V]
 T = Thermistor \ Temperature sensor
 EH = E3-Pack

Ordering	Part Number	Marking on Product	Delivery Mode	Quantity	Code No.
Standard	MIXA60WH1200TEH	MIXA60WH1200TEH	Box	5	509622

Similar Part	Package	Voltage class
MIXA60WB1200TEH	E3-Pack	1200

Temperature Sensor NTC

Symbol	Definition	Conditions	min.	typ.	max.	Unit
R_{25}	resistance	$T_{VJ} = 25^\circ$	4.75	5	5.25	k Ω
$B_{25/50}$	temperature coefficient			3375		K

Equivalent Circuits for Simulation

* on die level

 $T_{VJ} = 150^\circ\text{C}$

		Rectifier	Brake IGBT	Brake Diode	Inverter IGBT	Inverter Diode	
V_0	threshold voltage	0.85	1.1	1.2	1.1	1.22	V
R_0	slope resistance *	3.9	40	27	25.1	13	m Ω

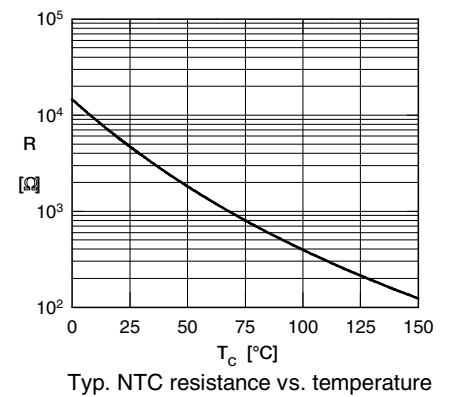

Outlines E3-Pack

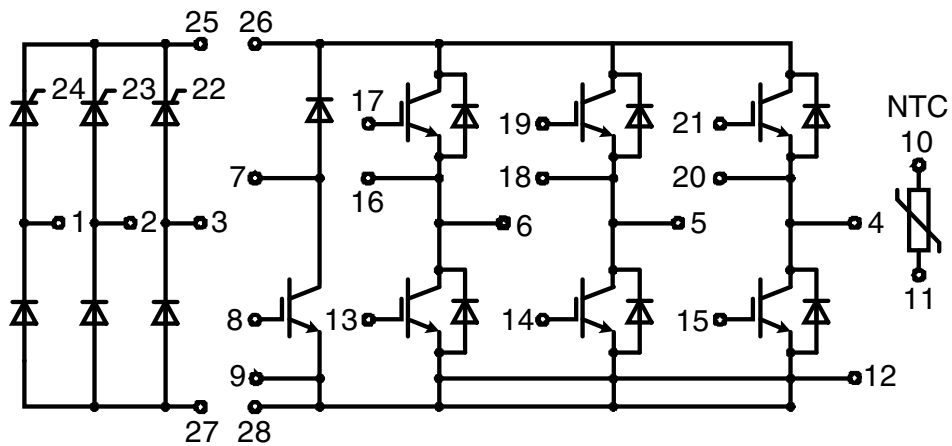
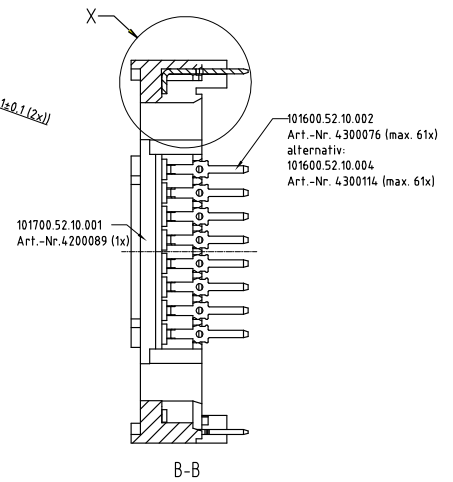
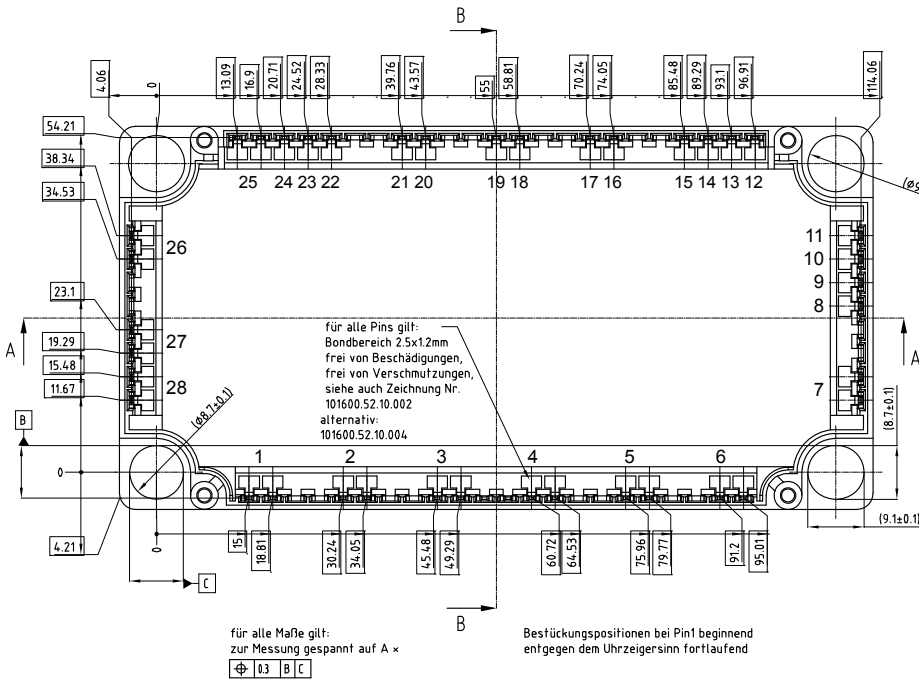
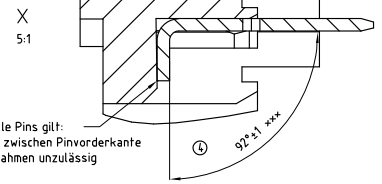
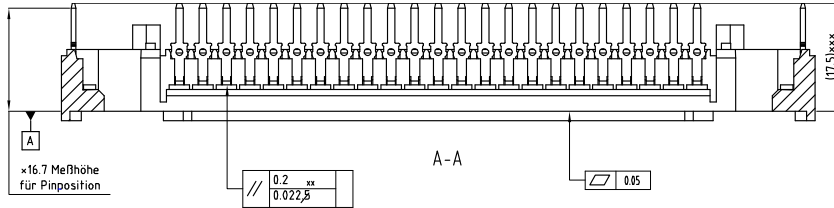

Rectifier

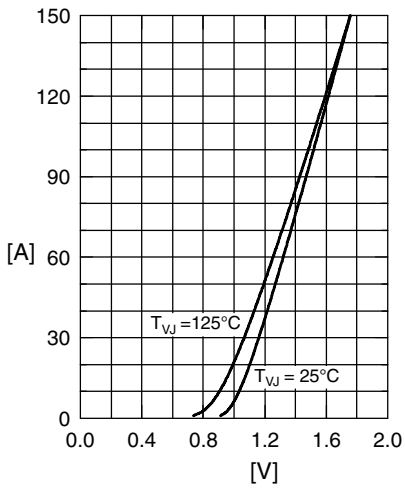

Fig.1 Forward current versus voltage drop per diode

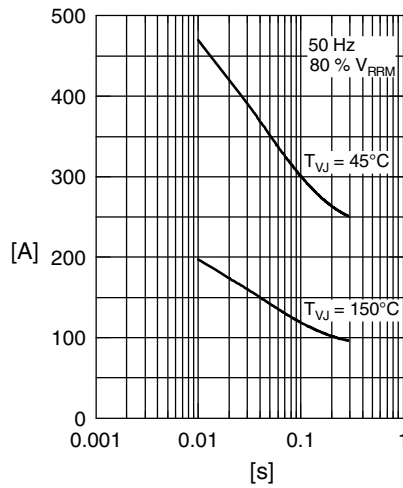

Fig.2 Surge overload current

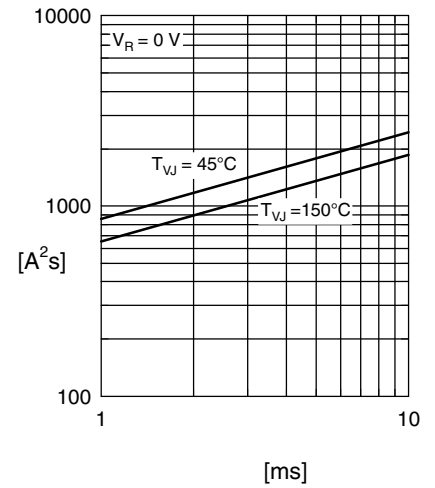

Fig.3 I^2t versus time per diode

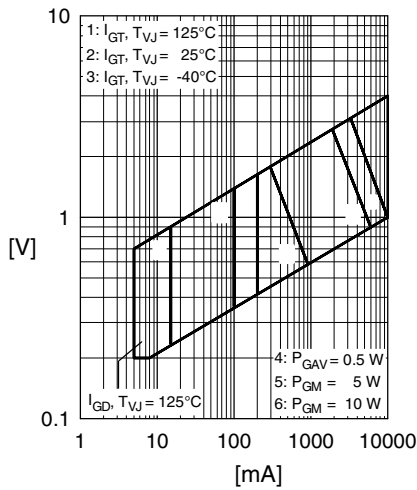

Fig. 4 Gate trigger characteristics

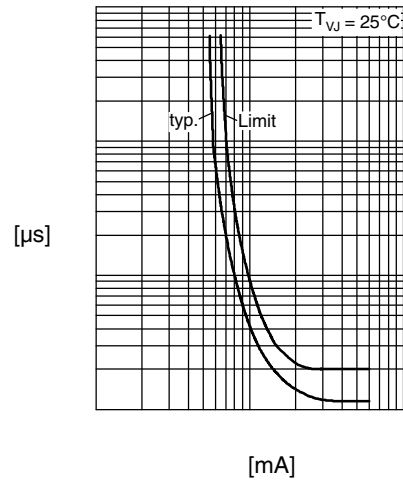

Fig. 5 Gate trigger delay time

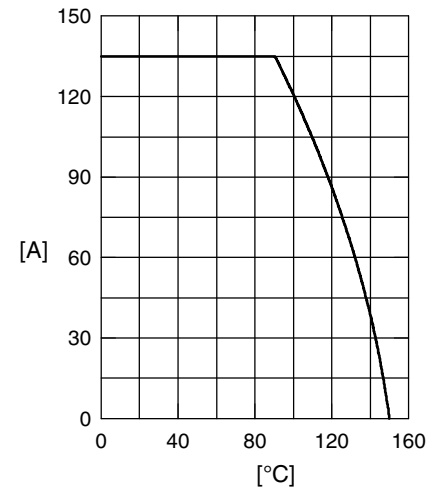

Fig. 6 Max. forward current versus case temperature

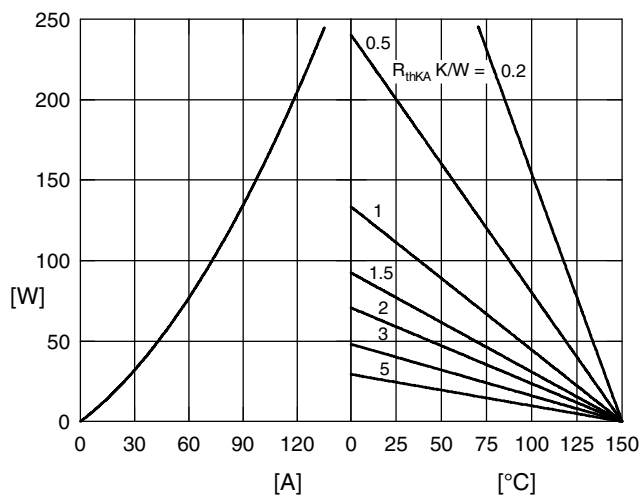

Fig.7 Power dissipation versus direct output current and ambient temperature, sine 180°

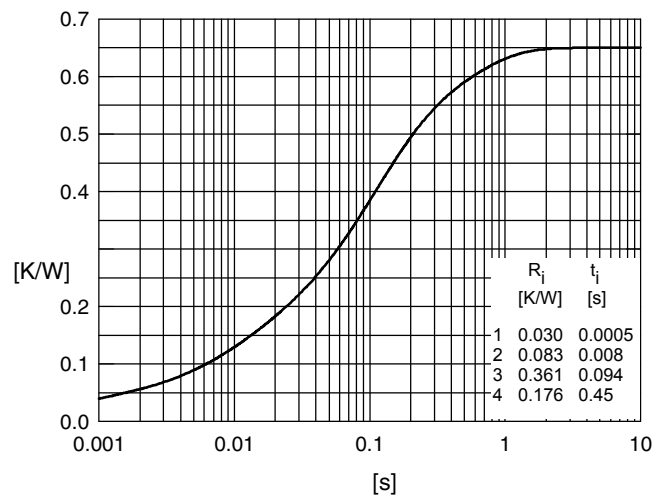

Fig. 8 Transient thermal impedance junction to case

Brake IGBT

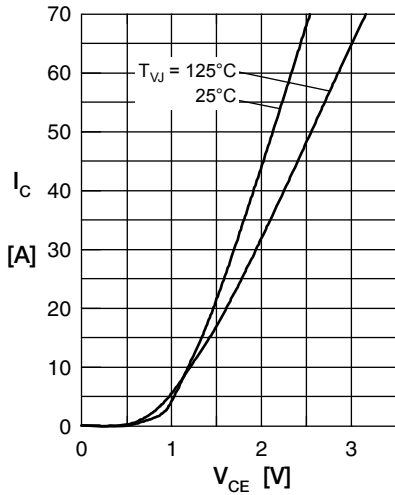

Fig. 1 Typ. output characteristics

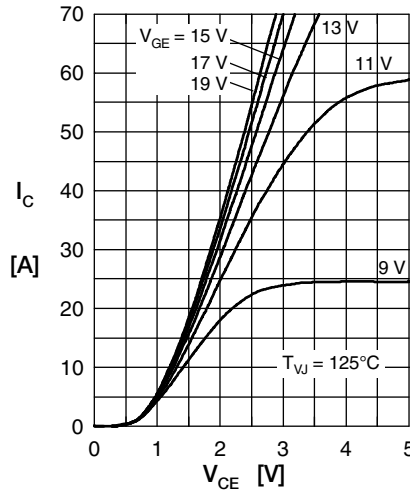

Fig. 2 Typ. output characteristics

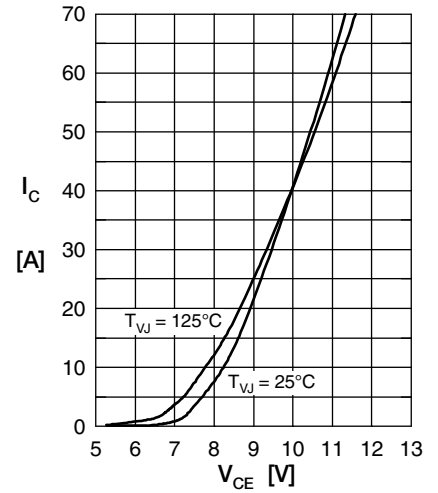

Fig. 3 Typ. transfer characteristics

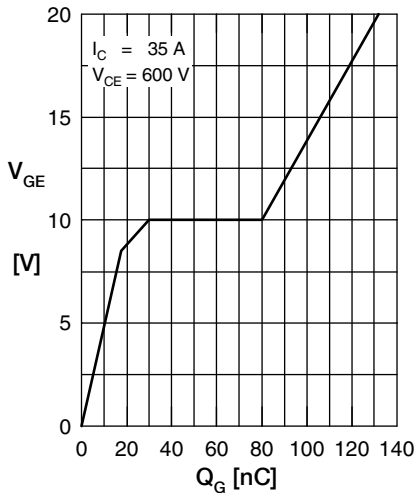

Fig. 4 Dynamic parameters Q_r , I_{RM} versus T_{VJ}

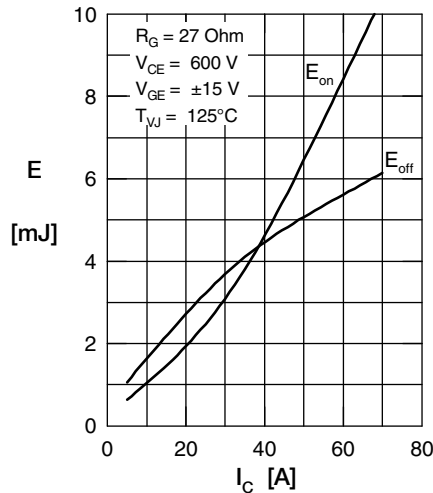

Fig. 5 Typ. recovery time t_{rr} versus $-di_F/dt$

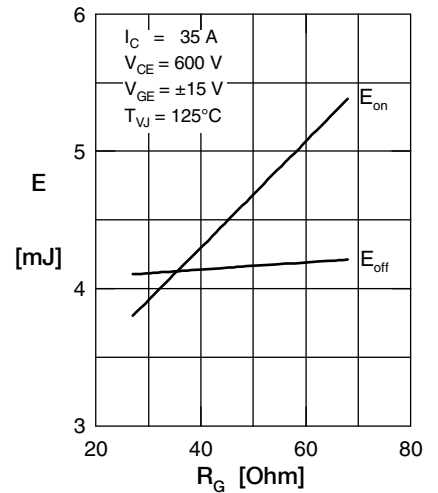

Fig. 6 Typ. peak forward voltage V_{FR} and t_{fr} versus di_F/dt

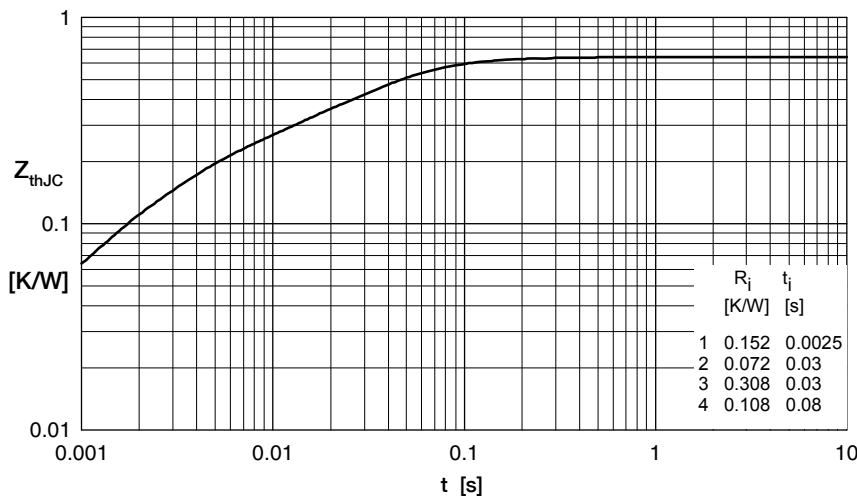

Fig. 7 Transient thermal impedance junction to case

Brake Diode

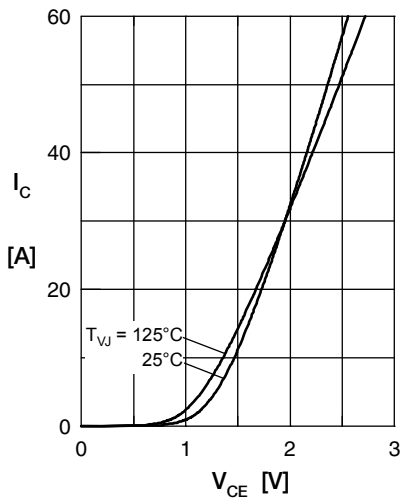

Fig. 1 Typ. Forward current versus V_{CE}

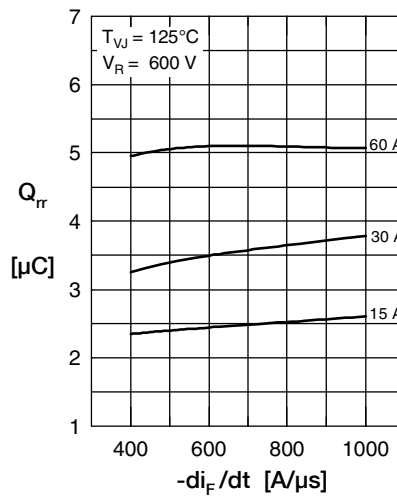

Fig. 2 Typ. reverse recovery charge Q_{rr} versus di/dt

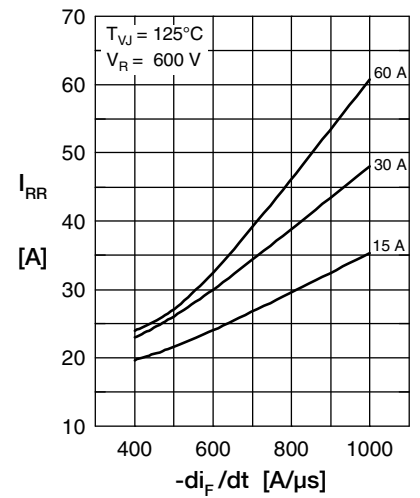

Fig. 3 Typ. peak reverse current I_{RM} versus di/dt

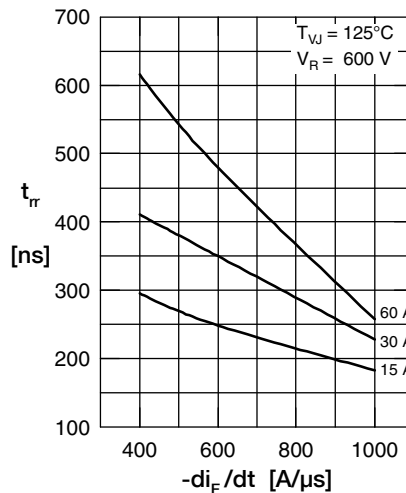

Fig. 4 Dynamic parameters Q_{rr} , I_{RM} versus T_{WJ}

Fig. 5 Typ. recovery time t_{rr} versus $-di_F/dt$

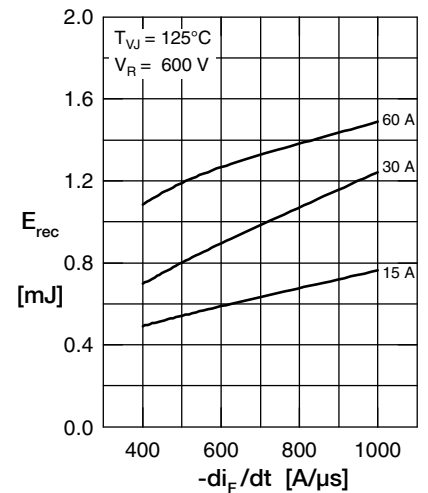

Fig. 6 Typ. recovery energy E_{rec} versus $-di/dt$

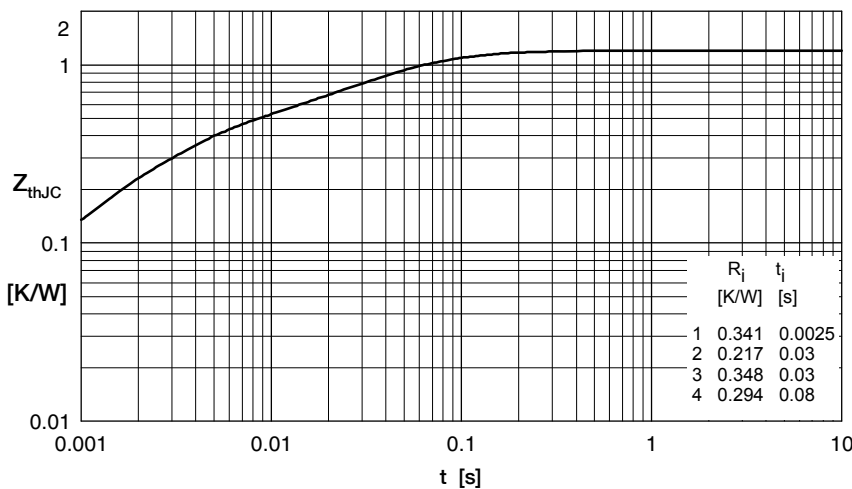

Fig. 7 Transient thermal impedance junction to case

Inverter IGBT

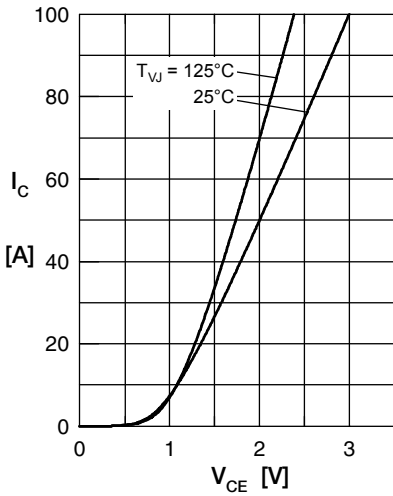

Fig. 1 Typ. output characteristics

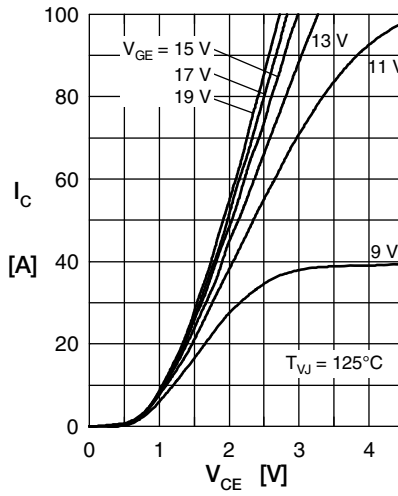

Fig. 2 Typ. output characteristics

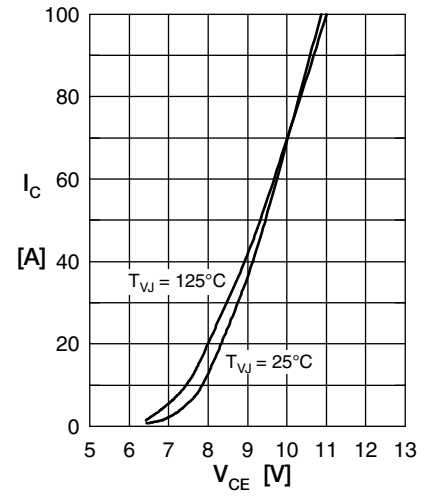

Fig. 3 Typ. transfer characteristics

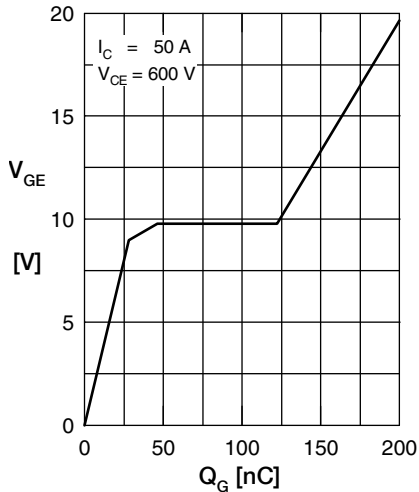

Fig. 4 Dynamic parameters Q_r, I_{RM} versus T_{VJ}

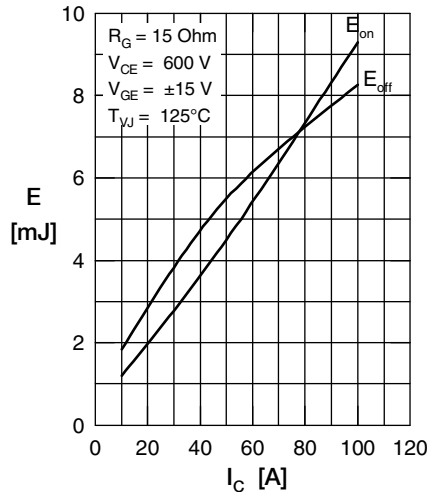

Fig. 5 Typ. recovery time t_{tr} versus $-di_F/dt$

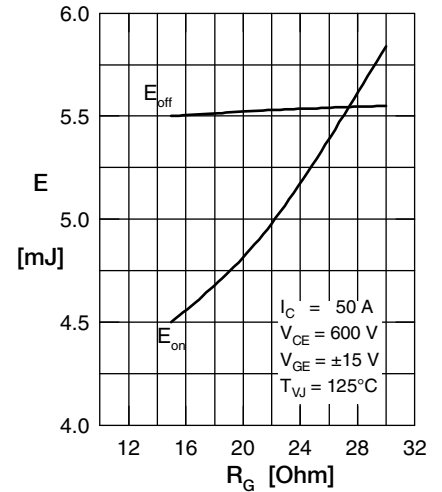

Fig. 6 Typ. peak forward voltage V_{FR} and t_{tr} versus di_F/dt

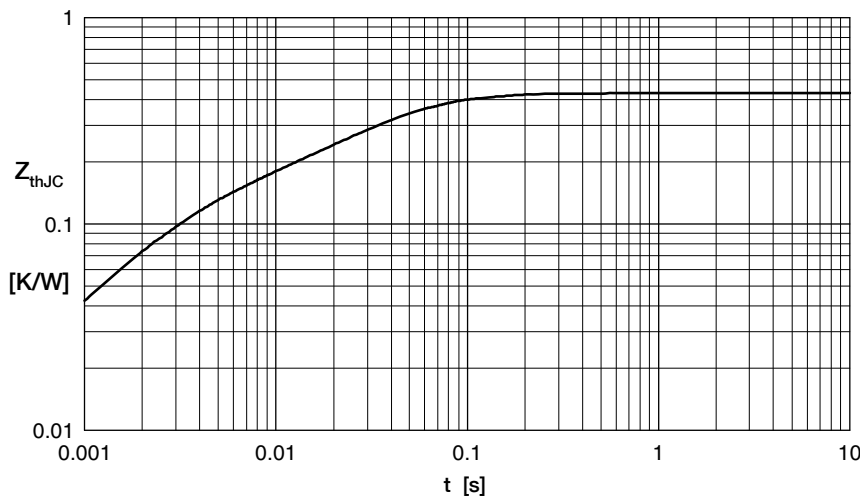

Fig. 7 Transient thermal impedance junction to case

Inverter Diode

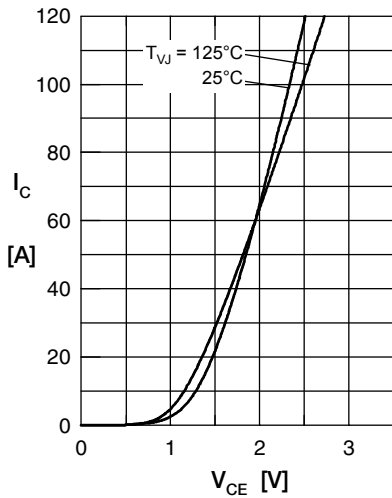

Fig. 1 Typ. Forward current versus V_F

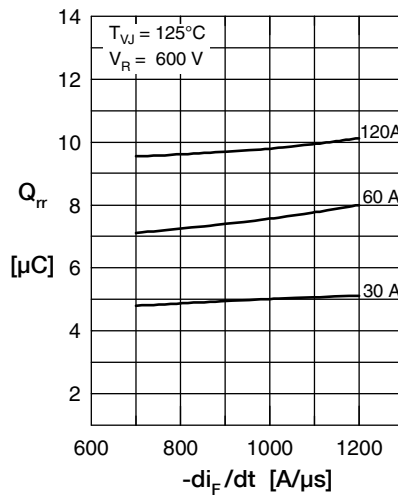

Fig. 2 Typ. reverse recovery charge Q_{rr} versus di/dt

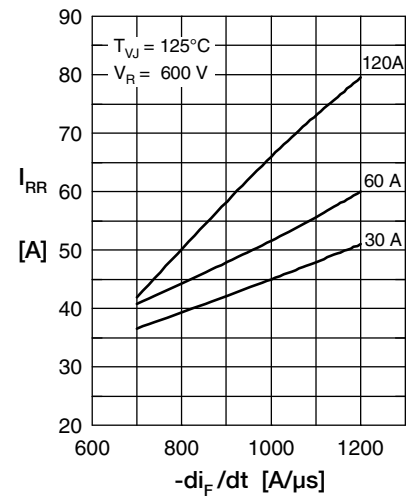

Fig. 3 Typ. peak reverse current I_{RM} versus di/dt

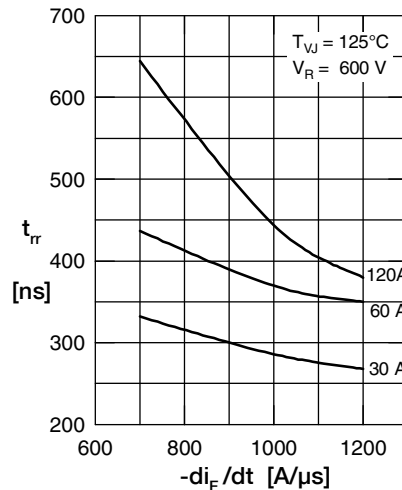

Fig. 4 Dynamic parameters Q_{rr} , I_{RM} versus T_{VJ}

Fig. 5 Typ. recovery time t_{rr} versus $-di_F/dt$

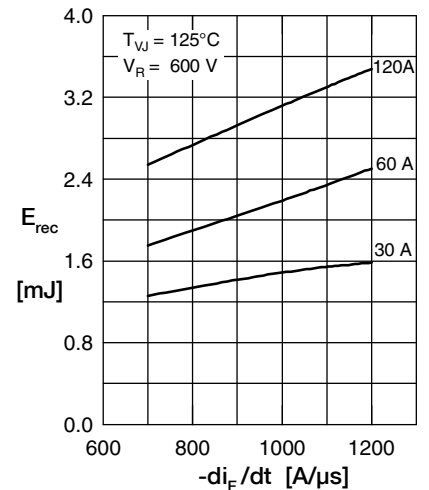

Fig. 6 Typ. recovery energy E_{rec} versus $-di/dt$

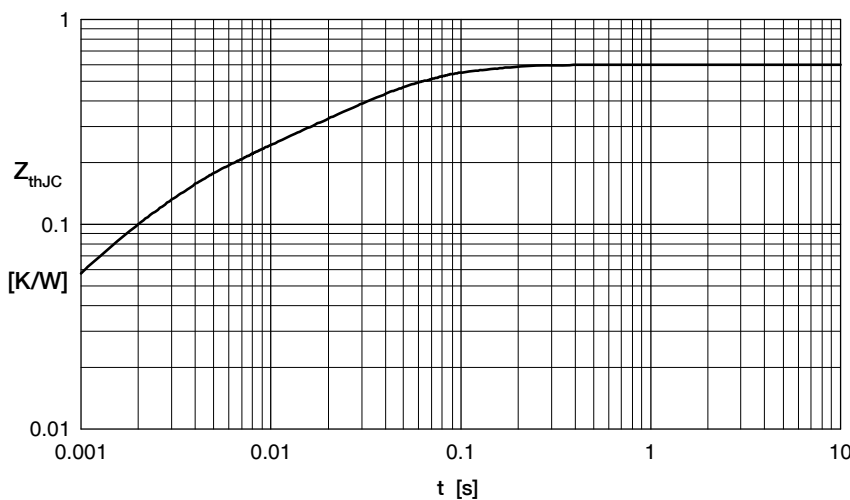

Fig. 7 Transient thermal impedance junction to case