



FWA020 Class II

20 Watt ITE Desktop Power Supply

- High Efficiency
- Fully Regulated DC Output
- 5-Year Limited Warranty
- Hold-up Time > 18ms at full load
- Safety Approval-EN60950-1 Class II
- Level V, EuP Directive Compliant
- LED Indicator

Overview

Over the later part of 2015, we will be changing the way we sell ITE power supplies through distribution to no longer include AC cords with the units. During this time of transition you find both versions available for sale. They can be distinguished by the part number, parts ending in -10B will include a cord in the box, parts ending in -10A will not include a cord. If your distributor has not already made a recommendation on a cord, please do not hesitate to ask us for assistance.

Elpac Part Number	Output Voltage	Output Current	Peak Current	Total Regulation	Typical Efficiency
FWA020005B-10B	5.0V	4.0A	4.8A	+/-5%	80%
FWA020005B-10A	5.0V	4.0A	4.8A	+/-5%	80%
FWA020009B-10B	9.0V	2.22A	2.6A	+/-5%	83%
FWA020009B-10A	9.0V	2.22A	2.6A	+/-5%	83%
FWA020012B-10B	12.0V	1.67A	2.0A	+/-5%	84%
FWA020012B-10A	12.0V	1.67A	2.0A	+/-5%	84%
FWA020024B-10A	24.0V	0.84A	1.0A	+/-5%	86%
FWA020012B-10B	24.0V	0.84A	1.0A	+/-5%	86%

Input

Input Voltage	85-264VAC; 100-240VAC Nominal
Input Frequency	47-63Hz
Input Current	<0.3A rms
Inrush Current	<50A @ 230VAC cold start
Zero Load Power Consumption	<0.3W
Earth Leakage Current (Typical)	<40 μ A @ 132VAC @ 60Hz (typical) <60 μ A @ 264VAC @ 60Hz (typical)

Output

Output Voltage	See Part Number Table
Total Regulation	+/-5%
Minimum Load	No minimum load required
Start-Up Delay	<1.5s
Hold-Up Time	>18ms at any input voltage
Ripple & Noise	<1% pk-pk**
Over Voltage Protection	112-135%
Over Temperature Protection	Active - Recoverable; plus Passive - Non Recoverable
Over Current Protection	108% - 160%
Short Circuit Protection	Shutdown, auto-restart (hiccup mode)

General

Efficiency	Avg Efficiency 83.4% at 115VAC; 82.8% @ 230VAC
MTBF	min. 200,000 hours demonstrated
Size	3.45" (87.7mm) x 2.04" (5.18mm) x 1.30" (33.0mm)
Weight	5V 0.4lbs (0.2Kg); 24V 0.3 lbs (0.16Kg)
Power Density	3.0 W/in ³

Environmental

Operating Temperature	0 – 60°C (Full load to 40°C, derate linearly to 50% load at 60°C)
Storage Temperature	-40°C to +85°C
Relative Humidity	5-95%, non-condensing
Cooling	Natural Convection
Vibration	All units production tested to 19.6m/s2

EMC & Safety

Emissions	FCC class B, CISPR22 class B EN61000-3-2, -3
Immunity	EN61000-4-2, -3, -4, -5, -6, -8, -11
Certified by TUV to the following:	cTUVus
	UL 60950-1
	CAN/CSA-22.2 No.950
	CB per IEC60950-1
	CE marked to LVD & EMC Directive

Input Configuration

Standard Input Cable	Not Provided
Connection on Power Supply Body	IEC 320 C8 Receptacle

Output Configuration

Standard Output Cable	6 ft.
Cord Size	16AWG zip (5V, 9V) 18AWG zip (12V) 20AWG zip (24V)
Connector (PSU side)	Switchcraft 760 or equivalent
Mating Connector	Switchcraft 712A or equivalent

Output Pin Assignments



Center

+v1

Outside

Return

5V and 9V Model

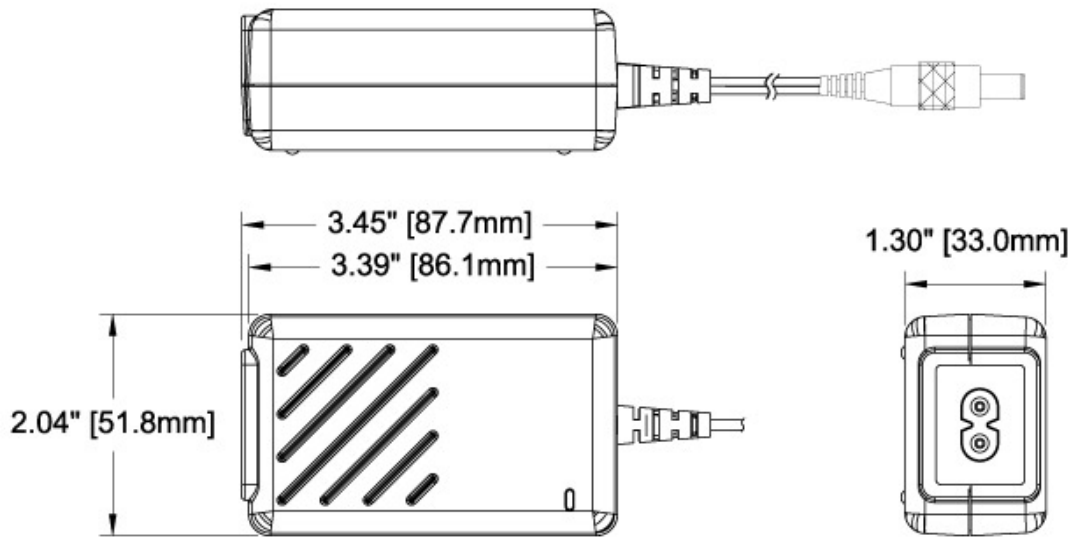

12V and 24V Model

