

RF LDMOS Wideband Integrated Power Amplifiers

The MW7IC18100N wideband integrated circuit is designed with on-chip matching that makes it usable from 1805 to 2050 MHz. This multi-stage structure is rated for 24 to 32 Volt operation and covers all typical cellular base station modulations including GSM EDGE and CDMA.

Final Application

- Typical GSM Performance: $V_{DD} = 28$ Volts, $I_{DQ1} = 180$ mA, $I_{DQ2} = 1000$ mA, $P_{out} = 100$ Watts CW, 1805-1880 MHz or 1930-1990 MHz
Power Gain — 30 dB
Power Added Efficiency — 48%

GSM EDGE Application

- Typical GSM EDGE Performance: $V_{DD} = 28$ Volts, $I_{DQ1} = 215$ mA, $I_{DQ2} = 800$ mA, $P_{out} = 40$ Watts Avg., 1805-1880 MHz or 1930-1990 MHz
Power Gain — 31 dB
Power Added Efficiency — 35%
Spectral Regrowth @ 400 kHz Offset = -63 dBc
Spectral Regrowth @ 600 kHz Offset = -80 dBc
EVM — 1.5% rms
- Capable of Handling 5:1 VSWR, @ 28 Vdc, 1990 MHz, 100 Watts CW Output Power
- Stable into a 5:1 VSWR. All Spurs Below -60 dBc @ 1 mW to 120 Watts CW P_{out} .

Features

- Characterized with Series Equivalent Large-Signal Impedance Parameters and Common Source Scattering Parameters
- On-Chip Matching (50 Ohm Input, DC Blocked)
- Integrated Quiescent Current Temperature Compensation with Enable/Disable Function (1)
- Integrated ESD Protection
- 225°C Capable Plastic Package
- RoHS Compliant
- In Tape and Reel. R1 Suffix = 500 Units per 44 mm, 13 inch Reel.

MW7IC18100NR1
MW7IC18100GNR1
MW7IC18100NBR1

1990 MHz, 100 W, 28 V
GSM/GSM EDGE
RF LDMOS WIDEBAND
INTEGRATED POWER AMPLIFIERS

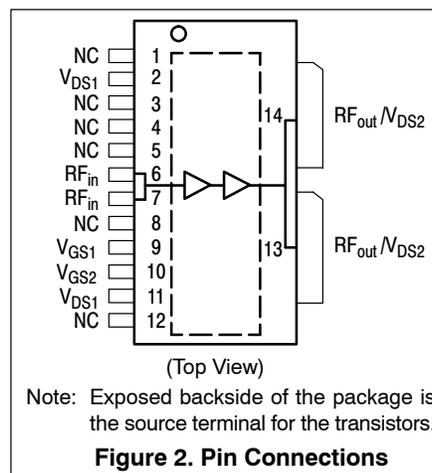
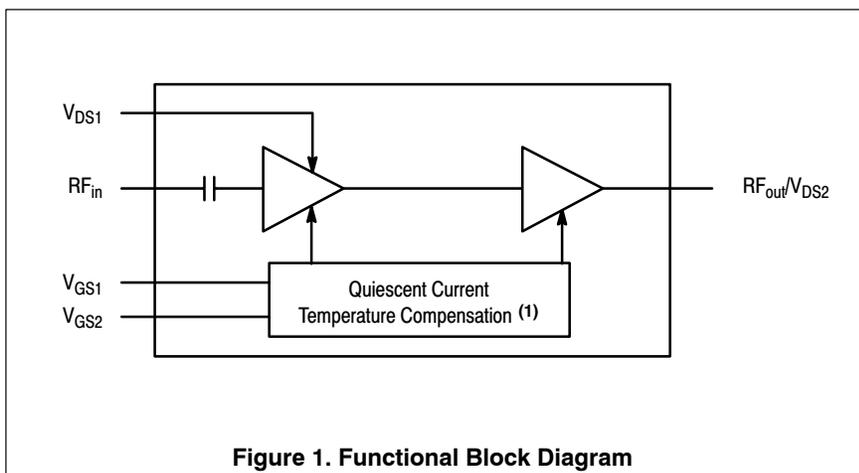
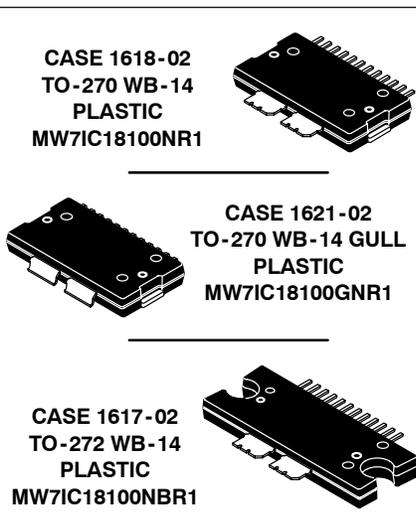

1. Refer to AN1977, Quiescent Current Thermal Tracking Circuit in the RF Integrated Circuit Family and to AN1987, Quiescent Current Control for the RF Integrated Circuit Device Family. Go to <http://www.freescale.com/rf>. Select Documentation/Application Notes - AN1977 or AN1987.

Table 1. Maximum Ratings

Rating	Symbol	Value	Unit
Drain-Source Voltage	V_{DSS}	-0.5, +65	Vdc
Gate-Source Voltage	V_{GS}	-0.5, +6	Vdc
Storage Temperature Range	T_{stg}	-65 to +150	°C
Case Operating Temperature	T_C	150	°C
Operating Junction Temperature (1,2)	T_J	225	°C

Table 2. Thermal Characteristics

Characteristic	Symbol	Value (2,3)	Unit
Thermal Resistance, Junction to Case GSM Application ($P_{out} = 100$ W CW)	$R_{\theta JC}$	2.0 0.51	°C/W
		Stage 1, 28 Vdc, $I_{DQ1} = 180$ mA Stage 2, 28 Vdc, $I_{DQ2} = 1000$ mA	

Table 3. ESD Protection Characteristics

Test Methodology	Class
Human Body Model (per JESD22-A114)	1 (Minimum)
Machine Model (per EIA/JESD22-A115)	A (Minimum)
Charge Device Model (per JESD22-C101)	III (Minimum)

Table 4. Moisture Sensitivity Level

Test Methodology	Rating	Package Peak Temperature	Unit
Per JESD 22-A113, IPC/JEDEC J-STD-020	3	260	°C

Table 5. Electrical Characteristics ($T_C = 25^\circ\text{C}$ unless otherwise noted)

Characteristic	Symbol	Min	Typ	Max	Unit
----------------	--------	-----	-----	-----	------

Functional Tests (4) (In Freescale Test Fixture, 50 ohm system) $V_{DD} = 28$ Vdc, $P_{out} = 100$ W CW, $I_{DQ1} = 180$ mA, $I_{DQ2} = 1000$ mA, $f = 1990$ MHz.

Power Gain	G_{ps}	27	30	31	dB
Input Return Loss	IRL	—	-15	-10	dB
Power Added Efficiency	PAE	45	48	—	%
P_{out} @ 1 dB Compression Point, CW	P1dB	100	112	—	W

Typical GSM EDGE Performances (In Freescale GSM EDGE Test Fixture, 50 ohm system) $V_{DD} = 28$ Vdc, $I_{DQ1} = 215$ mA, $I_{DQ2} = 800$ mA, $P_{out} = 40$ W Avg., 1805-1880 MHz or 1930-1990 MHz EDGE Modulation.

Power Gain	G_{ps}	—	31	—	dB
Power Added Efficiency	PAE	—	35	—	%
Error Vector Magnitude	EVM	—	1.5	—	% rms
Spectral Regrowth at 400 kHz Offset	SR1	—	-63	—	dBc
Spectral Regrowth at 600 kHz Offset	SR2	—	-80	—	dBc

1. Continuous use at maximum temperature will affect MTTF.
2. MTTF calculator available at <http://www.freescale.com/rf>. Select Software & Tools/Development Tools/Calculators to access MTTF calculators by product.
3. Refer to AN1955, *Thermal Measurement Methodology of RF Power Amplifiers*. Go to <http://www.freescale.com/rf>. Select Documentation/Application Notes - AN1955.
4. Measurement made with device in straight lead configuration before any lead forming operation is applied.

(continued)

Table 5. Electrical Characteristics ($T_C = 25^\circ\text{C}$ unless otherwise noted) (continued)

Characteristic	Symbol	Min	Typ	Max	Unit
Typical Performances (In Freescale Test Fixture, 50 ohm system) $V_{DD} = 28 \text{ Vdc}$, $I_{DQ1} = 180 \text{ mA}$, $I_{DQ2} = 1000 \text{ mA}$, 1930-1990 MHz Bandwidth					
Gain Flatness in 60 MHz Bandwidth @ $P_{out} = 100 \text{ W CW}$	G_F	—	0.37	—	dB
Average Deviation from Linear Phase in 60 MHz Bandwidth @ $P_{out} = 100 \text{ W CW}$	Φ	—	0.502	—	$^\circ$
Average Group Delay @ $P_{out} = 100 \text{ W CW}$, $f = 1960 \text{ MHz}$	Delay	—	2.57	—	ns
Part-to-Part Insertion Phase Variation @ $P_{out} = 100 \text{ W CW}$, $f = 1960 \text{ MHz}$, Six Sigma Window	$\Delta\Phi$	—	63.65	—	$^\circ$
Gain Variation over Temperature (-30°C to +85°C)	ΔG	—	0.048	—	dB/ $^\circ\text{C}$
Output Power Variation over Temperature (-30°C to +85°C)	ΔP_{1dB}	—	0.004	—	dBm/ $^\circ\text{C}$

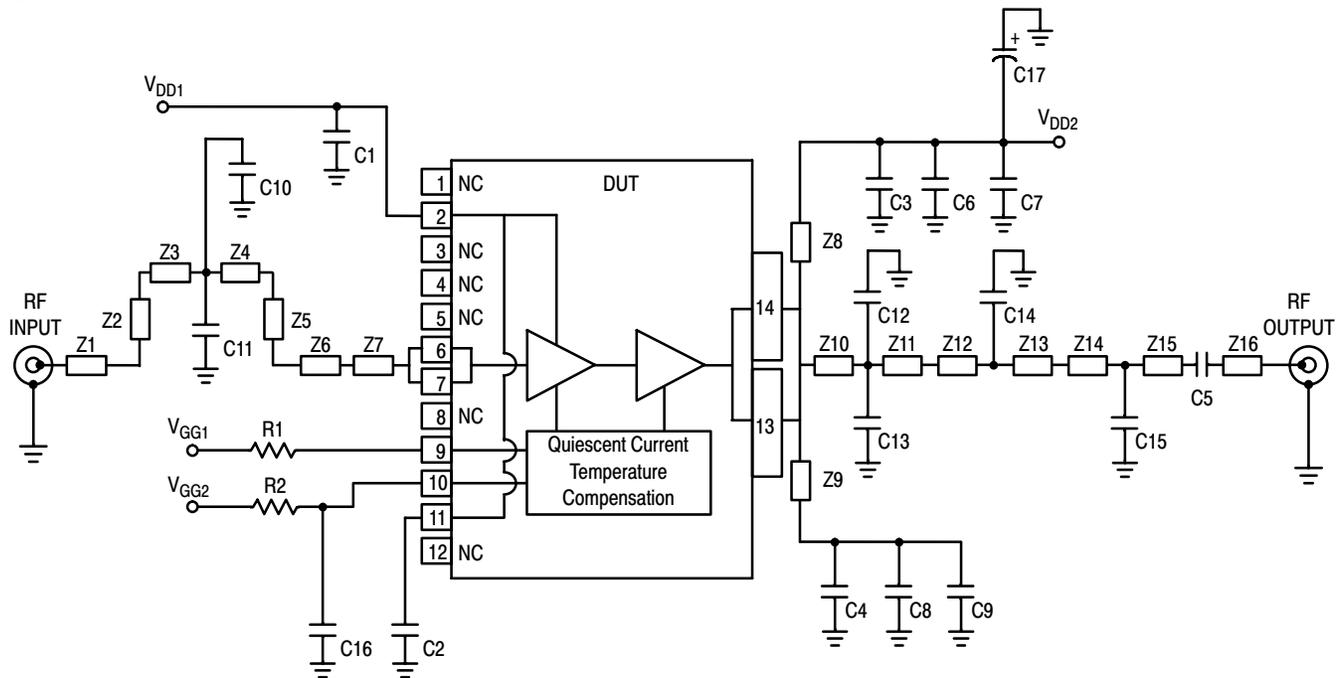

Z1	0.083" x 0.505" Microstrip	Z11	0.880" x 0.256" Microstrip
Z2, Z5	0.083" x 0.552" Microstrip	Z12	0.215" x 0.138" Microstrip
Z3	0.083" x 0.252" Microstrip	Z13	0.215" x 0.252" Microstrip
Z4	0.083" x 0.174" Microstrip	Z14	0.083" x 0.298" Microstrip
Z6	0.083" x 1.261" Microstrip	Z15	0.083" x 0.810" Microstrip
Z7	0.060" x 0.126" Microstrip	Z16	0.083" x 0.250" Microstrip
Z8, Z9	0.080" x 1.569" Microstrip	PCB	Arlon CuClad 250GX-0300-55-22, 0.030", $\epsilon_r = 2.55$
Z10	0.880" x 0.224" Microstrip		

Figure 3. MW7IC18100NR1(GNR1)(NBR1) Test Circuit Schematic — 1900 MHz

Table 6. MW7IC18100NR1(GNR1)(NBR1) Test Circuit Component Designations and Values — 1900 MHz

Part	Description	Part Number	Manufacturer
C1, C2, C3, C4, C5	6.8 pF Chip Capacitors	ATC100B6R8BT500XT	ATC
C6, C7, C8, C9	10 μ F, 50 V Chip Capacitors	GRM55DR61H106KA88L	Murata
C10, C11	0.2 pF Chip Capacitors	ATC100B0R2BT500XT	ATC
C12, C13	0.5 pF Chip Capacitors	ATC100B0R5BT500XT	ATC
C14	0.8 pF Chip Capacitor	ATC100B0R8BT500XT	ATC
C15	1.5 pF Chip Capacitor	ATC100B1R5BT500XT	ATC
C16	2.2 μ F, 16 V Chip Capacitor	C1206C225K4RAC	Kemet
C17	470 μ F, 63 V Electrolytic Capacitor, Radial	477KXM063M	Illinois Capacitor
R1, R2	10 K Ω , 1/4 W Chip Resistors	CRCW12061001FKEA	Vishay

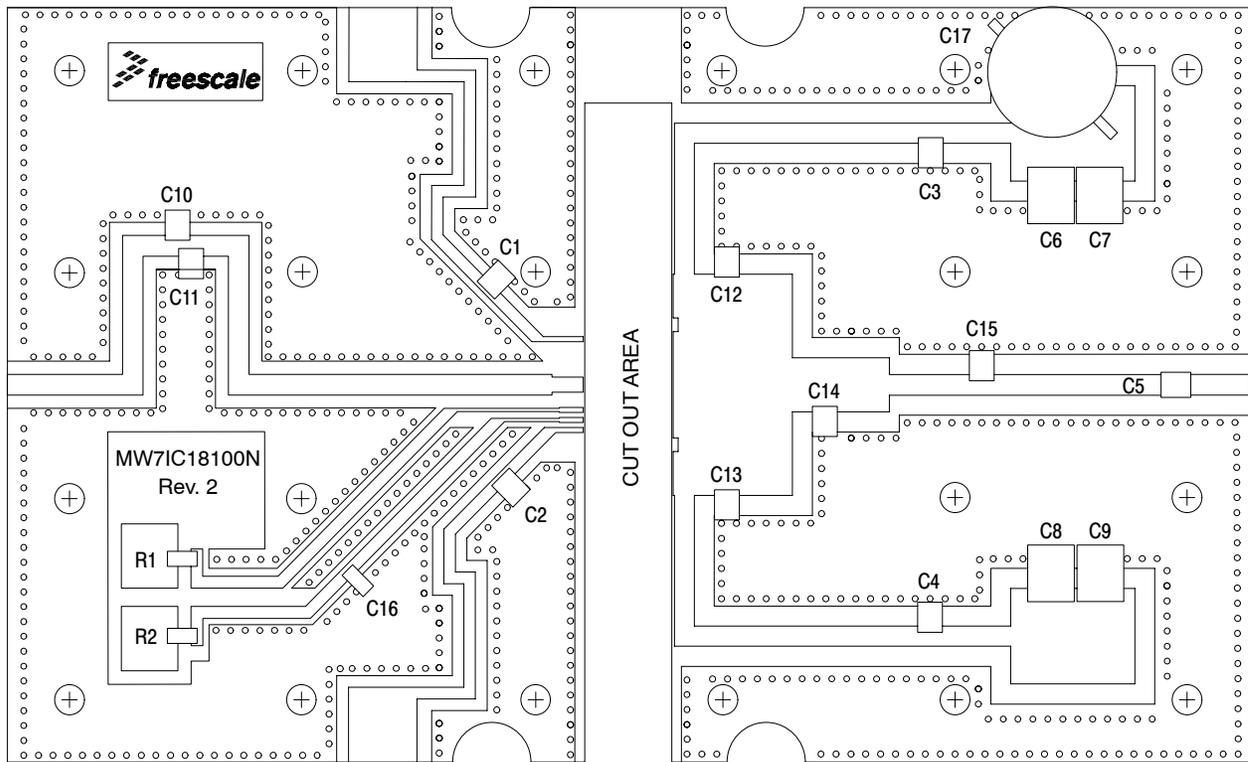

Figure 4. MW7IC18100NR1(GNR1)(NBR1) Test Circuit Component Layout — 1900 MHz

TYPICAL CHARACTERISTICS — 1900 MHz

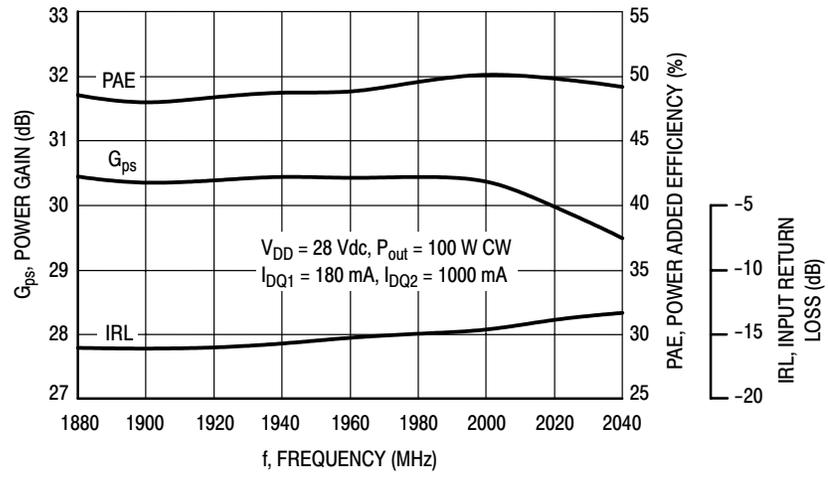

Figure 5. Power Gain, Input Return Loss and Power Added Efficiency versus Frequency @ $P_{out} = 100$ Watts CW

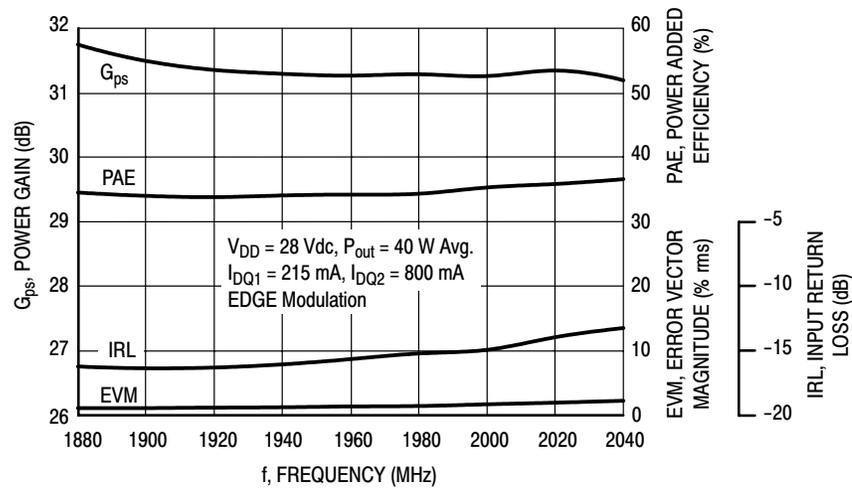

Figure 6. Power Gain, Input Return Loss, EVM and Power Added Efficiency versus Frequency @ $P_{out} = 40$ Watts Avg.

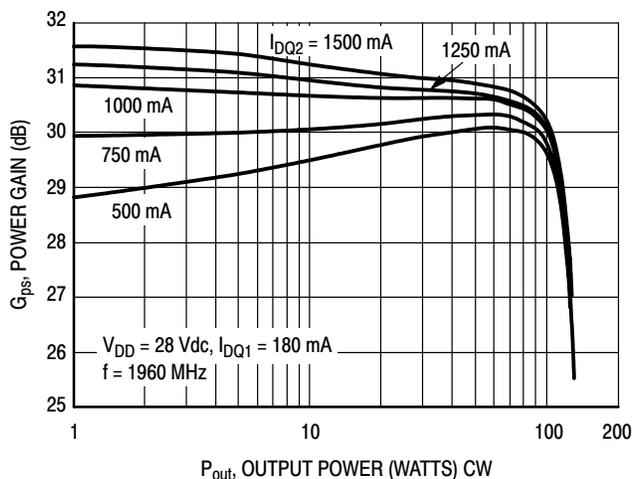

Figure 7. Two-Tone Power Gain versus Output Power @ $I_{DQ1} = 180$ mA

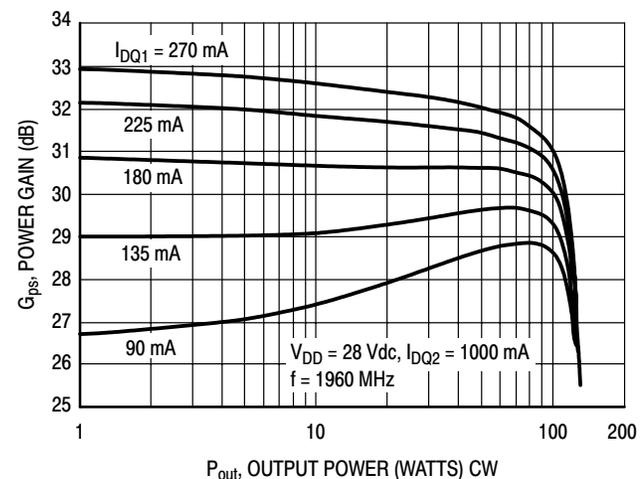

Figure 8. Two-Tone Power Gain versus Output Power @ $I_{DQ2} = 1000$ mA

TYPICAL CHARACTERISTICS — 1900 MHz

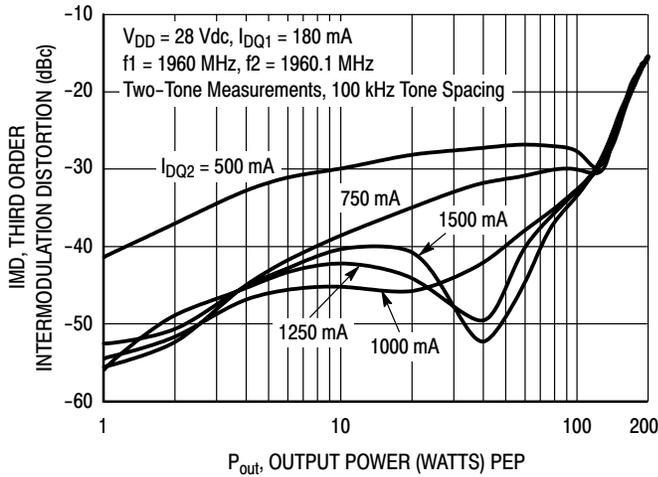

Figure 9. Third Order Intermodulation Distortion versus Output Power @ $I_{DQ1} = 180$ mA

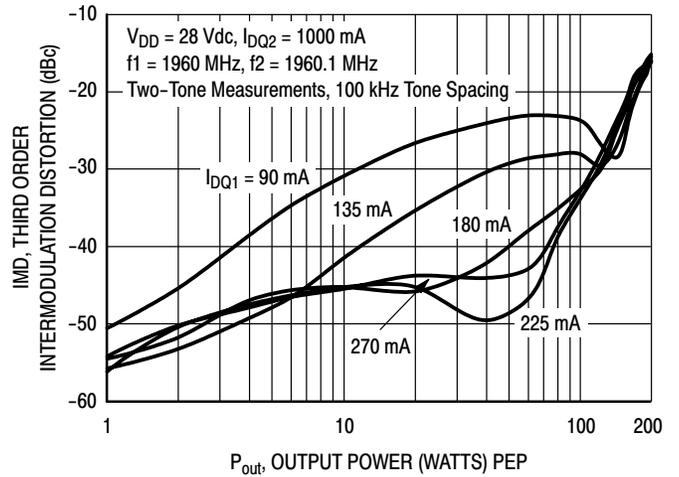

Figure 10. Third Order Intermodulation Distortion versus Output Power @ $I_{DQ2} = 1000$ mA

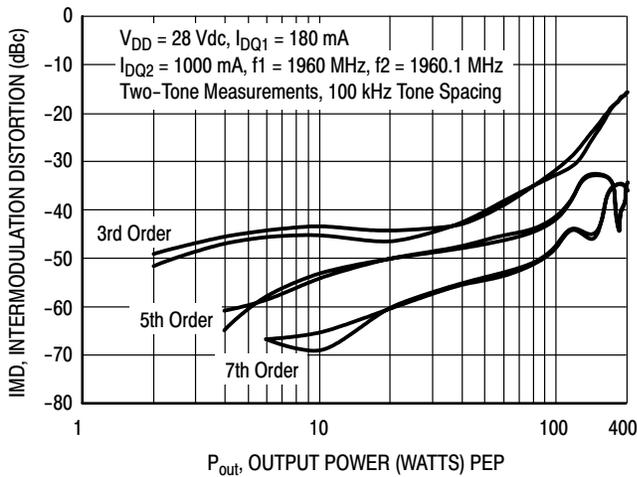

Figure 11. Intermodulation Distortion Products versus Output Power

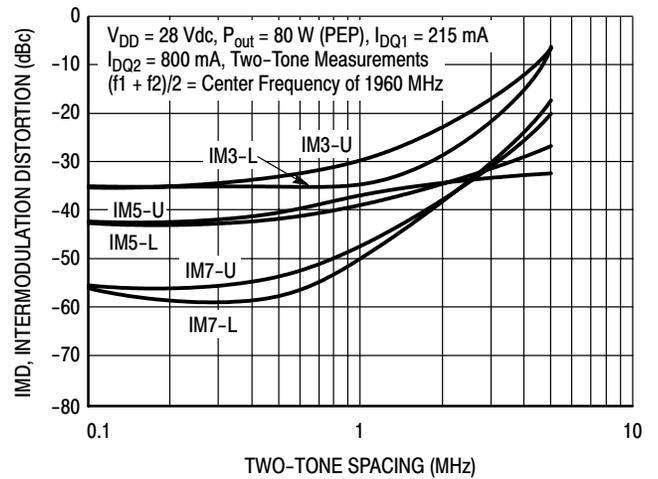

Figure 12. Intermodulation Distortion Products versus Tone Spacing

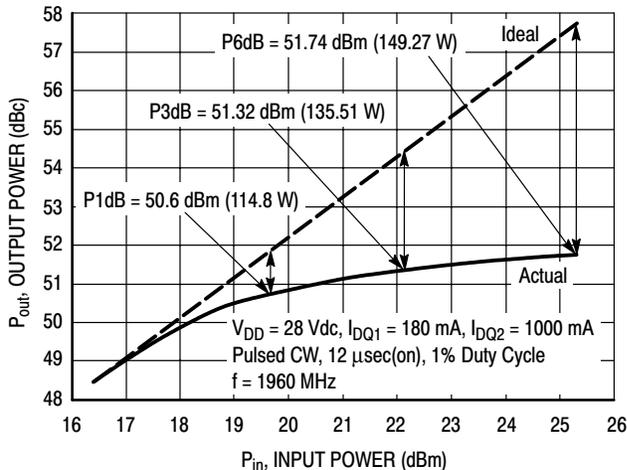

Figure 13. Pulsed CW Output Power versus Input Power

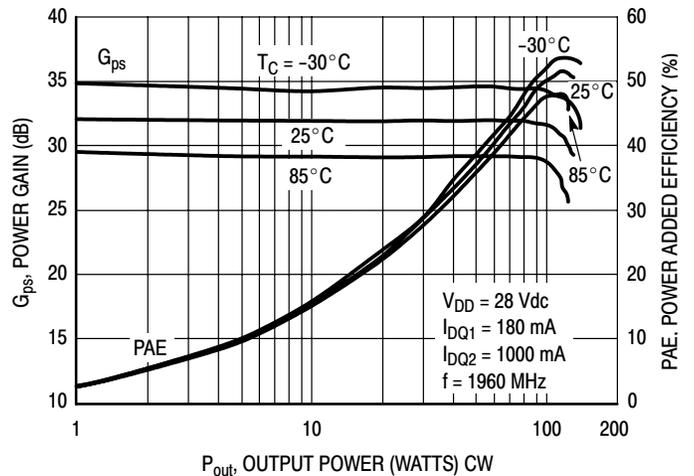

Figure 14. Power Gain and Power Added Efficiency versus Output Power

MW7IC18100NR1 MW7IC18100GMR1 MW7IC18100NBR1

TYPICAL CHARACTERISTICS — 1900 MHz

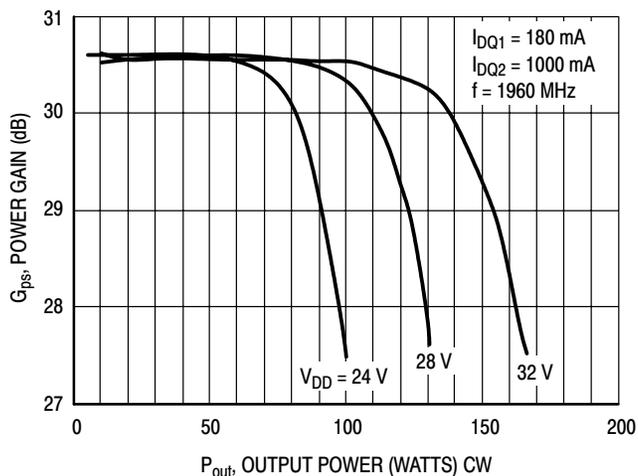

Figure 15. Power Gain versus Output Power

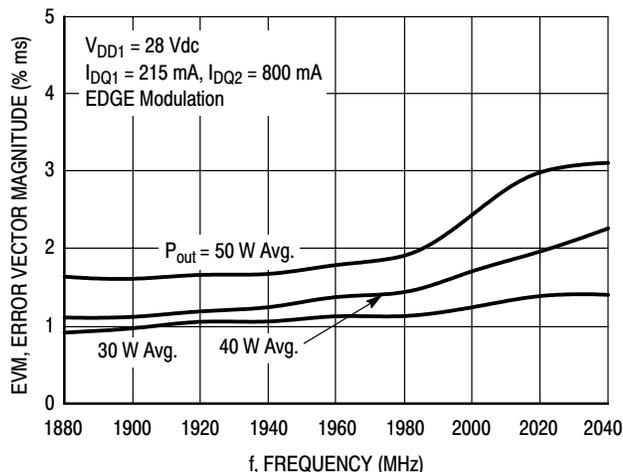

Figure 16. EVM versus Frequency

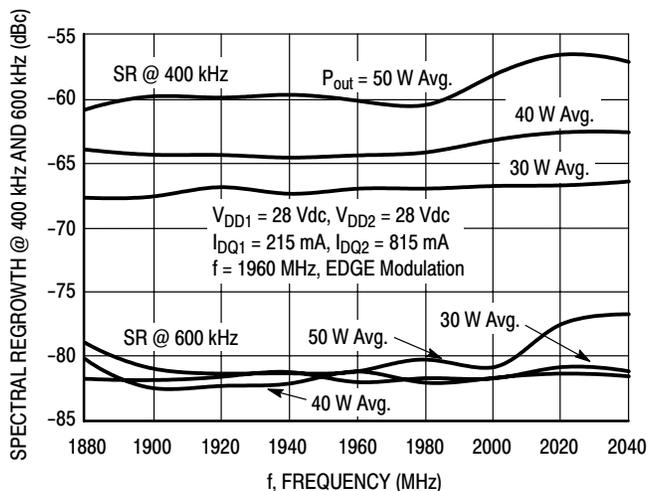

Figure 17. Spectral Regrowth at 400 kHz and 600 kHz versus Frequency

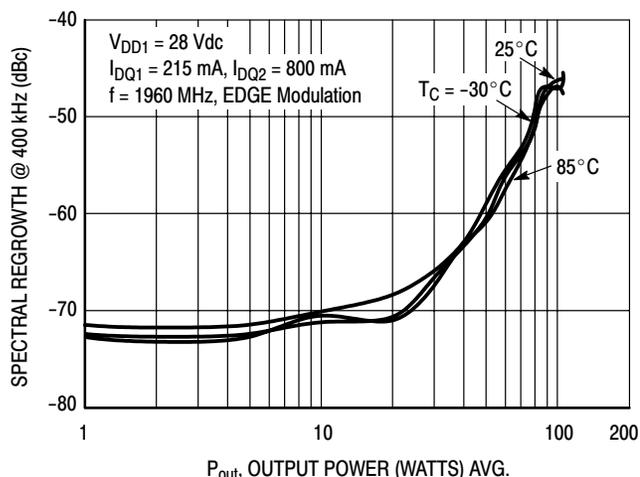

Figure 18. Spectral Regrowth at 400 kHz versus Output Power

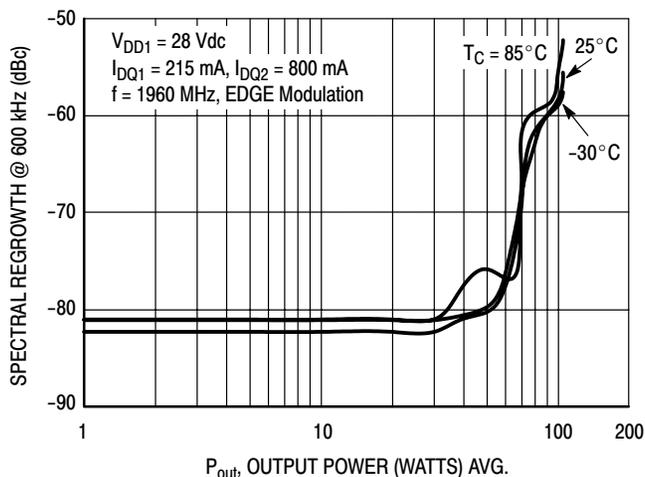

Figure 19. Spectral Regrowth at 600 kHz versus Output Power

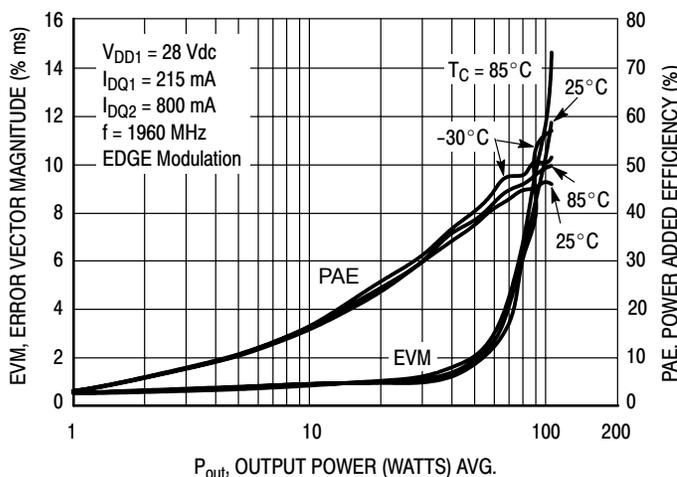

Figure 20. EVM and Power Added Efficiency versus Output Power

TYPICAL CHARACTERISTICS — 1900 MHz

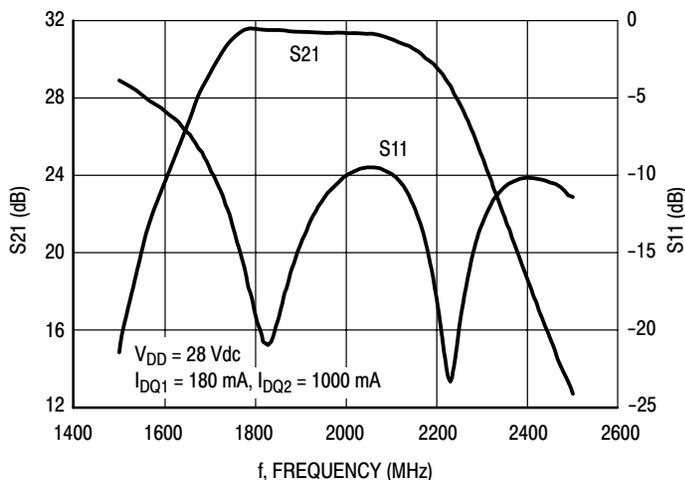

Figure 21. Broadband Frequency Response

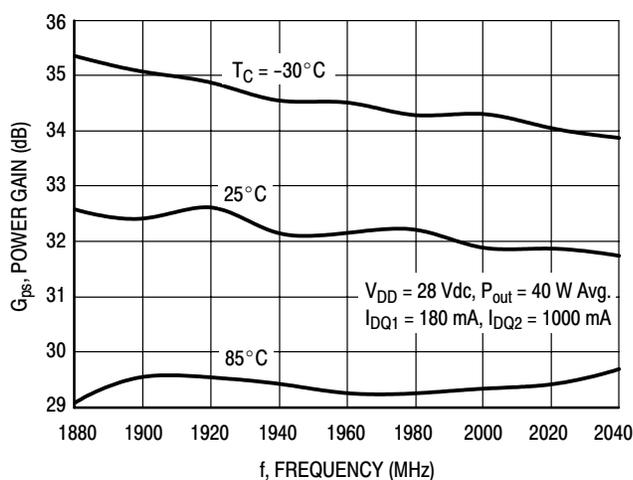
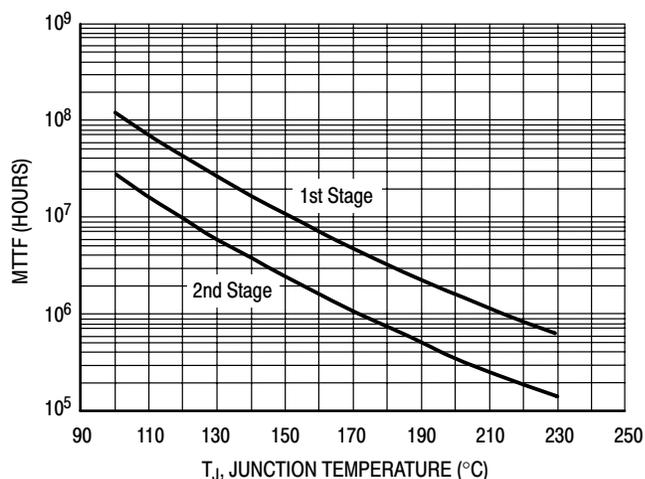

Figure 22. Power Gain versus Frequency



This above graph displays calculated MTTF in hours when the device is operated at $V_{DD} = 28$ Vdc, $P_{out} = 100$ W CW, and PAE = 48%.

MTTF calculator available at <http://www.freescale.com/rf>. Select Software & Tools/Development Tools/Calculators to access MTTF calculators by product.

Figure 23. MTTF versus Junction Temperature

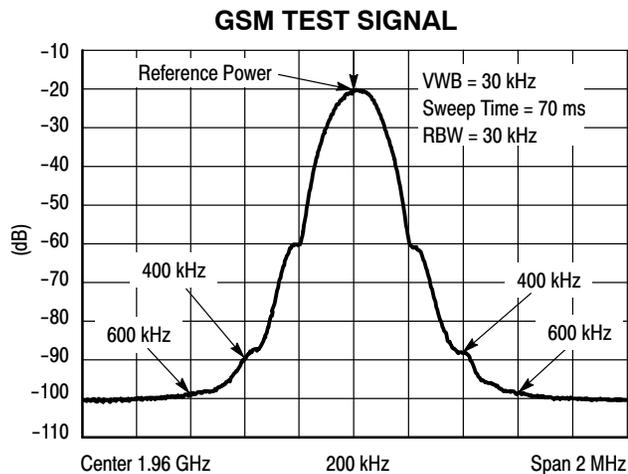
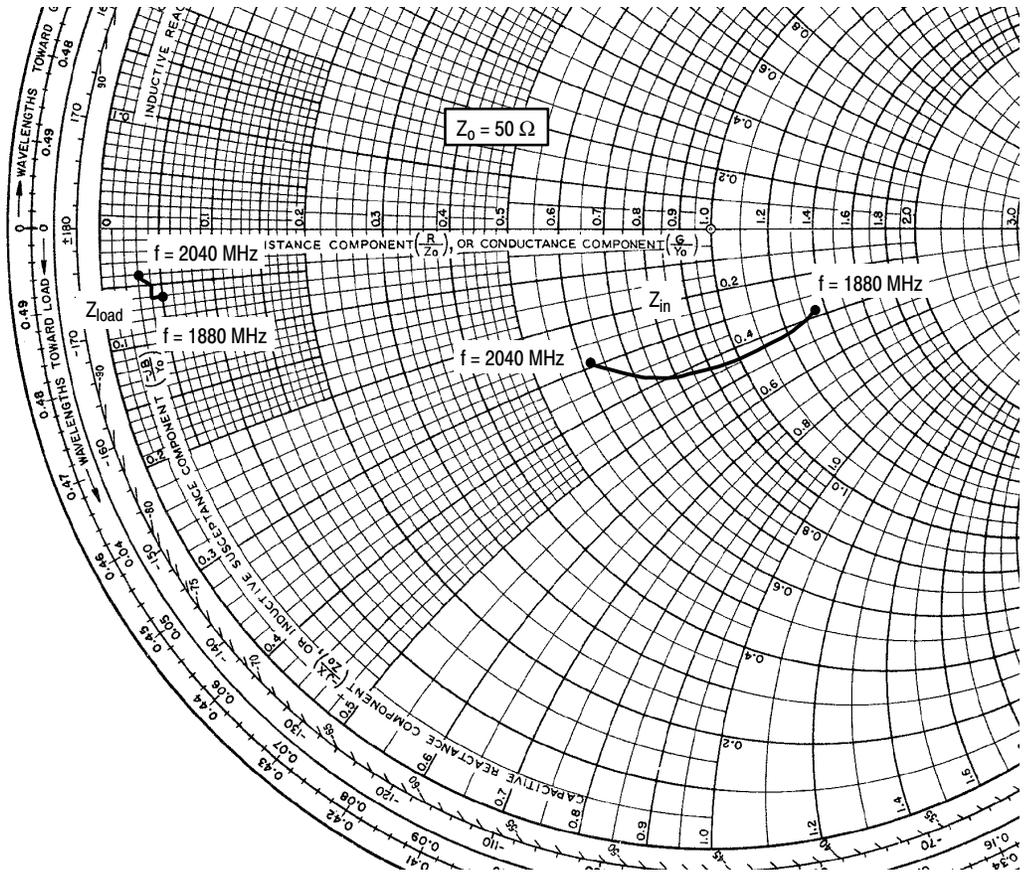

Figure 24. EDGE Spectrum



$V_{DD1} = V_{DD2} = 28 \text{ Vdc}$, $I_{DQ1} = 180 \text{ mA}$, $I_{DQ2} = 1000 \text{ mA}$, $P_{out} = 100 \text{ W CW}$

f MHz	Z_{in} Ω	Z_{load} Ω
1880	67.48 - j17.89	2.324 - j3.239
1900	60.03 - j20.86	2.234 - j3.105
1920	53.65 - j21.94	2.135 - j2.965
1940	48.13 - j21.94	2.037 - j2.818
1960	43.52 - j21.22	1.936 - j2.666
1980	39.60 - j20.00	1.851 - j2.509
2000	36.14 - j18.52	1.765 - j2.355
2020	33.19 - j16.57	1.669 - j2.193
2040	30.96 - j14.58	1.559 - j2.012

Z_{in} = Device input impedance as measured from gate to ground.

Z_{load} = Test circuit impedance as measured from drain to ground.

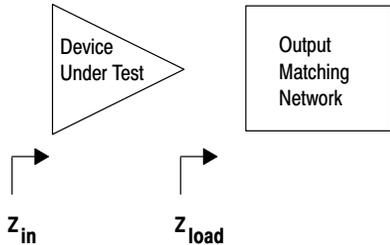
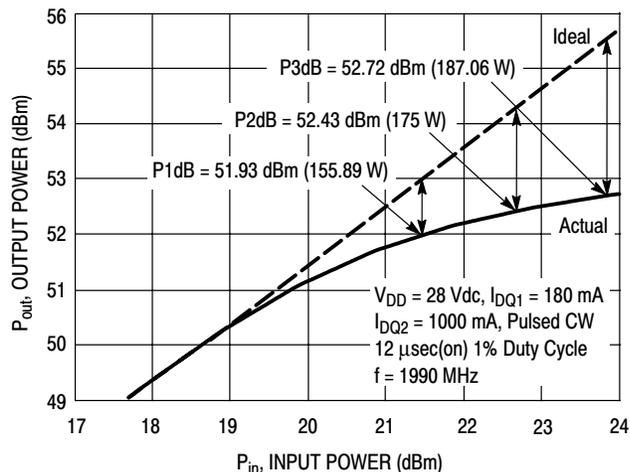

Figure 25. Series Equivalent Input and Load Impedance — 1900 MHz

Table 7. Common Source S-Parameters ($V_{DD} = 28\text{ V}$, $I_{DQ1} = 180\text{ mA}$, $I_{DQ2} = 1000\text{ mA}$, $T_C = 25^\circ\text{C}$, 50 Ohm System)

f MHz	S ₁₁		S ₂₁		S ₁₂		S ₂₂	
	S ₁₁	∠ φ	S ₂₁	∠ φ	S ₁₂	∠ φ	S ₂₂	∠ φ
1500	0.612	118.5	6.369	69.06	0.002	102.9	0.615	47.74
1550	0.557	104.3	11.42	18.29	0.003	85.09	0.666	-41.54
1600	0.491	88.33	16.92	-34.34	0.005	59.06	0.844	-113.4
1650	0.410	70.24	23.21	-84.03	0.005	28.40	0.931	-163.4
1700	0.313	48.99	30.49	-135.7	0.006	7.983	0.887	155.6
1750	0.216	21.99	32.64	168.8	0.007	-15.63	0.700	120.3
1800	0.131	-22.83	32.93	114.0	0.006	-35.27	0.475	95.71
1850	0.117	-95.13	32.62	65.01	0.006	-53.22	0.332	82.10
1900	0.185	-146.3	32.58	20.45	0.006	-77.03	0.252	68.30
1950	0.253	-177.3	32.45	-22.53	0.007	-98.93	0.165	47.02
2000	0.303	160.4	32.41	-65.29	0.007	-108.4	0.052	8.742
2050	0.328	139.5	32.33	-108.6	0.006	-127.3	0.070	-154.8
2100	0.331	117.9	32.50	-152.7	0.008	-145.8	0.161	179.9
2150	0.273	91.65	32.84	160.2	0.008	-169.1	0.257	165.7
2200	0.141	64.27	32.52	109.2	0.008	162.7	0.424	150.3
2250	0.050	172.7	28.92	56.72	0.009	138.3	0.641	123.4
2300	0.194	163.4	21.30	8.112	0.007	112.6	0.804	91.99
2350	0.270	139.7	14.62	-34.53	0.007	97.74	0.879	62.03
2400	0.288	118.9	9.878	-72.70	0.007	84.37	0.910	34.57
2450	0.274	100.6	6.771	-107.5	0.007	70.79	0.911	8.878
2500	0.236	83.35	4.579	-141.3	0.007	55.31	0.903	-16.73

ALTERNATIVE PEAK TUNE LOAD PULL CHARACTERISTICS — 1900 MHz



NOTE: Load Pull Test Fixture Tuned for Peak Output Power @ 28 V

Test Impedances per Compression Level

	Z_{source} Ω	Z_{load} Ω
P3dB	40.2 - j30.91	0.96 - j3.14

Figure 26. Pulsed CW Output Power versus Input Power @ 28 V

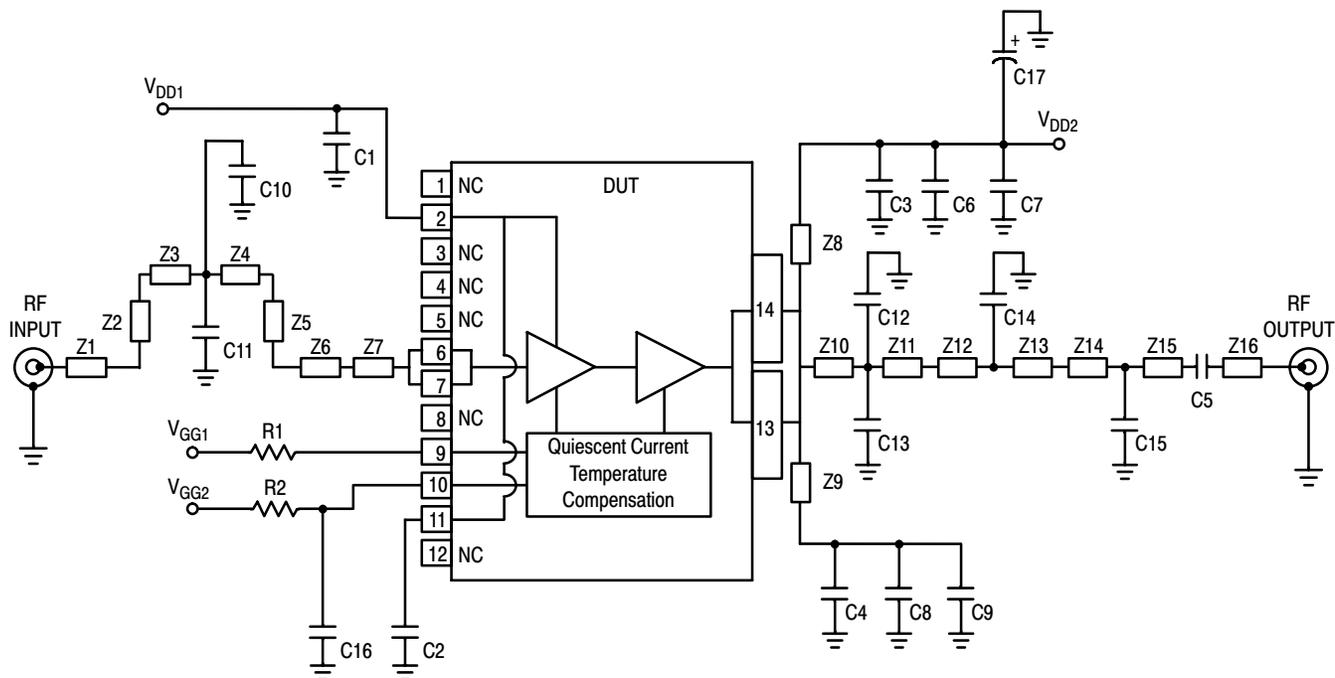

Z1	0.083" x 0.505" Microstrip	Z11	0.880" x 0.256" Microstrip
Z2, Z5	0.083" x 0.552" Microstrip	Z12	0.215" x 0.138" Microstrip
Z3	0.083" x 0.252" Microstrip	Z13	0.215" x 0.252" Microstrip
Z4	0.083" x 0.174" Microstrip	Z14	0.083" x 0.298" Microstrip
Z6	0.083" x 1.261" Microstrip	Z15	0.083" x 0.810" Microstrip
Z7	0.060" x 0.126" Microstrip	Z16	0.083" x 0.250" Microstrip
Z8, Z9	0.080" x 1.569" Microstrip	PCB	Arlon CuClad 250GX-0300-55-22, 0.030", $\epsilon_r = 2.55$
Z10	0.880" x 0.224" Microstrip		

Figure 27. MW7IC18100NR1(GNR1)(NBR1) Test Circuit Schematic — 1800 MHz

Table 8. MW7IC18100NR1(GNR1)(NBR1) Test Circuit Component Designations and Values — 1800 MHz

Part	Description	Part Number	Manufacturer
C1, C2, C3, C4, C5	6.8 pF Chip Capacitors	ATC100B6R8BT500XT	ATC
C6, C7, C8, C9	10 μ F, 50 V Chip Capacitors	GRM55DR61H106KA88L	Murata
C10, C11	0.2 pF Chip Capacitors	ATC100B0R2BT500XT	ATC
C12, C13	0.8 pF Chip Capacitors	ATC100B0R8BT500XT	ATC
C14	1.2 pF Chip Capacitor	ATC100B1R2BT500XT	ATC
C15	1.0 pF Chip Capacitor	ATC100B1R0BT500XT	ATC
C16	2.2 μ F, 16 V Chip Capacitor	C1206C225K4RAC	Kemet
C17	470 μ F, 63 V Electrolytic Capacitor, Radial	477KXM063M	Illinois Capacitor
R1, R2	10 K Ω , 1/4 W Chip Resistors	CRCW12061001FKEA	Vishay

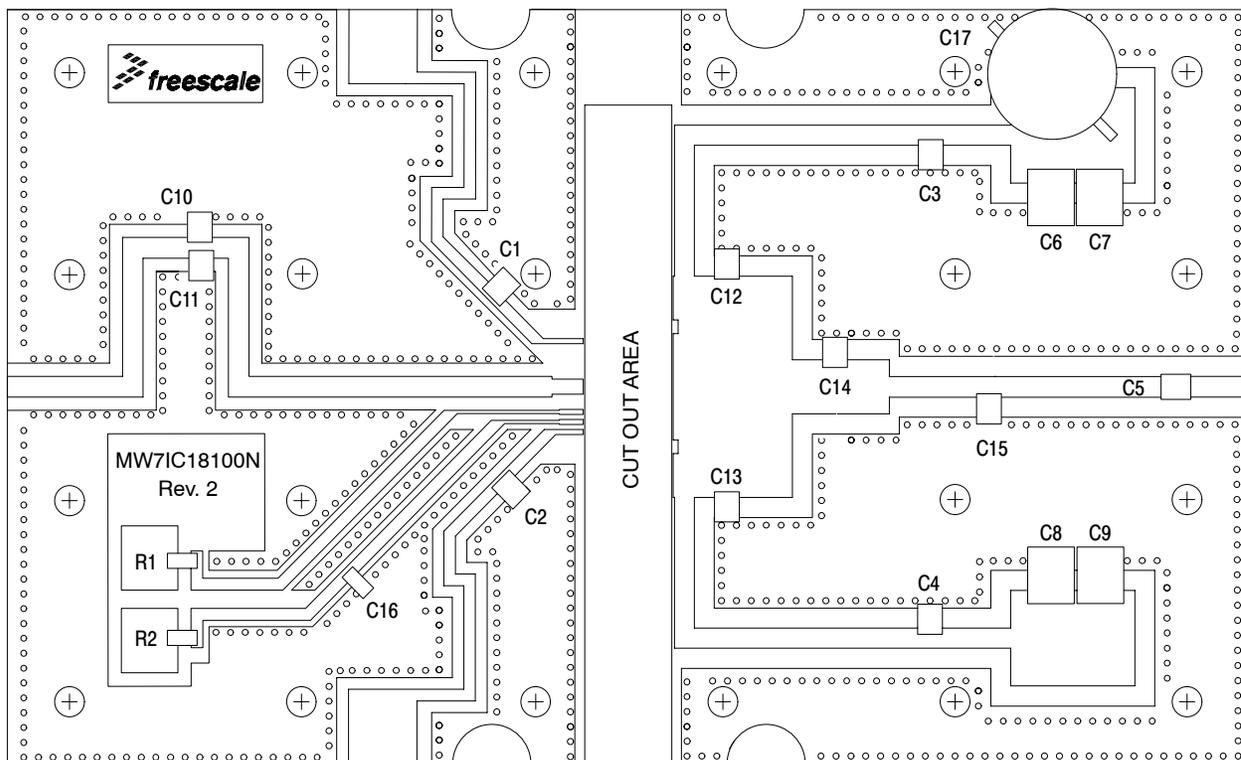

Figure 28. MW7IC18100NR1(GNR1)(NBR1) Test Circuit Component Layout — 1800 MHz

TYPICAL CHARACTERISTICS — 1800 MHz

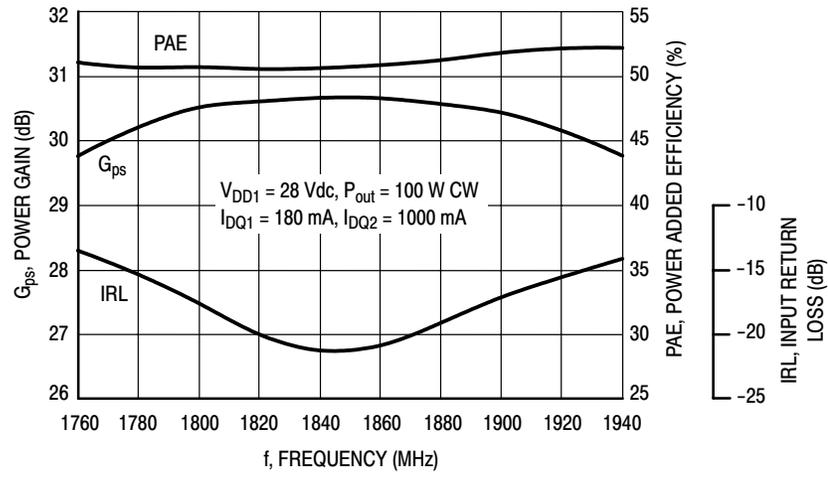

Figure 29. Power Gain, Input Return Loss and Power Added Efficiency versus Frequency @ $P_{out} = 100$ Watts CW

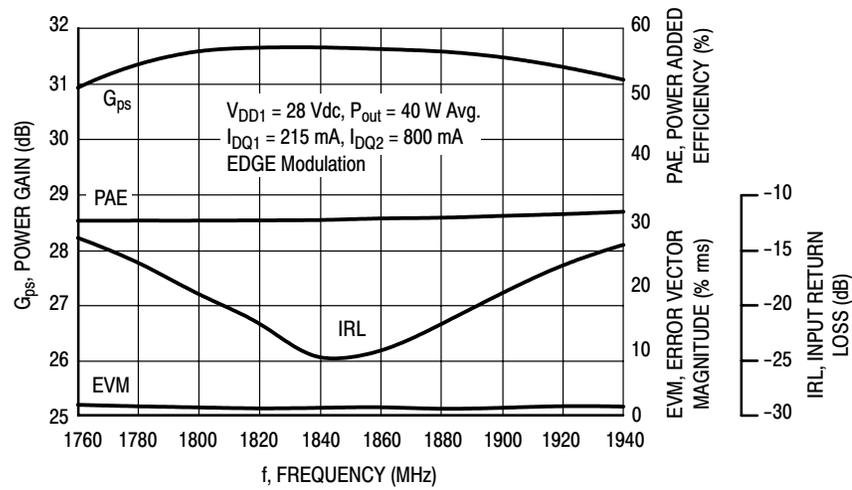

Figure 30. Power Gain, Input Return Loss, EVM and Power Added Efficiency versus Frequency @ $P_{out} = 40$ Watts Avg.

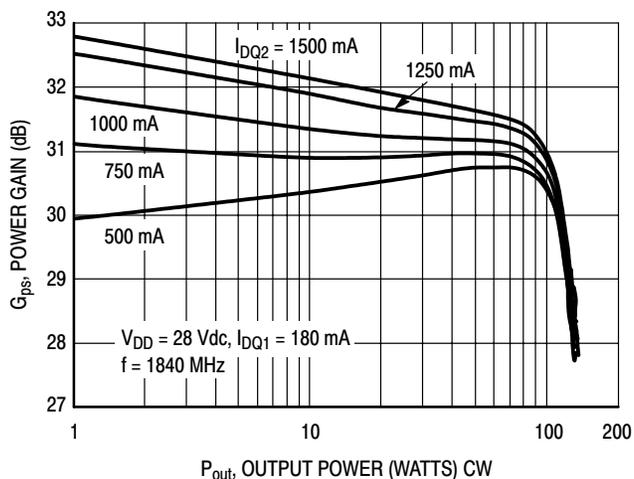

Figure 31. Two-Tone Power Gain versus Output Power @ $I_{DQ1} = 180 \text{ mA}$

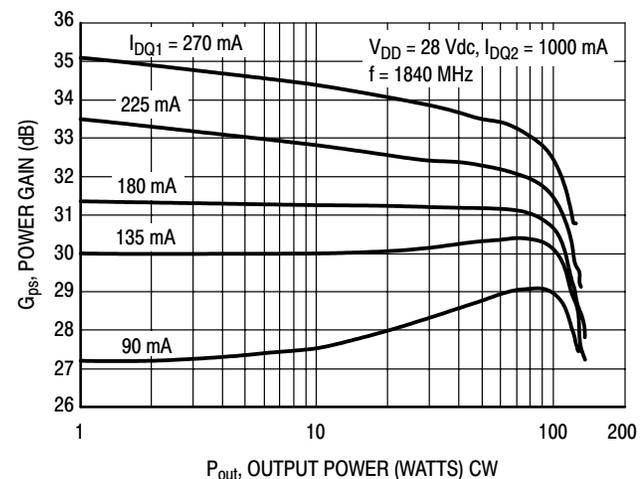

Figure 32. Two-Tone Power Gain versus Output Power @ $I_{DQ2} = 1000 \text{ mA}$

TYPICAL CHARACTERISTICS — 1800 MHz

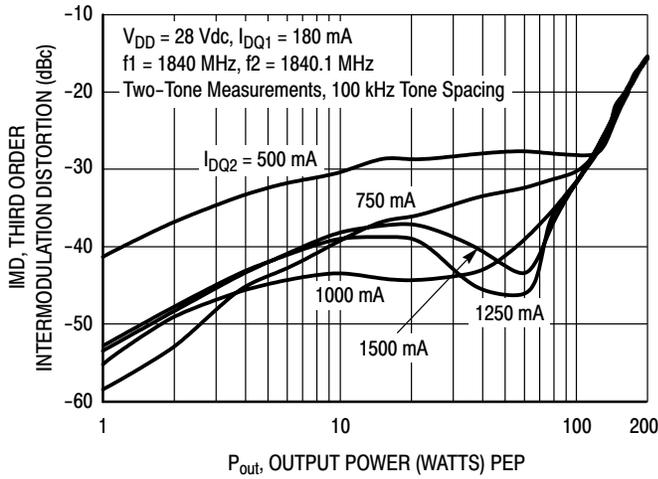

Figure 33. Third Order Intermodulation Distortion versus Output Power @ $I_{DQ1} = 180$ mA

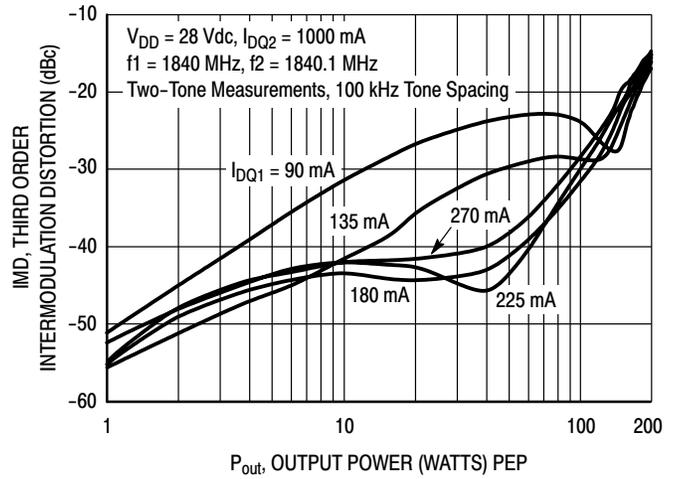

Figure 34. Third Order Intermodulation Distortion versus Output Power @ $I_{DQ2} = 1000$ mA

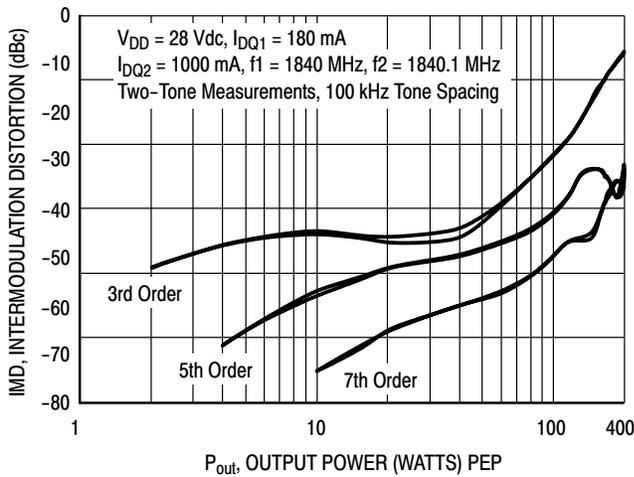

Figure 35. Intermodulation Distortion Products versus Output Power

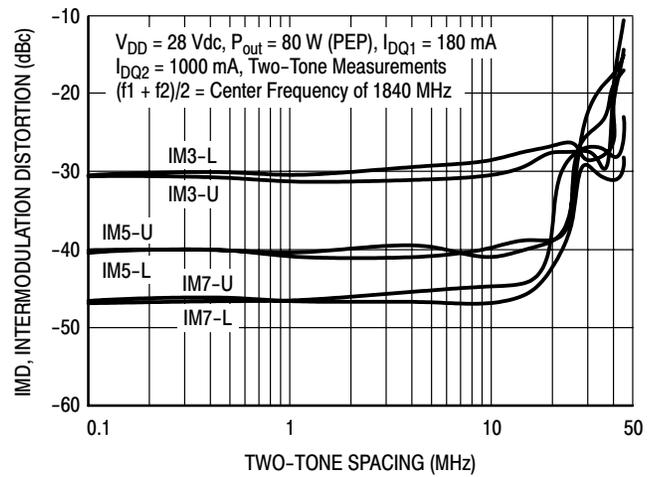

Figure 36. Intermodulation Distortion Products versus Tone Spacing

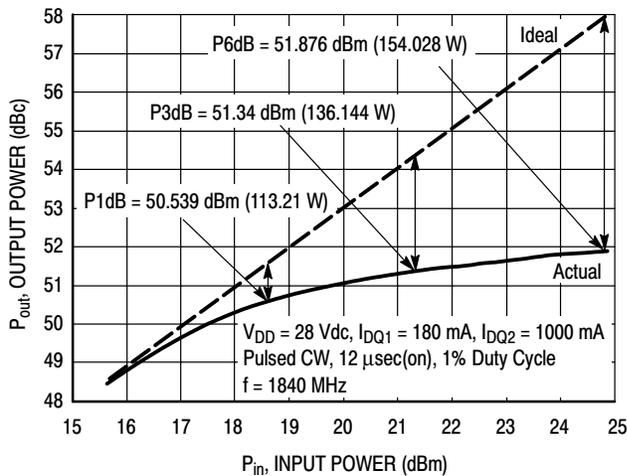

Figure 37. Pulsed CW Output Power versus Input Power

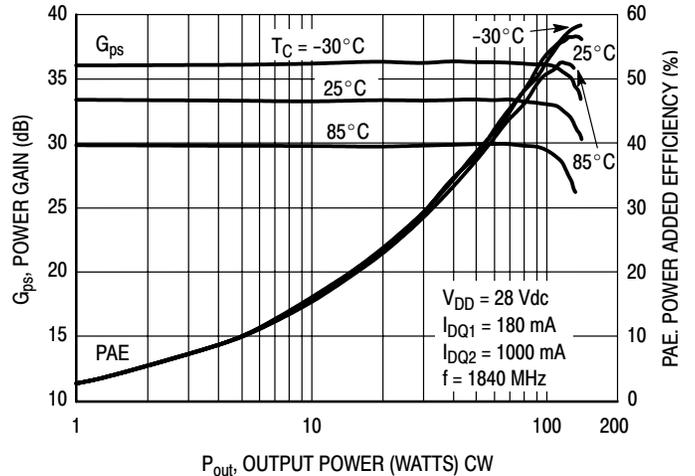

Figure 38. Power Gain and Power Added Efficiency versus Output Power

TYPICAL CHARACTERISTICS — 1800 MHz

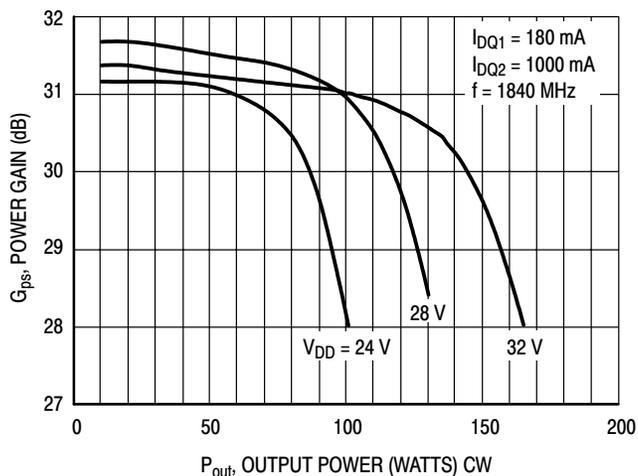

Figure 39. Power Gain versus Output Power

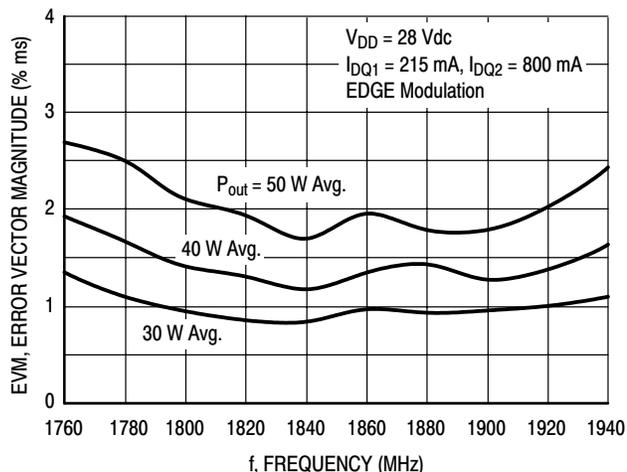

Figure 40. EVM versus Frequency

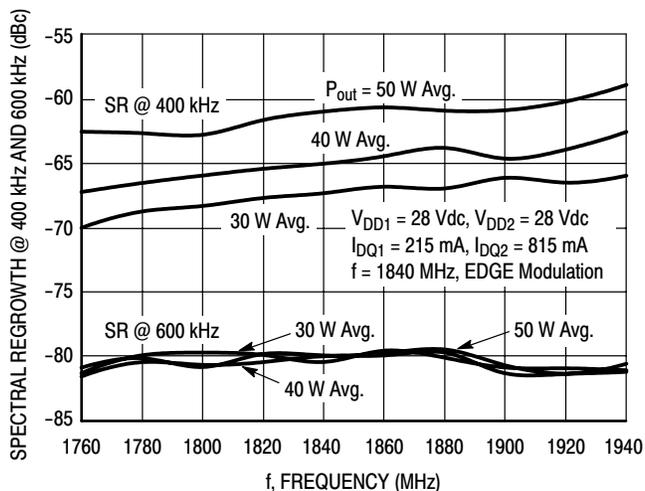

Figure 41. Spectral Regrowth at 400 kHz and 600 kHz versus Frequency

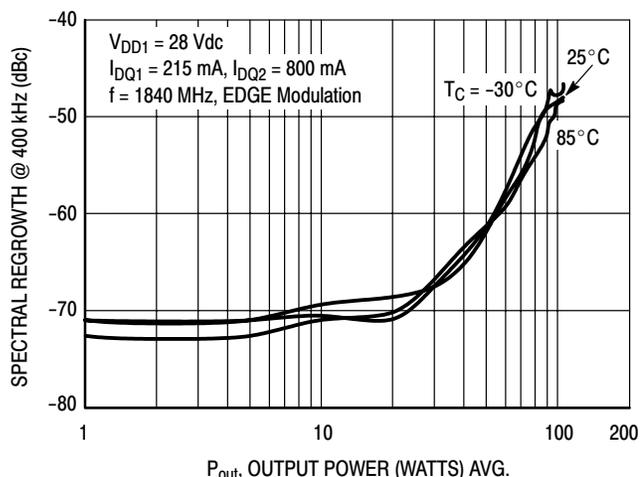

Figure 42. Spectral Regrowth at 400 kHz versus Output Power

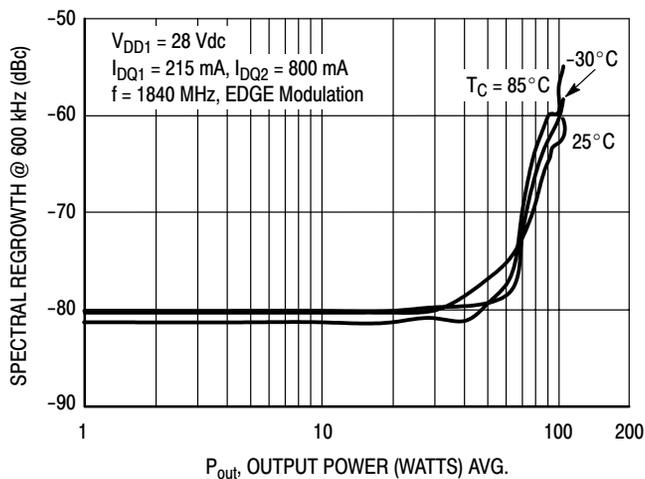

Figure 43. Spectral Regrowth at 600 kHz versus Output Power

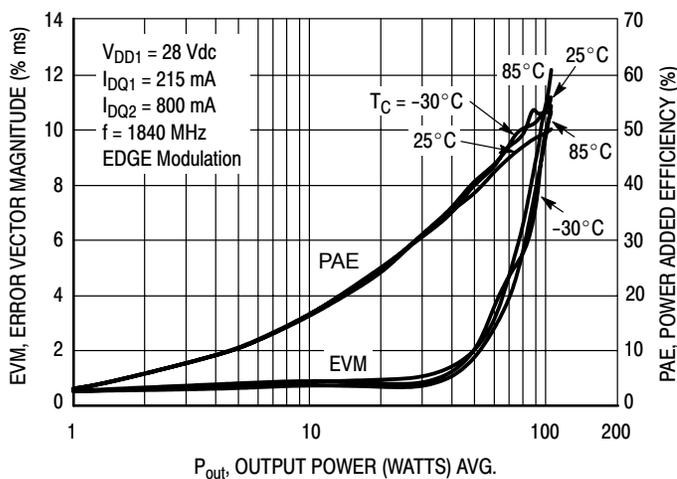

Figure 44. EVM and Power Added Efficiency versus Output Power

TYPICAL CHARACTERISTICS — 1800 MHz

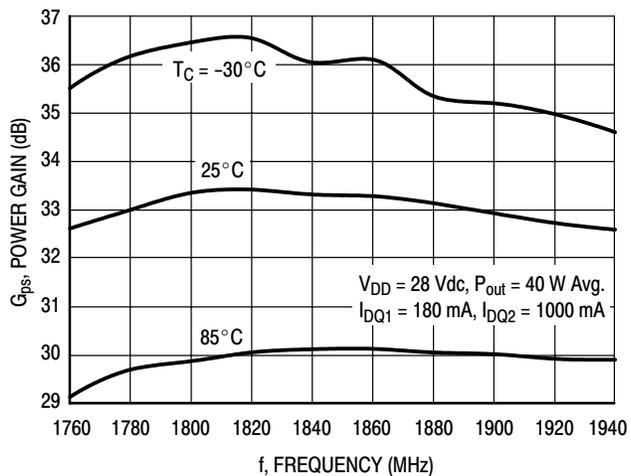
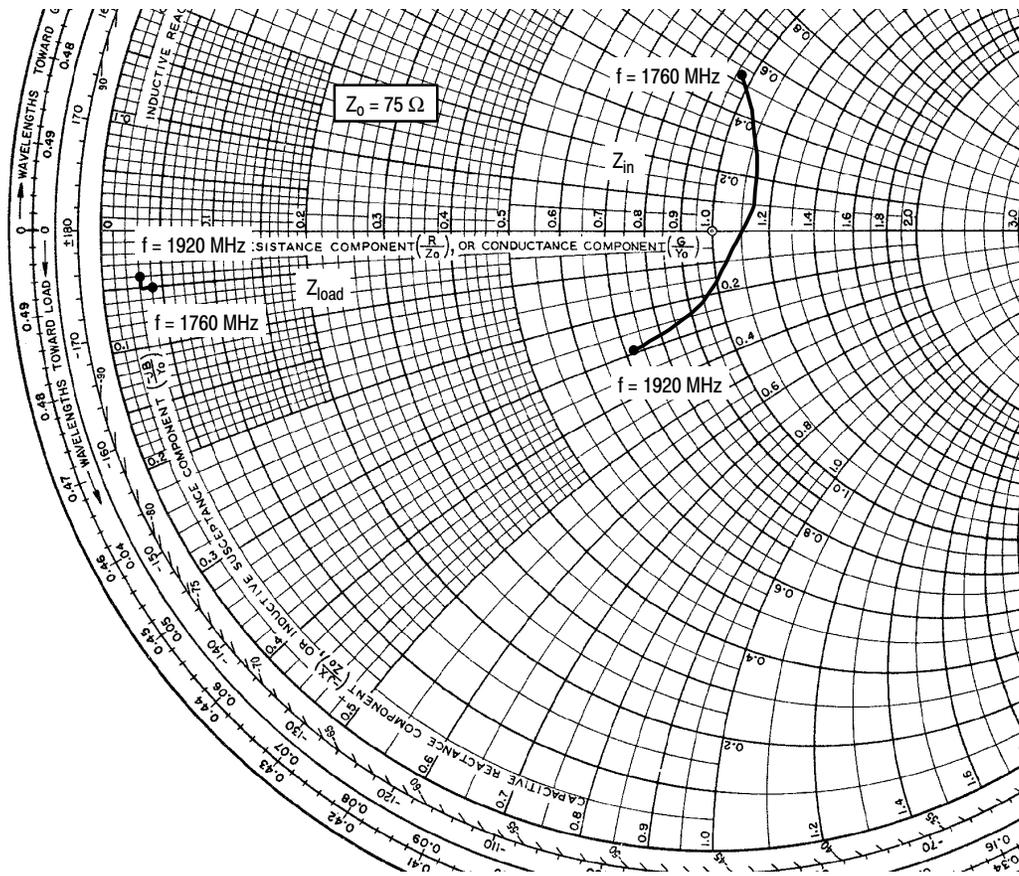

Figure 45. Power Gain versus Frequency



$V_{DD1} = V_{DD2} = 28 \text{ Vdc}$, $I_{DQ1} = 180 \text{ mA}$, $I_{DQ2} = 1000 \text{ mA}$, $P_{out} = 100 \text{ W CW}$

f MHz	Z_{in} Ω	Z_{load} Ω
1760	$71.78 + j40.05$	$2.983 - j3.974$
1780	$79.83 + j31.13$	$2.872 - j3.861$
1800	$84.35 + j19.44$	$2.757 - j3.745$
1820	$84.75 + j7.234$	$2.636 - j3.639$
1840	$81.21 - j4.076$	$2.535 - j3.506$
1860	$74.76 - j12.32$	$2.434 - j3.376$
1880	$67.49 - j17.89$	$2.324 - j3.239$
1900	$60.03 - j20.86$	$2.234 - j3.105$
1920	$53.65 - j21.94$	$2.135 - j2.965$

Z_{in} = Device input impedance as measured from gate to ground.

Z_{load} = Test circuit impedance as measured from drain to ground.

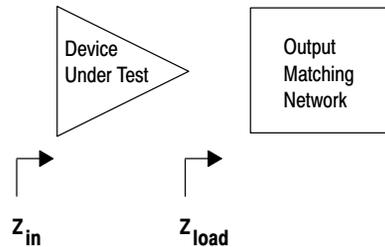
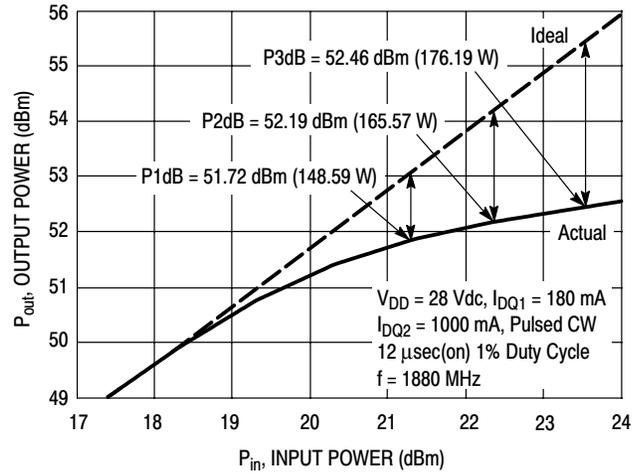

Figure 46. Series Equivalent Input and Load Impedance — 1800 MHz

ALTERNATIVE PEAK TUNE LOAD PULL CHARACTERISTICS — 1800 MHz



NOTE: Load Pull Test Fixture Tuned for Peak Output Power @ 28 V

Test Impedances per Compression Level

	Z_{source} Ω	Z_{load} Ω
P3dB	83.04 - j2.44	1.36 - j3.19

Figure 47. Pulsed CW Output Power versus Input Power @ 28 V

PACKAGE DIMENSIONS

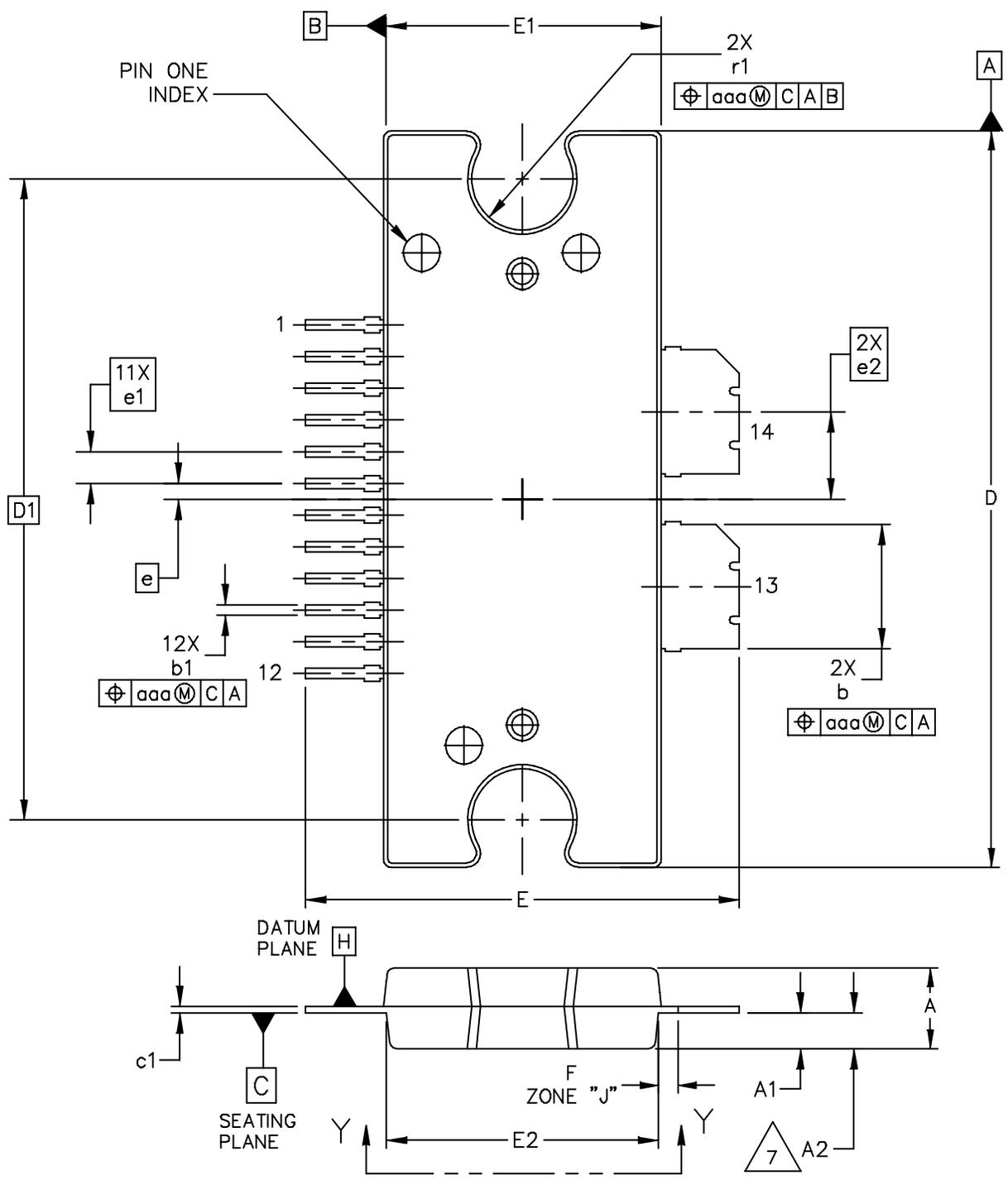

© FREESCALE SEMICONDUCTOR, INC. ALL RIGHTS RESERVED.	MECHANICAL OUTLINE	PRINT VERSION NOT TO SCALE	
TITLE: TO-272 WIDE BODY 14 LEAD	DOCUMENT NO: 98ASA10649D		REV: A
	CASE NUMBER: 1617-02		27 JUN 2007
	STANDARD: NON-JEDEC		

MW7IC18100NR1 MW7IC18100GNR1 MW7IC18100NBR1

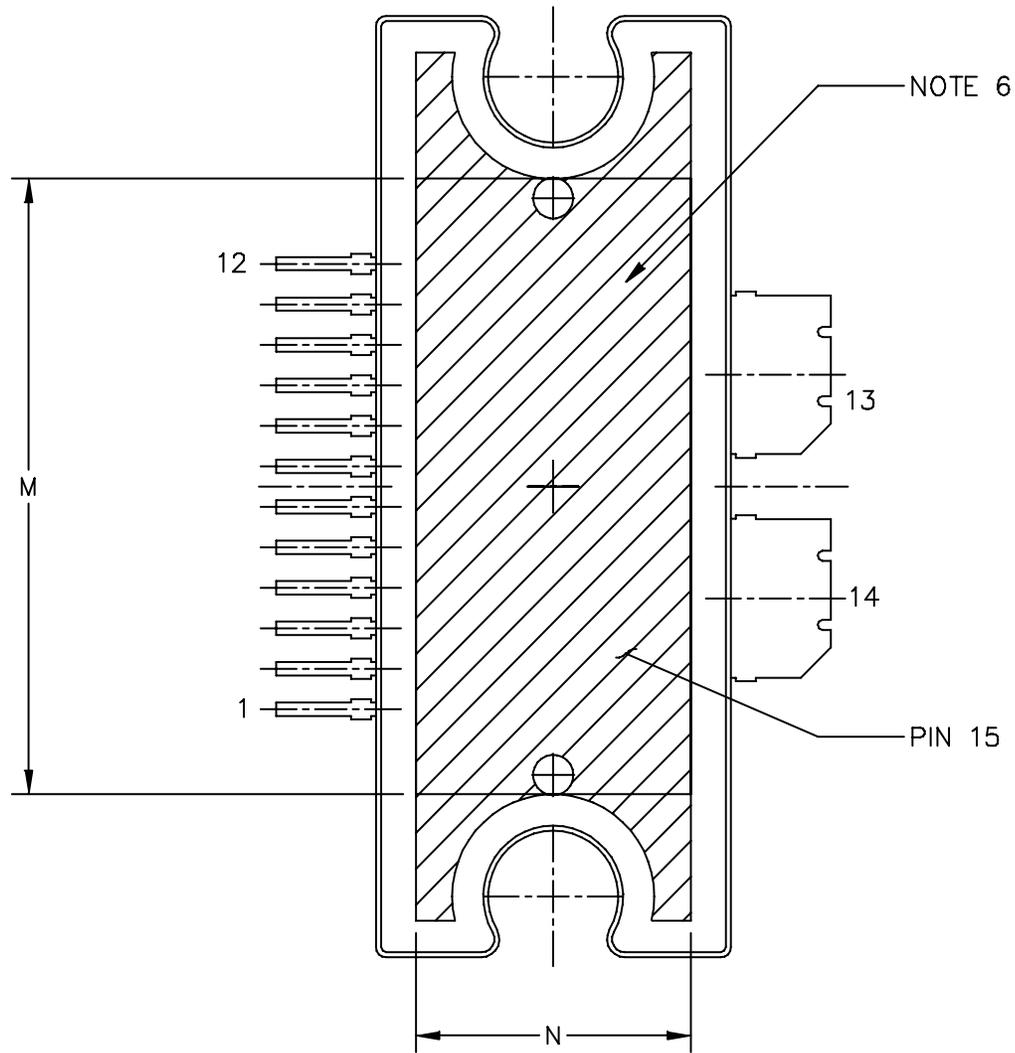

VIEW Y-Y

© FREESCALE SEMICONDUCTOR, INC. ALL RIGHTS RESERVED.	MECHANICAL OUTLINE	PRINT VERSION NOT TO SCALE	
TITLE: TO-272 WIDE BODY 14 LEAD	DOCUMENT NO: 98ASA10649D	REV: A	
	CASE NUMBER: 1617-02	27 JUN 2007	
	STANDARD: NON-JEDEC		

NOTES:

1. CONTROLLING DIMENSION: INCH
2. INTERPRET DIMENSIONS AND TOLERANCES PER ASME Y14.5M-1994.
3. DATUM PLANE -H- IS LOCATED AT THE TOP OF LEAD AND IS COINCIDENT WITH THE LEAD WHERE THE LEAD EXITS THE PLASTIC BODY AT THE TOP OF THE PARTING LINE.
4. DIMENSIONS "D" AND "E1" DO NOT INCLUDE MOLD PROTRUSION. ALLOWABLE PROTRUSION IS .006 (0.15) PER SIDE. DIMENSIONS "D" AND "E1" DO INCLUDE MOLD MISMATCH AND ARE DETERMINED AT DATUM PLANE -H-.
5. DIMENSIONS "b" AND "b1" DO NOT INCLUDE DAMBAR PROTRUSION. ALLOWABLE DAMBAR PROTRUSION SHALL BE .005 (0.13) TOTAL IN EXCESS OF THE "b" AND "b1" DIMENSIONS AT MAXIMUM MATERIAL CONDITION.
6. HATCHING REPRESENTS THE EXPOSED AREA OF THE HEAT SLUG.
7. DIM A2 APPLIES WITHIN ZONE "J" ONLY.

DIM	INCH		MILLIMETER		DIM	INCH		MILLIMETER	
	MIN	MAX	MIN	MAX		MIN	MAX	MIN	MAX
A	.100	.104	2.54	2.64	b	.154	.160	3.91	4.06
A1	.039	.043	0.99	1.09	b1	.010	.016	0.25	0.41
A2	.040	.042	1.02	1.07	c1	.007	.011	0.18	0.28
D	.928	.932	23.57	23.67	e	.020 BSC		0.51 BSC	
D1	.810 BSC		20.57 BSC		e1	.040 BSC		1.02 BSC	
E	.551	.559	14.00	14.20	e2	.1105 BSC		2.807 BSC	
E1	.353	.357	8.97	9.07	r1	.063	.068	1.6	1.73
E2	.346	.350	8.79	8.89					
F	.025 BSC		0.64 BSC		aaa	.004		0.10	
M	.600	----	15.24	----					
N	.270	----	6.86	----					
© FREESCALE SEMICONDUCTOR, INC. ALL RIGHTS RESERVED.			MECHANICAL OUTLINE			PRINT VERSION NOT TO SCALE			
TITLE: TO-272 WIDE BODY 14 LEAD					DOCUMENT NO: 98ASA10649D			REV: A	
					CASE NUMBER: 1617-02			27 JUN 2007	
					STANDARD: NON-JEDEC				

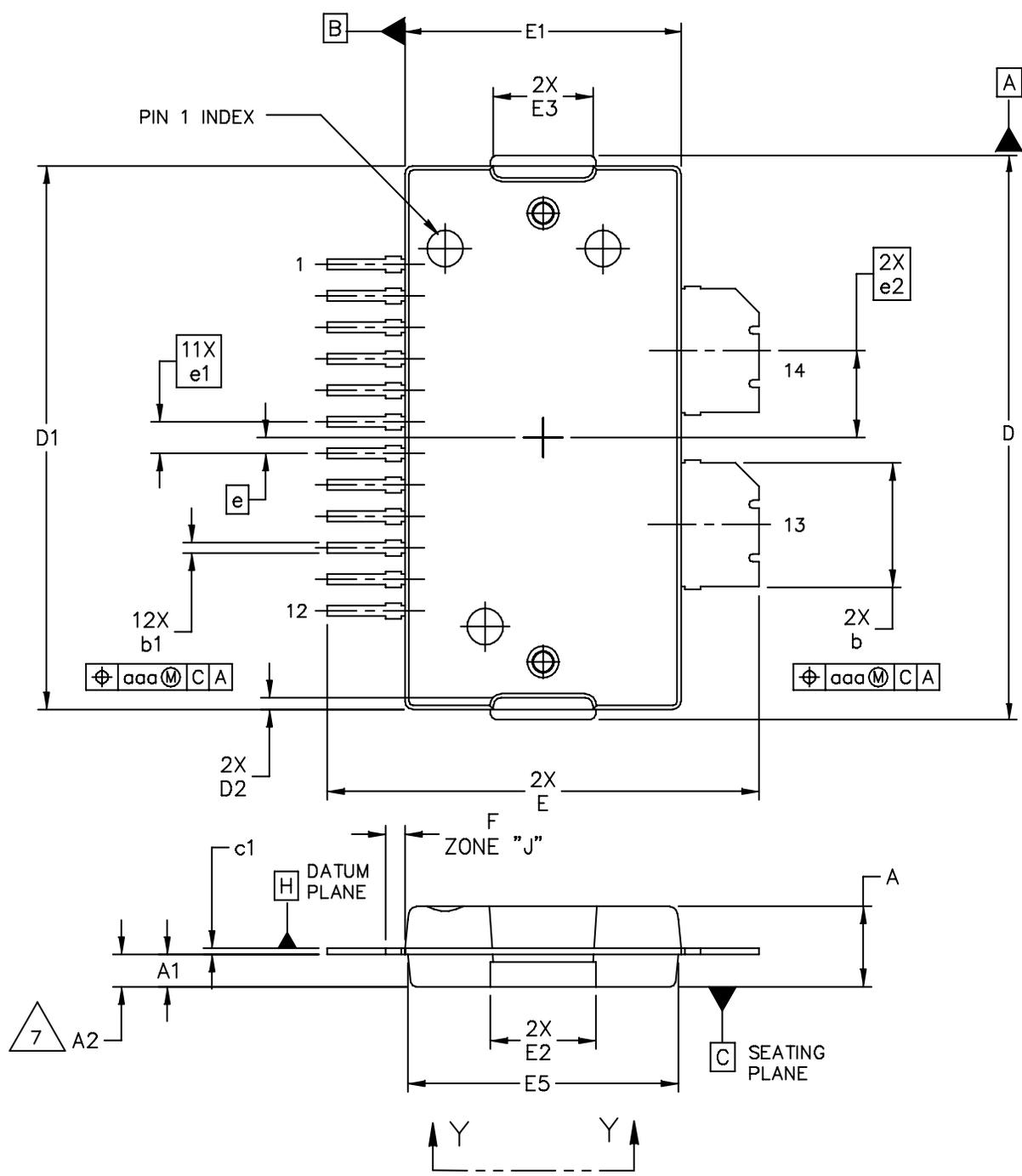

© FREESCALE SEMICONDUCTOR, INC. ALL RIGHTS RESERVED.	MECHANICAL OUTLINE	PRINT VERSION NOT TO SCALE	
TITLE: TO-270 WIDE BODY 14 LEAD	DOCUMENT NO: 98ASA10650D	REV: A	
	CASE NUMBER: 1618-02	19 JUN 2007	
	STANDARD: NON-JEDEC		

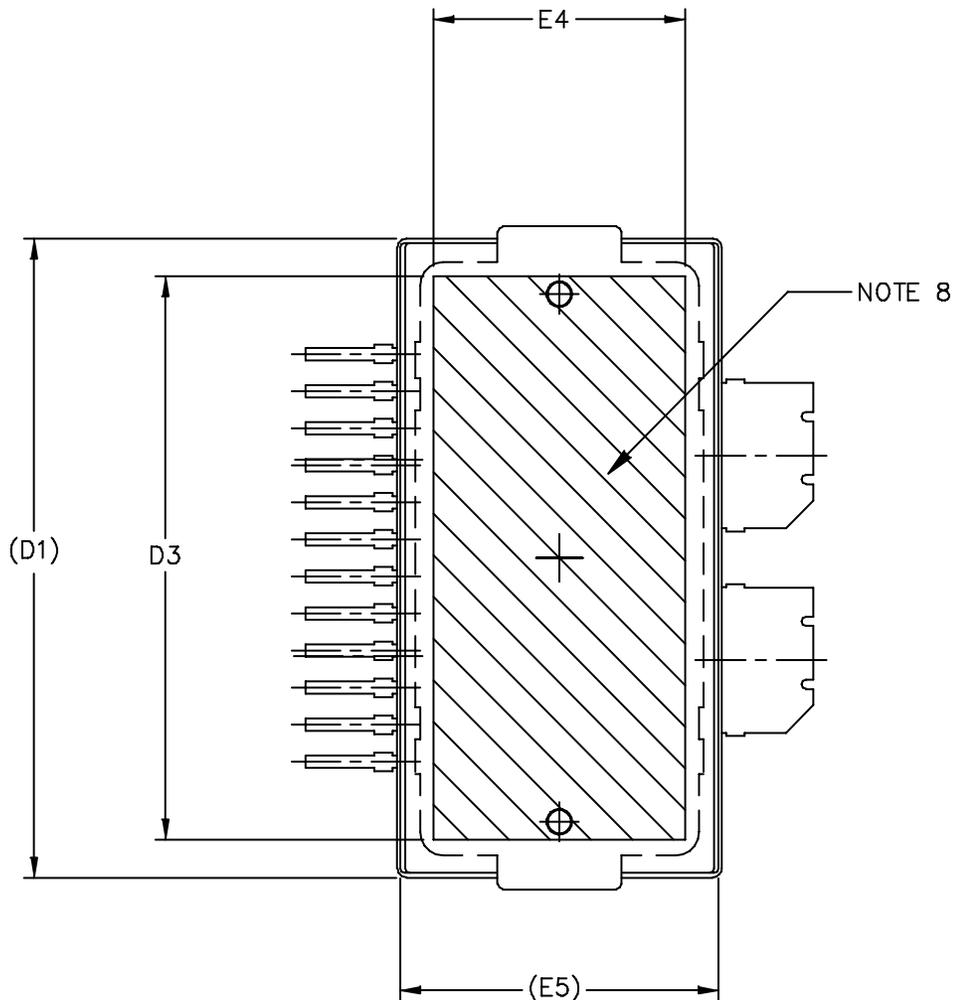

VIEW Y-Y

© FREESCALE SEMICONDUCTOR, INC. ALL RIGHTS RESERVED.	MECHANICAL OUTLINE	PRINT VERSION NOT TO SCALE	
TITLE: TO-270 WIDE BODY 14 LEAD		DOCUMENT NO: 98ASA10650D	REV: A
		CASE NUMBER: 1618-02	19 JUN 2007
		STANDARD: NON-JEDEC	

NOTES:

1. CONTROLLING DIMENSION: INCH
2. INTERPRET DIMENSIONS AND TOLERANCES PER ASME Y14.5M-1994.
3. DATUM PLANE -H- IS LOCATED AT THE TOP OF LEAD AND IS COINCIDENT WITH THE LEAD WHERE THE LEAD EXITS THE PLASTIC BODY AT THE TOP OF THE PARTING LINE.
4. DIMENSIONS "D" AND "E1" DO NOT INCLUDE MOLD PROTRUSION. ALLOWABLE PROTRUSION IS .006 PER SIDE. DIMENSIONS "D" AND "E1" DO INCLUDE MOLD MISMATCH AND ARE DETERMINED AT DATUM PLANE -H-.
5. DIMENSIONS "b" AND "b1" DOES NOT INCLUDE DAMBAR PROTRUSION. ALLOWABLE DAMBAR PROTRUSION SHALL BE .005 TOTAL IN EXCESS OF THE "b" AND "b1" DIMENSION AT MAXIMUM MATERIAL CONDITION.
6. DATUMS -A- AND -B- TO BE DETERMINED AT DATUM PLANE -H-.
7. DIMENSION A2 APPLIES WITHIN ZONE "J" ONLY.
8. HATCHING REPRESENTS THE EXPOSED AREA OF THE HEAT SLUG.

DIM	INCH		MILLIMETER		DIM	INCH		MILLIMETER	
	MIN	MAX	MIN	MAX		MIN	MAX	MIN	MAX
A	.100	.104	2.54	2.64	F	.025 BSC		0.64 BSC	
A1	.039	.043	0.99	1.09	b	.154	.160	3.91	4.06
A2	.040	.042	1.02	1.07	b1	.010	.016	0.25	0.41
D	.712	.720	18.08	18.29	c1	.007	.011	.18	.28
D1	.688	.692	17.48	17.58	e	.020 BSC		0.51 BSC	
D2	.011	.019	0.28	0.48	e1	.040 BSC		1.02 BSC	
D3	.600	---	15.24	---	e2	.1105 BSC		2.807 BSC	
E	.551	.559	14	14.2					
E1	.353	.357	8.97	9.07	aaa	.004		.10	
E2	.132	.140	3.35	3.56					
E3	.124	.132	3.15	3.35					
E4	.270	---	6.86	---					
E5	.346	.350	8.79	8.89					
© FREESCALE SEMICONDUCTOR, INC. ALL RIGHTS RESERVED.			MECHANICAL OUTLINE			PRINT VERSION NOT TO SCALE			
TITLE: TO-270 WIDE BODY 14 LEAD					DOCUMENT NO: 98ASA10650D			REV: A	
					CASE NUMBER: 1618-02			19 JUN 2007	
					STANDARD: NON-JEDEC				

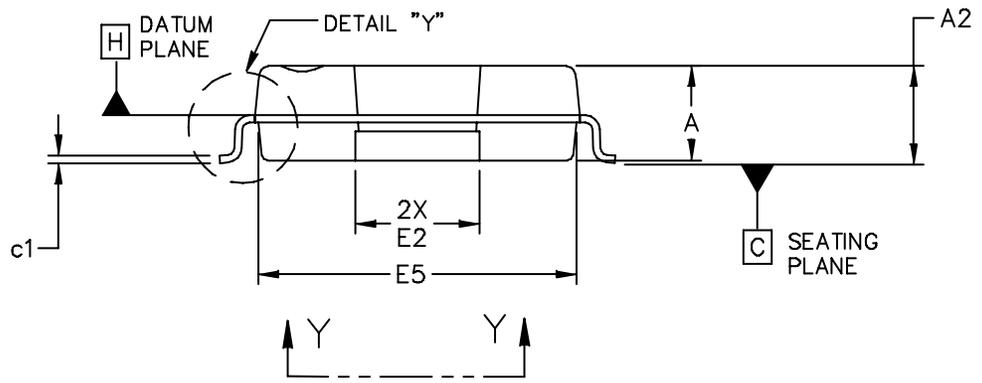
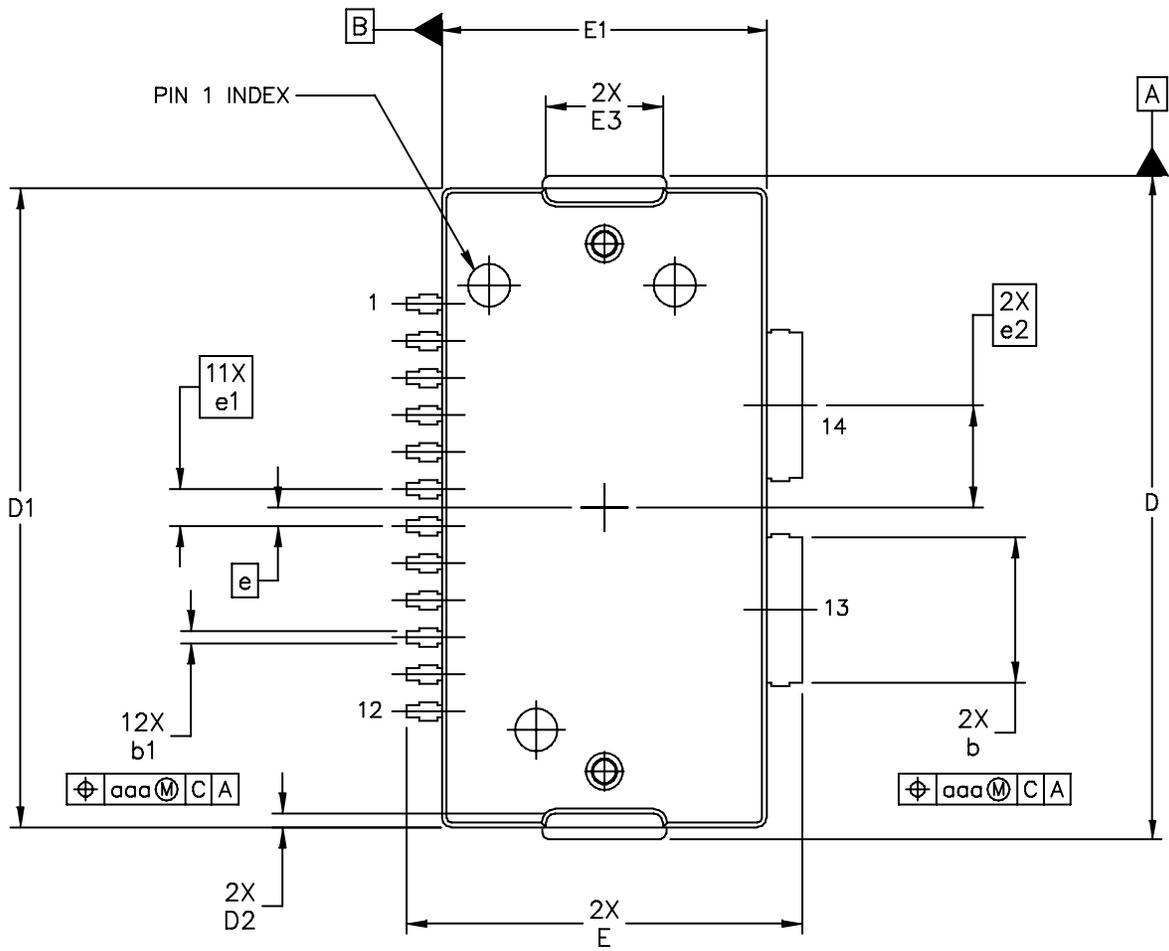

© FREESCALE SEMICONDUCTOR, INC. ALL RIGHTS RESERVED.	MECHANICAL OUTLINE	PRINT VERSION NOT TO SCALE	
TITLE: TO-270 WIDE BODY 14 LEAD GULL WING	DOCUMENT NO: 98ASA10653D	REV: A	
	CASE NUMBER: 1621-02	19 JUN 2007	
	STANDARD: NON-JEDEC		

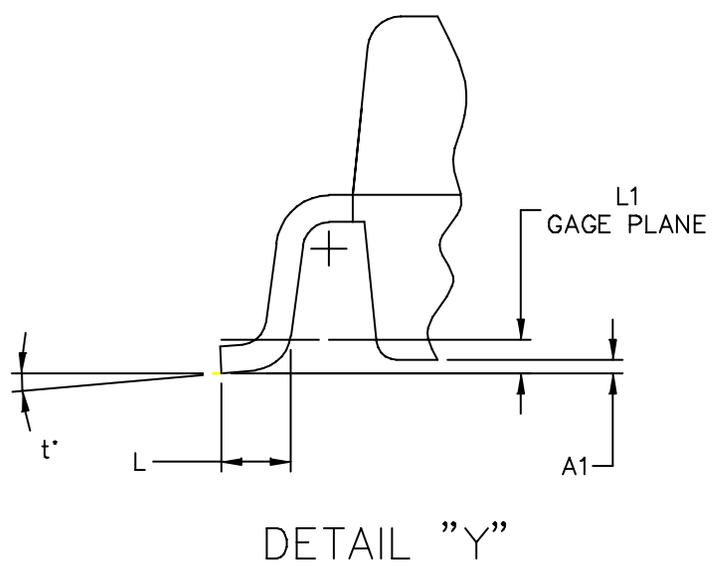
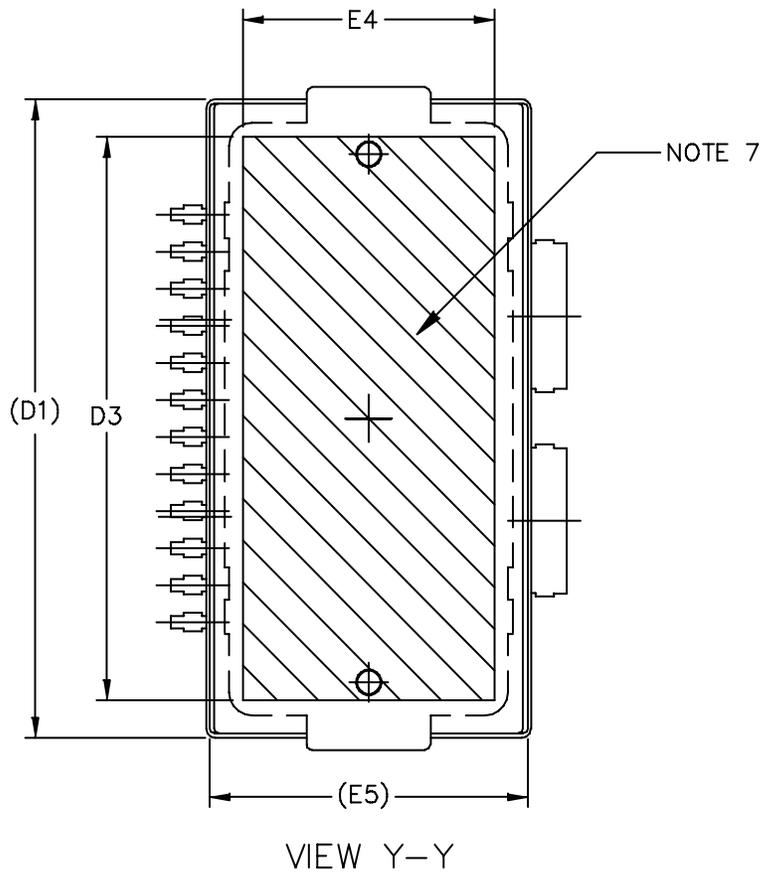

© FREESCALE SEMICONDUCTOR, INC. ALL RIGHTS RESERVED.	MECHANICAL OUTLINE	PRINT VERSION NOT TO SCALE	
TITLE: TO-270 WIDE BODY 14 LEAD GULL WING	DOCUMENT NO: 98ASA10653D	REV: A	
	CASE NUMBER: 1621-02	19 JUN 2007	
	STANDARD: NON-JEDEC		

MW7IC18100NR1 MW7IC18100GNR1 MW7IC18100NBR1

NOTES:

1. CONTROLLING DIMENSION: INCH
2. INTERPRET DIMENSIONS AND TOLERANCES PER ASME Y14.5M-1994.
3. DATUM PLANE -H- IS LOCATED AT THE TOP OF LEAD AND IS COINCIDENT WITH THE LEAD WHERE THE LEAD EXITS THE PLASTIC BODY AT THE TOP OF THE PARTING LINE.
4. DIMENSIONS "D" AND "E1" DO NOT INCLUDE MOLD PROTRUSION. ALLOWABLE PROTRUSION IS .006 PER SIDE. DIMENSIONS "D" AND "E1" DO INCLUDE MOLD MISMATCH AND ARE DETERMINED AT DATUM PLANE -H-.
5. DIMENSIONS "b" AND "b1" DOES NOT INCLUDE DAMBAR PROTRUSION. ALLOWABLE DAMBAR PROTRUSION SHALL BE .005 TOTAL IN EXCESS OF THE "b" AND "b1" DIMENSION AT MAXIMUM MATERIAL CONDITION.
6. DATUMS -A- AND -B- TO BE DETERMINED AT DATUM PLANE -H-.
7. HATCHING REPRESENTS THE EXPOSED AREA OF THE HEAT SLUG.

DIM	INCH		MILLIMETER		DIM	INCH		MILLIMETER	
	MIN	MAX	MIN	MAX		MIN	MAX	MIN	MAX
A	.100	.104	2.54	2.64	L	.018	.024	0.46	0.61
A1	.001	.004	0.02	0.10	L1	.010 BSC		0.25 BSC	
A2	.099	.110	2.51	2.79	b	.154	.160	3.91	4.06
D	.712	.720	18.08	18.29	b1	.010	.016	0.25	0.41
D1	.688	.692	17.48	17.58	c1	.007	.011	.18	.28
D2	.011	.019	0.28	0.48	e	.020 BSC		0.51 BSC	
D3	.600	---	15.24	---	e1	.040 BSC		1.02 BSC	
E	.429	.437	10.9	11.1	e2	.1105 BSC		2.807 BSC	
E1	.353	.357	8.97	9.07	t	2'	8'	2'	8'
E2	.132	.140	3.35	3.56					
E3	.124	.132	3.15	3.35	aaa	.004		.10	
E4	.270	---	6.86	---					
E5	.346	.350	8.79	8.89					
© FREESCALE SEMICONDUCTOR, INC. ALL RIGHTS RESERVED.			MECHANICAL OUTLINE			PRINT VERSION NOT TO SCALE			
TITLE: TO-270 WIDE BODY 14 LEAD GULL WING					DOCUMENT NO: 98ASA10653D			REV: A	
					CASE NUMBER: 1621-02			19 JUN 2007	
					STANDARD: NON-JEDEC				

PRODUCT DOCUMENTATION

Refer to the following documents to aid your design process.

Application Notes

- AN1907: Solder Reflow Attach Method for High Power RF Devices in Plastic Packages
- AN1955: Thermal Measurement Methodology of RF Power Amplifiers
- AN1977: Quiescent Current Thermal Tracking Circuit in the RF Integrated Circuit Family
- AN1987: Quiescent Current Control for the RF Integrated Circuit Device Family
- AN3263: Bolt Down Mounting Method for High Power RF Transistors and RFICs in Over-Molded Plastic Packages
- AN3789: Clamping of High Power RF Transistors and RFICs in Over-Molded Plastic Packages

Engineering Bulletins

- EB212: Using Data Sheet Impedances for RF LDMOS Devices

REVISION HISTORY

The following table summarizes revisions to this document.

Revision	Date	Description
0	May 2007	<ul style="list-style-type: none"> • Initial Release of Data Sheet
1	June 2007	<ul style="list-style-type: none"> • Removed Case Operating Temperature from Maximum Ratings table, p. 2. Case Operating Temperature rating will be added to the Maximum Ratings table when parts' Operating Junction Temperature is increased to 225°C.
2	Apr. 2008	<ul style="list-style-type: none"> • Operating Junction Temperature increased from 200°C to 225°C in Maximum Ratings table, related "Continuous use at maximum temperature will affect MTTF" footnote added and changed 200°C to 225°C in Capable Plastic Package bullet, p. 1, 2 • Added Case Operating Temperature limit to the Maximum Ratings table and set limit to 150°C, p. 2 • Updated PCB information to show more specific material details, Figs. 3, 27, Test Circuit Schematic, p. 4, 14 • Updated Part Numbers in Tables 6, 8, Component Designations and Values, to RoHS compliant part numbers, p. 4, 14 • Replaced Case Outline 1617-01 with 1617-02, Issue A, p. 22-24. Revised cross-hatched area for exposed heat spreader. Added pin numbers 1, 12, 13, and 14 to Sheets 1 and 2. Corrected mm Min and Max values for dimension A1 to 0.99 and 1.09, respectively. • Replaced Case Outline 1618-01 with 1618-02, Issue A, p. 25-27. Added pin numbers 1, 12, 13, and 14 and Pin 1 Index designation to Sheet 1. Corrected dimensions e and e1 on Sheet 1. Removed Pin 5 designation from Sheet 2. • Replaced Case Outline 1621-01 with 1621-02, Issue A, p. 28-30. Added pin numbers 1, 12, 13, and 14 and Pin 1 Index designation to Sheet 1. Corrected dimensions e and e1 on Sheets 1 and 3. Removed Pin 5 designation from Sheet 2.
3	Mar. 2009	<ul style="list-style-type: none"> • Changed Storage Temperature Range in Max Ratings table from -65 to +200 to -65 to +150 for standardization across products, p. 2. • Updated Human Body Model ESD from Class 0 to 1 to reflect 2008 Human Body Model actual test data, p. 2 • Added footnote, Measurement made with device in straight lead configuration before any lead forming operation is applied, to Functional Tests table, p. 2.

How to Reach Us:

Home Page:

www.freescale.com

Web Support:

<http://www.freescale.com/support>

USA/Europe or Locations Not Listed:

Freescale Semiconductor, Inc.
Technical Information Center, EL516
2100 East Elliot Road
Tempe, Arizona 85284
1-800-521-6274 or +1-480-768-2130
www.freescale.com/support

Europe, Middle East, and Africa:

Freescale Halbleiter Deutschland GmbH
Technical Information Center
Schatzbogen 7
81829 Muenchen, Germany
+44 1296 380 456 (English)
+46 8 52200080 (English)
+49 89 92103 559 (German)
+33 1 69 35 48 48 (French)
www.freescale.com/support

Japan:

Freescale Semiconductor Japan Ltd.
Headquarters
ARCO Tower 15F
1-8-1, Shimo-Meguro, Meguro-ku,
Tokyo 153-0064
Japan
0120 191014 or +81 3 5437 9125
support.japan@freescale.com

Asia/Pacific:

Freescale Semiconductor China Ltd.
Exchange Building 23F
No. 118 Jianguo Road
Chaoyang District
Beijing 100022
China
+86 10 5879 8000
support.asia@freescale.com

For Literature Requests Only:

Freescale Semiconductor Literature Distribution Center
P.O. Box 5405
Denver, Colorado 80217
1-800-441-2447 or +1-303-675-2140
Fax: +1-303-675-2150
LDCForFreescaleSemiconductor@hibbertgroup.com

Information in this document is provided solely to enable system and software implementers to use Freescale Semiconductor products. There are no express or implied copyright licenses granted hereunder to design or fabricate any integrated circuits or integrated circuits based on the information in this document.

Freescale Semiconductor reserves the right to make changes without further notice to any products herein. Freescale Semiconductor makes no warranty, representation or guarantee regarding the suitability of its products for any particular purpose, nor does Freescale Semiconductor assume any liability arising out of the application or use of any product or circuit, and specifically disclaims any and all liability, including without limitation consequential or incidental damages. "Typical" parameters that may be provided in Freescale Semiconductor data sheets and/or specifications can and do vary in different applications and actual performance may vary over time. All operating parameters, including "Typicals", must be validated for each customer application by customer's technical experts. Freescale Semiconductor does not convey any license under its patent rights nor the rights of others. Freescale Semiconductor products are not designed, intended, or authorized for use as components in systems intended for surgical implant into the body, or other applications intended to support or sustain life, or for any other application in which the failure of the Freescale Semiconductor product could create a situation where personal injury or death may occur. Should Buyer purchase or use Freescale Semiconductor products for any such unintended or unauthorized application, Buyer shall indemnify and hold Freescale Semiconductor and its officers, employees, subsidiaries, affiliates, and distributors harmless against all claims, costs, damages, and expenses, and reasonable attorney fees arising out of, directly or indirectly, any claim of personal injury or death associated with such unintended or unauthorized use, even if such claim alleges that Freescale Semiconductor was negligent regarding the design or manufacture of the part.

Freescale™ and the Freescale logo are trademarks of Freescale Semiconductor, Inc. All other product or service names are the property of their respective owners.

© Freescale Semiconductor, Inc. 2007-2009. All rights reserved.