

Features

Power Module

- Wide Vin 4.3 to 65VDC
- High power density (LxWxH = 12.19x12.19x3.75)
- Wide operating temperature -40°C to +95°C at full load
- Efficiency up to 89%, no need for heatsinks
- 6-sided shielding
- Thermally and EMI enhanced 25 pad LGA package
- Low profile



RPMH-0.5

0.5 Amp Single Output



EN55032 compliant

Description

The RPMH-0.5 series is a wide input voltage, 0.5A non-isolated switching regulator power module. The module accepts with up to 65VDC input and provides a trimmable output from 2.6 up to 28VDC and comes complete with a full set of features including adjustable output, sequencing, soft-start control, on/off control, and power good signals. The ultra-compact module has a profile of only 3.75mm, but with an efficiency of up to 89%, the device can operate at full load in ambient temperatures as high as +95°C and with power derating up to 105°C without forced air cooling. The package is complete with 6-sided shielding for optimal EMC performance and excellent heat management.

Selection Guide

Part Number	Input Voltage Range ⁽¹⁾ [VDC]	Output Voltage [VDC]	Vout Adjust Range [VDC]	Output Current max. [A]	Efficiency typ. [%]	Max Capacitive typ. Load ⁽²⁾ [µF]
RPMH3.3-0.5	4.3 - 65	3.3	2.64 - 3.63	0.5	72	80000
RPMH5.0-0.5	6 - 65	5	4 - 5.5	0.5	77	50000
RPMH12-0.5	13.5 - 65	12	7.2 - 13.2	0.5	82	20000
RPMH15-0.5	16.5 - 65	15	9 - 16.5	0.5	85	13200
RPMH24-0.5	25.5 - 65	24	15 - 28	0.5	89	9400

Notes:

Note1: Input voltage must be higher than desired output voltage. Check buck mode and 100% duty cycle mode

Note2: Max. Cap Load is tested at nominal input and full resistive load

Model Numbering

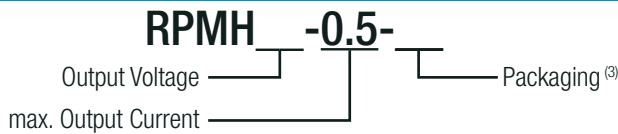

Notes:

Note3: Add suffix "-CT" for tube packaging for more details refer to "PACKAGING INFORMATION" without suffix, standard tape and reel packaging

Specifications @ Ta= 25°C, nom. Vin, full load, with output cap ⁽⁴⁾ after warm-up unless otherwise stated

BASIC CHARACTERISTICS					
Parameter	Condition		Min.	Typ.	Max.
Internal Input Filter			capacitor		
Input Voltage Range	Buck mode	3.3Vout 5.0Vout 12Vout 15Vout 24Vout	4.3VDC 6VDC 13.5VDC 16.5VDC 25.5VDC		65VDC
	100% duty cycle mode ⁽⁵⁾	Vout= Vin - Vdrop 3.3Vout 5.0Vout 12Vout 15Vout 24Vout	3VDC		4.3VDC 6VDC 13.5VDC 16.5VDC 25.5VDC
Absolute Maximum Input Voltage					68VDC
Undervoltage Lockout (UVLO)	DC-DC ON DC-DC OFF		2.6VDC 2.35VDC		2.95VDC 2.6VDC

continued on next page



www.recom-power.com/eval-ref-boards

Notes:

Note4: Output capacitor required. Please refer to "Output Capacitor".

Specifications (@ Ta= 25°C, nom. Vin, full load, with output cap ⁽⁴⁾ after warm-up unless otherwise stated)

Parameter	Condition		Min.	Typ.	Max.
Input Current	nom. Vin= 48VDC	3.3Vout		48mA	
		5.0Vout		68mA	
		12Vout		152mA	
		15Vout		184mA	
		24Vout		281mA	
Quiescent Current	nom. Vin= 48VDC	3.3Vout, 5.0Vout		16µA	50µA
		12Vout, 15Vout		50µA	100µA
		24Vout		100µA	150µA
Internal Power Dissipation	nom. Vin= 48VDC	3.3Vout		0.64W	
		5.0Vout		0.75W	
		12Vout, 15Vout		1.32W	
		24Vout		1.48W	
Output Voltage Trimming ⁽⁶⁾			2.64VDC		28VDC
Minimum Dropout Voltage (Vdrop) ⁽⁷⁾	Vin min. = Vdrop + Vout	3.3Vout, 5Vout		2V/A	
		others		3V/A	
Minimum Load			0%		
Start-up Time	without using soft start function/ power up by using CTRL function			1.5ms	
Rise-time				900µs	
ON/OFF CTRL		DC-DC ON DC-DC OFF		Open or 1.22V < V _{CTRL} < Vin Short or -0.3V < V _{CTRL} < 1.14VDC	
Standby Current		DC-DC OFF	15µA		
Internal Operating Frequency		3.3Vout 5.0Vout 12Vout, 15Vout, 24Vout		300kHz 400kHz 600kHz	
Output Ripple and Noise ⁽⁸⁾	20MHz BW	3.3Vout		20mVp-p	100mVp-p
		5.0Vout		35mVp-p	
		12Vout		40mVp-p	
		15Vout, 24Vout		30mVp-p	

Notes:

Note5: As input approaches output voltage set point, device enters 100% duty cycle mode. In 100% duty cycle mode, Vout equals Vin minus dropout voltage (refer to **"Dropout Voltage vs. Load"**)

Note6: For more detailed information, please refer to **"OUTPUT VOLTAGE TRIMMING"**

Note7: Required dropout voltage per 1A output current to be within accuracy (refer to **"Dropout Voltage vs. Load"**)

Note8: Measurements are made with a 22µF MLCC across output (low ESR)

Efficiency vs. Load

RPMH3.3-0.5

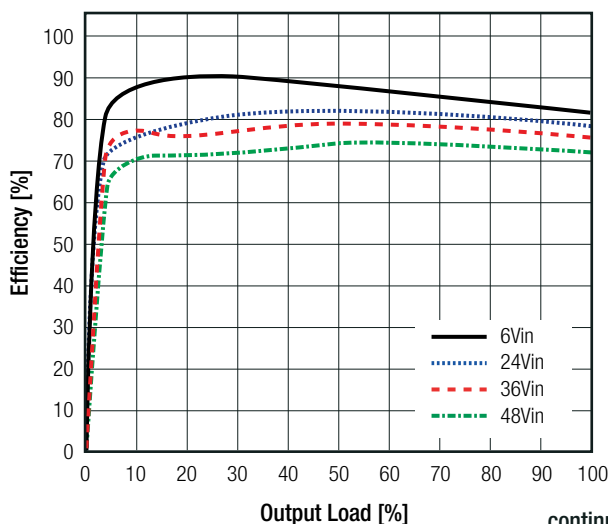

continued on next page

RPMH5.0-0.5

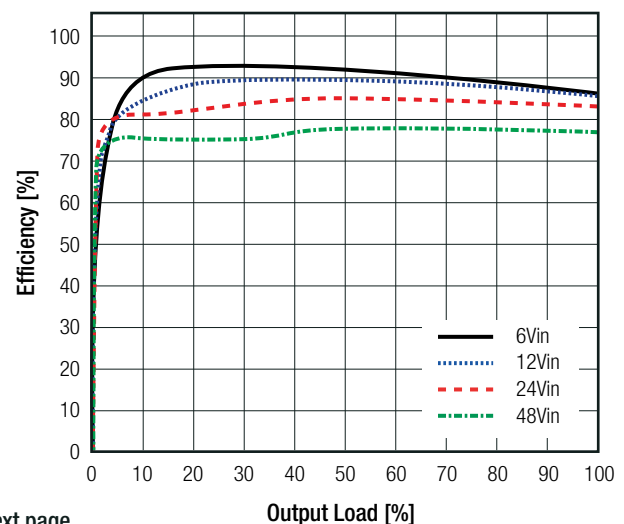

Specifications (@ Ta= 25°C, nom. Vin, full load, with output cap ⁽⁴⁾ after warm-up unless otherwise stated)

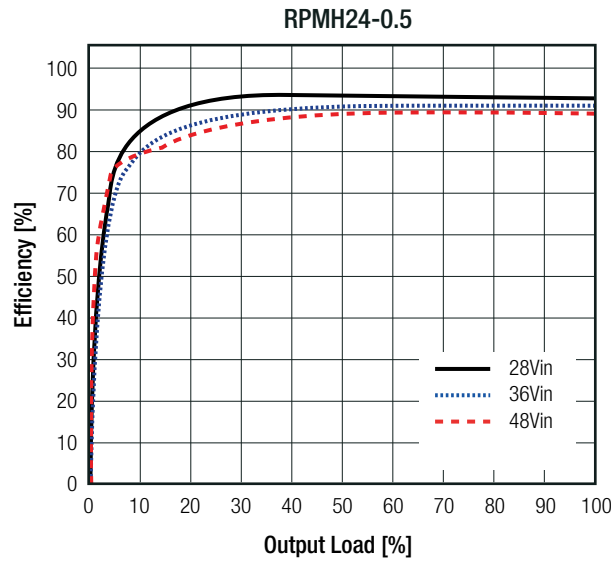
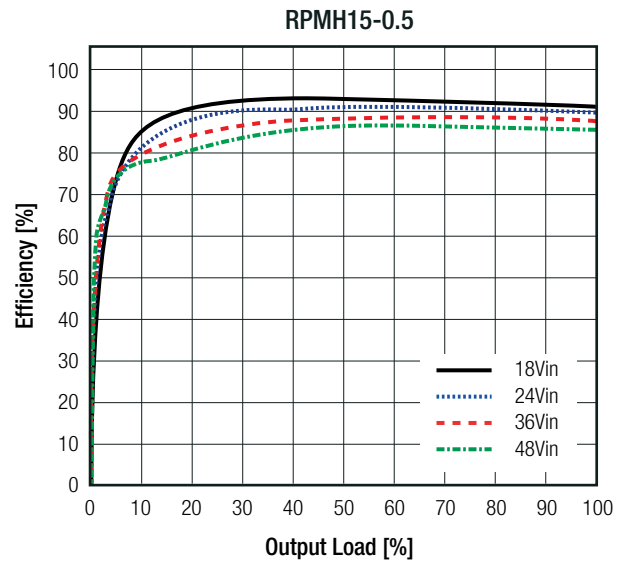
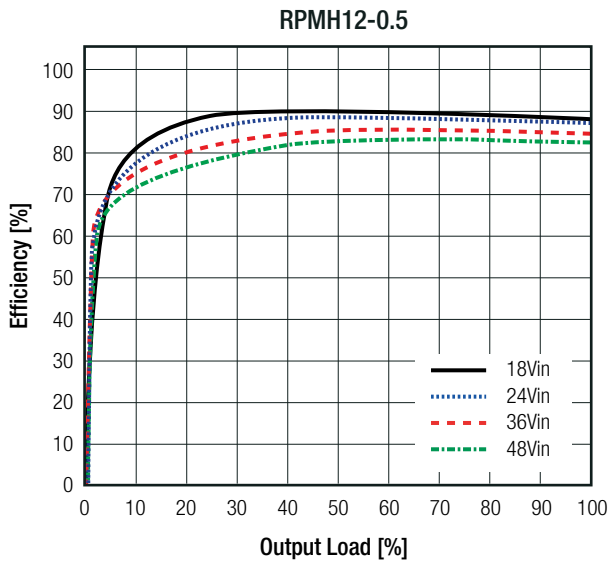

Dropout Voltage vs. Load

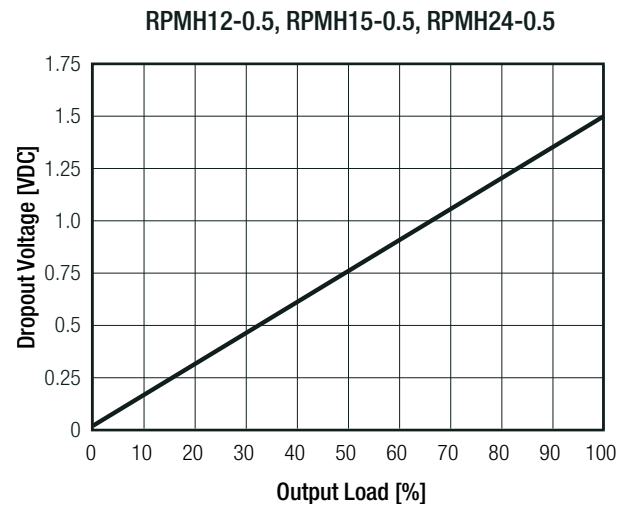
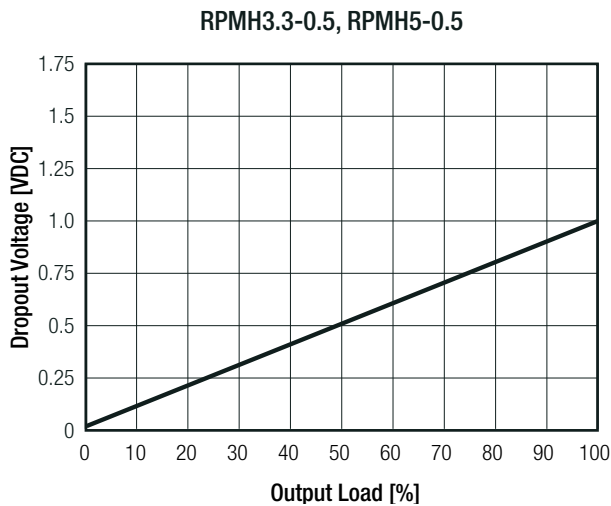

continued on next page

Specifications (@ Ta= 25°C, nom. Vin, full load, with output cap ⁽⁴⁾ after warm-up unless otherwise stated)

Output Capacitor

The RPMH requires MLCC output capacitors for normal operation (see table).

Output Capacitance	
V _{out_nom}	C _{OUT}
3.3VDC, 5.0VDC	--
12VDC	10uF 25V X7R 1206
15VDC	10uF 25V X7R 1206
24VDC	2 x 10uF 50V X7R 1210

OUTPUT VOLTAGE TRIMMING

The RPMH-series offers the feature of trimming the output voltage by using external trim resistors. The values for trim resistors shown in trim tables below are according to standard E96 values; therefore, the specified voltage may slightly vary. Refer to **"Selection Guide"**

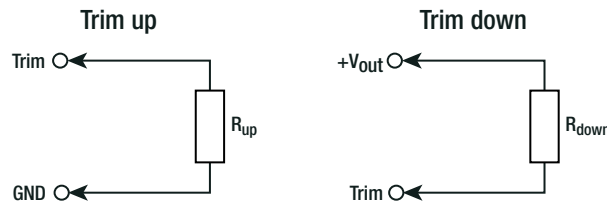

- V_{out_nom} = nominal output voltage [VDC]
- V_{out_set} = trimmed output voltage [VDC]
- V_{ref} = reference voltage [VDC]
- R_{up} = trim up resistor [Ω]
- R_{down} = trim down resistor [Ω]
- R_{Hi}, R_{Lo} = internal resistors [Ω]

V _{out_nom}	R _{Hi}	R _{Lo}	V _{ref}
3.3VDC	205kΩ	169kΩ	1.223VDC
5.0VDC	374kΩ	309kΩ	
12VDC	1.22MΩ	1MΩ	
15VDC	1.22MΩ	1MΩ	
24VDC	1.22MΩ	1MΩ	

Calculation:

$$R_{up} = \left[\frac{R_{Hi}}{V_{out_set} - V_{nom}} \right]$$

Practical Example RPMH3.3-0.5, trim up

$$V_{out_set} = 3.63VDC$$

$$R_{up} = \left[\frac{205k}{3.63 - 3.3} \right] = \underline{\underline{621k\Omega}}$$

R_{up} according to E96 ≈ 619kΩ

$$R_{down} = \left[\frac{(V_{out_set} - V_{ref}) \times R_{Lo}}{V_{out_nom} - V_{out_set}} \right]$$

Practical Example RPMH3.3-0.5, trim down

$$V_{out_set} = 2.64VDC$$

$$R_{down} = \left[\frac{(2.64 - 1.223) \times 169k}{3.3 - 2.64} \right] = \underline{\underline{363k\Omega}}$$

R_{down} according to E96 ≈ 365kΩ

RPMH3.3-0.5

Trim up

V _{out_set} =	3.4	3.5	3.63	[VDC]
R _{up} (E96) ≈	2M05	1M02	619k	[Ω]

Trim down

V _{out_set} =	3.1	3	2.8	2.64	[VDC]
R _{down} (E96) ≈	1M58	1M	536k	365k	[Ω]

RPMH5.0-0.5

Trim up

V _{out_set} =	5.1	5.3	5.5	[VDC]
R _{up} (E96) ≈	3M74	1M24	750k	[Ω]

Trim down

V _{out_set} =	4.7	4.5	4.3	4	[VDC]
R _{down} (E96) ≈	3M57	2M	1M33	845k	[Ω]

continued on next page

Specifications (@ Ta= 25°C, nom. Vin, full load, with output cap ⁽⁴⁾ after warm-up unless otherwise stated)

RPMH12-0.5

Trim up

V _{out_set} =	12.4	12.6	12.8	13	13.2	[VDC]
R _{up} (E96) ≈	3M01	2M	1M5	1M2	1M	[Ω]

Trim down

V _{out_set} =	10	9.6	9	8.5	8	7.7	7.2	[VDC]
R _{down} (E96) ≈	4M32	3M4	2M61	2M05	1M69	1M5	1M24	[Ω]

RPMH15-0.5

Trim up

V _{out_set} =	15.5	15.7	15.9	16.1	16.3	16.5	[VDC]
R _{up} (E96) ≈	2M4	1M74	1M33	1M1	931k	820k	[Ω]

Trim down

V _{out_set} =	12	11.5	11	10.5	10	9.5	9	[VDC]
R _{down} (E96) ≈	3M6	2M94	2M4	2M05	1M74	1M5	1M3	[Ω]

RPMH24-0.5

Trim up

V _{out_set} =	24.5	25	25.5	26	26.4	27	28	[VDC]
R _{up} (E96) ≈	2M43	1M2	806k	604k	511k	402k	300k	[Ω]

Trim down

V _{out_set} =	19.5	19.2	18	17.5	17	16.5	16	15.5	15	[VDC]
R _{down} (E96) ≈	3M9	3M74	2M8	2M49	2M26	2M	1M82	1M69	1M5	[Ω]

REMOTE SENSE

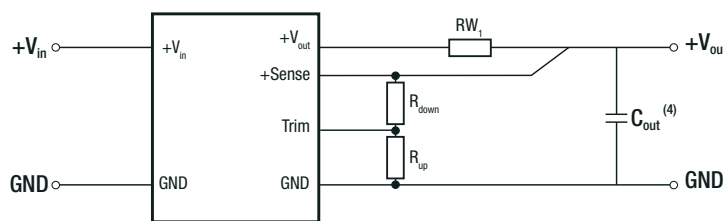

RW₁ ... wire losses +
R_{up} ... trim up resistor
R_{down} ... trim down resistor

The output voltage can be adjusted via the trim and sense functions. The maximum output voltage from trim and sense function combined is listed in the table below. Derating may be required when using trim and/or sense functions.

V _{out_nom}	V _{out_max.}
3.3VDC	3.63VDC
5.0VDC	5.5VDC
12VDC	13.2VDC
15VDC	16.5VDC
24VDC	28VDC

POSITIVE TO NEGATIVE

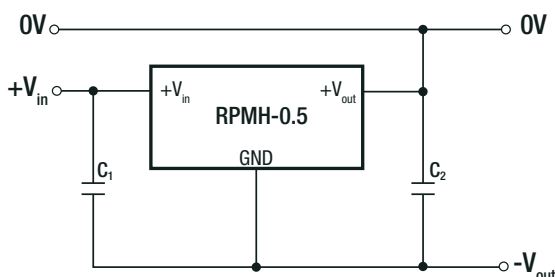

C₁ and C₂ may be added to reduced ripple and should be fitted close to the converter pins.

Notes:

Note9: RECOM Power Modules can also be used to convert a positive voltage into a negative voltage. Parameters such as maximum Vin, efficiency and maximum operating temperature are reduced. Please contact RECOM for further details.

Specifications (@ Ta= 25°C, nom. Vin, full load, with output cap ⁽⁴⁾ after warm-up unless otherwise stated)

REGULATIONS			
Parameter	Condition	Value	
Output Accuracy		±2.0% typ. / ±4.8% max.	
Line Regulation	low line to high line	RPMH3.3-0.5 (4.3-65VDC)	±2.5% typ.
		RPMH5.0-0.5 (6-65VDC)	±3.0% typ.
		RPMH12-0.5 (13.5-65VDC) RPMH15-0.5 (16.5-65VDC)	±3.5% typ.
		RPMH24-0.5 (25.5-65VDC)	±3.0% typ.
Load Regulation ⁽¹⁰⁾	20% to 100% load step recovery time	0.5% typ.	
Transient Response	25% load step change	100mVp-p	
	recovery time	2ms	

Note:

Note10: Operation below 20% load will not harm the converter, but specifications may not be met

Sequencing Multiple Modules

The SEQ pin can be used to program the rising edge of the output voltage. An internal current source charges a soft-start capacitor which is connected from the sequencing pin to GND. The following equation is used to calculate the soft-start capacitor:

$$C_{ss} = \text{soft-start capacitor}$$

$$t_{ss} = \text{required soft-start time}$$

$$n = \text{number of RPMHs}$$

$$C_{ss} [nF] = (8.1 \times n) \times t_{ss} [ms]$$

To sequence multiple power module start-up times, the power good (PGood) pin and the CTRL pin may be used. In below schematic, the RPMH(n) starts after RPMH(1) reaches its set output voltage and the power good signal is set to high which then enables RPMH(n). After RPMH(n) reaches its set output voltage, it enables RPMH(n+1).

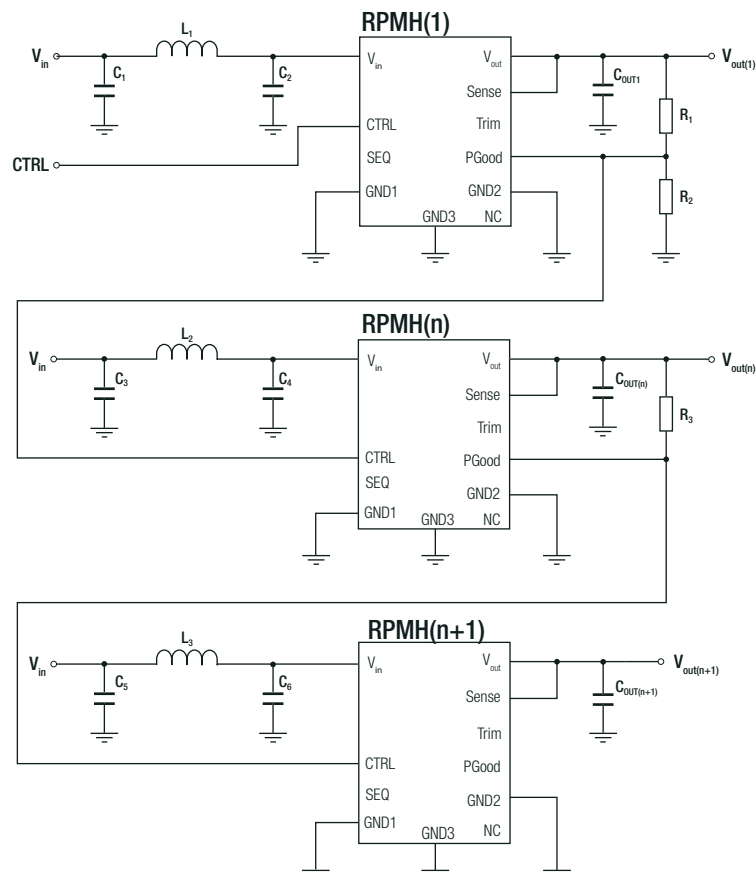

Specifications (@ Ta= 25°C, nom. Vin, full load, with output cap ⁽⁴⁾ after warm-up unless otherwise stated)

To sequence multiple converters to start at the same time (set output voltage is reached at the same time), the following schematic may be used:

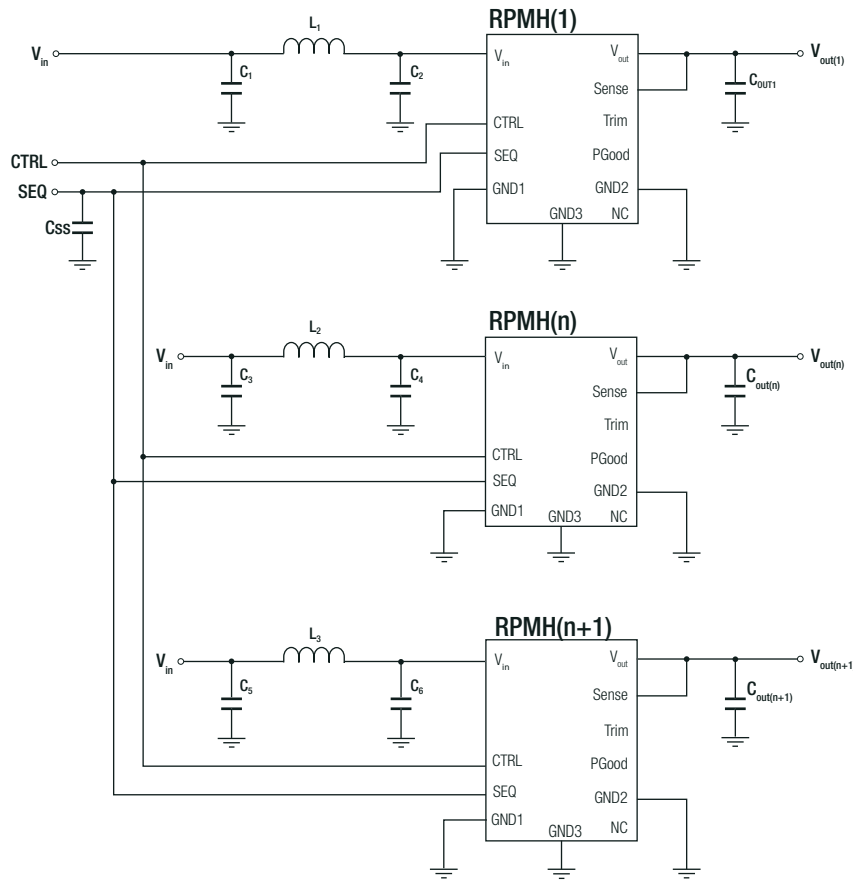

PROTECTIONS		
Parameter	Condition	Value
Short Circuit Protection (SCP)	less than 50mΩ	hiccup mode, automatic recovery
Over Current Protection (OCP)		120% min.

ENVIRONMENTAL		
Parameter	Condition	Value
Operating Temperature Range ⁽¹¹⁾	@ natural convection 0.1m/s (refer to "Derating Graph")	-40°C to +105°C
Maximum Case Temperature	measured on tc point (refer to "Dimension Drawing")	+105°C
Temperature Coefficient		0.02%/K typ.
Thermal Impedance ⁽¹¹⁾	natural convection 0.1m/s, horizontal (T _{case} to T _{AMB})	8K/W typ.
Operating Altitude	@ natural convection 0.1m/s	5000m
Operating Humidity	non-condensing	5% - 95% RH
Shock	MIL-STD-810G, Method 516.6, Procedure I	40g, 11ms, saw-tooth, 3 shocks ± per axis 3 axis; unit is operating
	MIL-STD-810G, Method 516.6, Procedure IV	drop on 50mm plywood on concrete 26 times from 1 meter
Random Vibration	MIL-STD-810G, Method 514.6, Procedure I, Category 24	Category 24 - Figure 514.6E-1 - power spectral density = 0.04g ² /Hz at 20Hz - 1000Hz; -6dB/octave at 1000Hz - 2000Hz; 60 minutes x 3 axis; unit is operating during tests
MTBF	according to MIL-HDBK-217F, G.B. @ full load	+25°C @ max. T _{AMB} 2.696 x 10 ³ hours 995 x 10 ³ hours

continued on next page

Specifications (@ Ta= 25°C, nom. Vin, full load, with output cap ⁽⁴⁾ after warm-up unless otherwise stated)

Notes:

Note11: tested with a eurocard 160x100mm 70µm copper, 4 layer

Derating Graph ⁽¹¹⁾

(@ chamber and natural convection 0.1m/s, 48Vin)

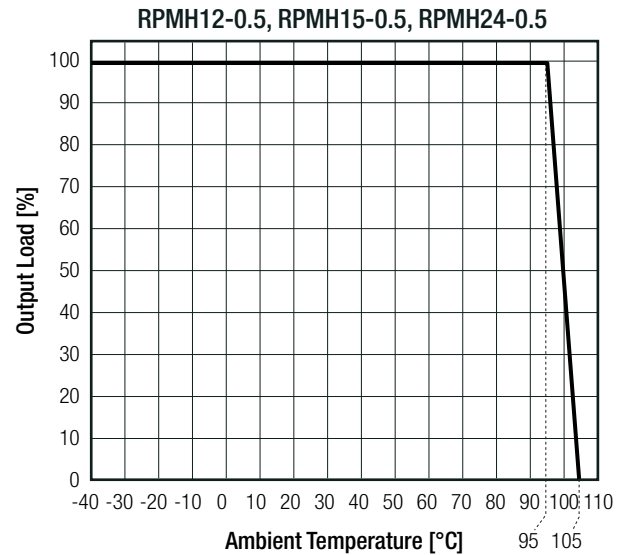
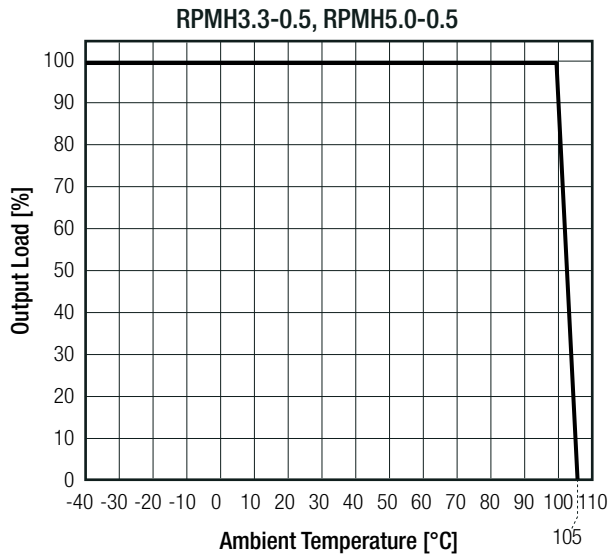

SAFETY AND CERTIFICATIONS

Certificate Type (Safety)	Report / File Number	Standard
Audio/video, information and communication technology equipment. Safety requirements	designed to meet	EN62368-1
RoHS 2		RoHS 2011/65/EU + AM2015/863

EMC Compliance	Condition	Standard / Criterion
Electromagnetic compatibility of multimedia equipment - emission requirements	with external components (refer to "EMC filtering suggestion" below)	EN55032, Class B

EMC filtering suggestion according to EN55032

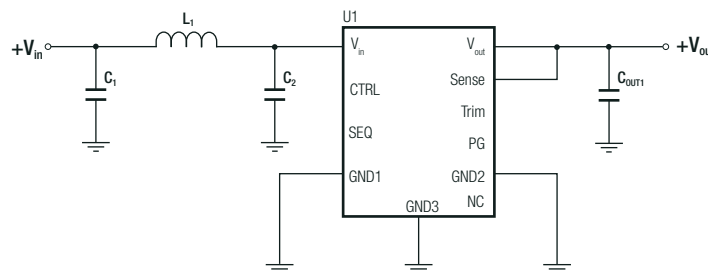

Component List Class B

U1	L1	C1	C2	C _{OUT1}
RPMH3.3-0.5	RLS-126	2.2µF 100V X7R	2 x 4.7µF 100V X7R or X7S	22µF 10V X7R
RPMH5.0-0.5				22µF 25V X7R
RPMH12-0.5				22µF 25V X7R
RPMH15-0.5				22µF 25V X7R
RPMH24-0.5				2 x 10µF 50V X7R

Specifications (@ Ta= 25°C, nom. Vin, full load, with output cap ⁽⁴⁾ after warm-up unless otherwise stated)

DIMENSION AND PHYSICAL CHARACTERISTICS

Parameter	Type	Value
Material	case PCB solder pads	metal FR4, (UL94 V-0) copper with electrolytic nickel-gold
Dimension (LxWxH)		12.19 x 12.19 x 3.75mm
Weight		1.1g typ.

Dimension Drawing (mm)

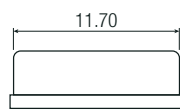
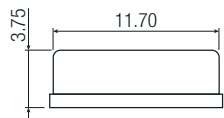
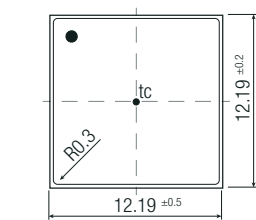
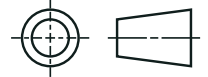

Recommended Footprint Details

Bottom View

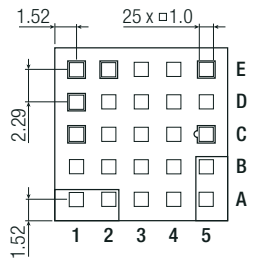

Top View

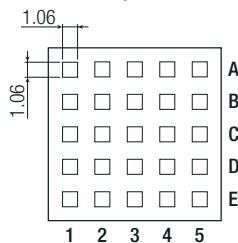

Pinning information

Pad #	Function	Description
A1, A2	Vin	Positive input voltage with respect to GND. Connect to a Vin plane for enhanced thermal performance
C1	CTRL	Active High: pull to GND to disable the device. Pull high or leave open to enable the device
A5, B5	Vout	Positive output voltage. Connect to a Vout plane for enhanced thermal performance
C5	Sense	Connect this pad to the load or directly to Vout. This pad must not be left floating
E5	Trim	Use this pad to set the output voltage (refer to "OUTPUT VOLTAGE TRIMMING" for different Vout)
E2	NC	Not connected
E1	SEQ	Used to sequence multiple converters or to set the startup time. Leave pad floating if not used
D1	PGood	Output power good. HIGH = Vout at set level, LOW = Vout not in regulation. PGOOD is connected to the drain of an NFET that holds the pin low when either FB or VOUT is not in regulation. Connect a 10kΩ to a 100kΩ pull up resistor to system voltage rail or VOUT not higher than 12V.
others	GND	Negative input voltage. Connect to GND plane(s) for enhanced thermal performance

tc = case temperature measuring point
Pad tolerance= ±0.05mm
Case tolerance= ±0.25mm

BLOCKDIAGRAM

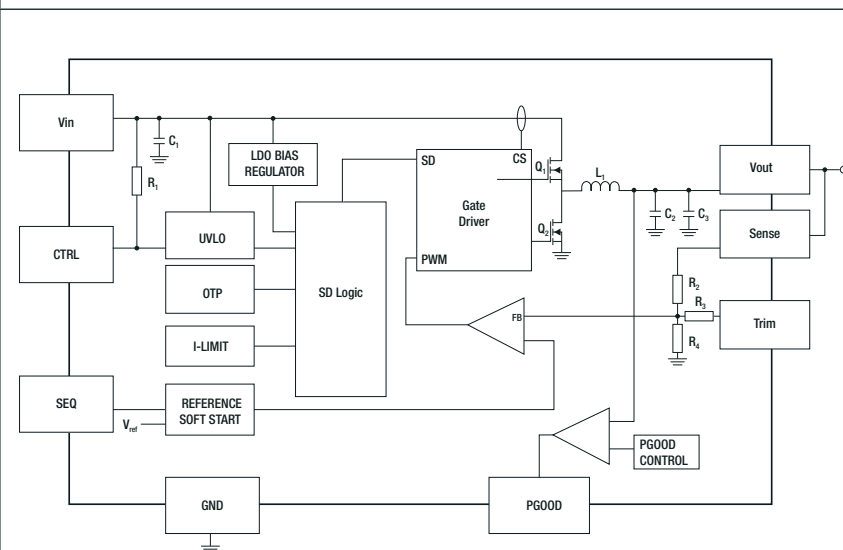

Component List

Vout _{nom}	C1	L1	C2, C3
3.3VDC	2.2μF	47μH	10μF 2pcs. in parallel
5.0VDC			
12VDC	100μH	100μH	4.7μF 2pcs. in parallel
15VDC			
24VDC			

Vout _{nom}	R1	R2	R3	R4
3.3VDC	10MΩ	169kΩ	1kΩ	100kΩ
5.0VDC		309kΩ		113kΩ
12VDC	10MΩ	1MΩ	1kΩ	88.7kΩ
15VDC				53.6kΩ
24VDC				

Specifications (@ Ta= 25°C, nom. Vin, full load, with output cap ⁽⁴⁾ after warm-up unless otherwise stated)

PACKAGING INFORMATION		
Parameter	Type	Value
Packaging Dimension (LxWxH)	tape and reel	330.2 x 330.2 x 30.4mm
	tape and reel (carton)	265.0 x 240.0 x 60.0mm
	tube ("-CT")	530.0 x 30.3 x 19.2mm
Packaging Quantity	tape and reel	200pcs
	tube ("-CT")	30pcs
Tape Width		24mm
Storage Temperature Range		-55°C to +125°C
Storage Humidity	non-condensing	95% RH max.

The product information and specifications may be subject to changes even without prior written notice. The product has been designed for various applications; its suitability lies in the responsibility of each customer. The products are not authorized for use in safety-critical applications without RECOM's explicit written consent. A safety-critical application is an application where a failure may reasonably be expected to endanger or cause loss of life, inflict bodily harm or damage property. The applicant shall indemnify and hold harmless RECOM, its affiliated companies and its representatives against any damage claims in connection with the unauthorized use of RECOM products in such safety-critical applications.