

## SINGLE-SUPPLY OPERATIONAL AMPLIFIER

### ■ GENERAL DESCRIPTION

The NJM2125 is a single-supply operational amplifier of small surface mount package.

The features of single-supply operation, low operating voltage ( minimum 2.7V ) and small package are most suitable for portable items.

### ■ PACKAGE OUTLINE



NJM2125F

### ■ FEATURES

- Single-Supply Operation
- Low Operating Voltage ( +2.7V~20V )
- Low Operating Current ( 1.0mA typ. )
- Slew Rate ( 1.2V/μs typ. )
- Small Package ( SOT-23-5 )
- Bipolar Technology

### ■ PIN CONFIGURATION

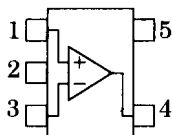

NJM2125F  
(Top View)

#### PIN FUCTION

1. +INPUT
2. GND
3. -INPUT
4. OUTPUT
5. V<sup>+</sup>

### ■ EQUIVALENT CIRCUIT

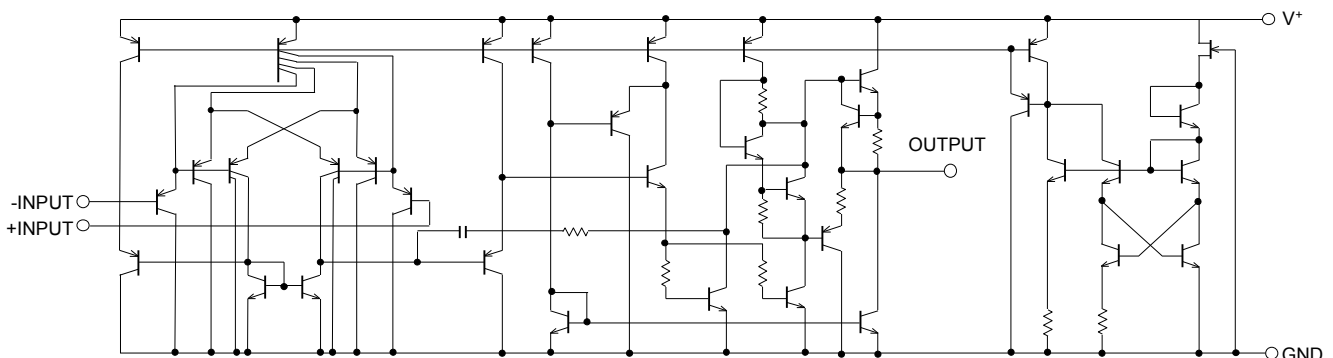

# NJM2125

## ■ ABSOLUTE MAXIMUM RATINGS

( Ta=25°C )

PARAMETER	SYMBOL	RATINGS	UNIT
Supply Voltage	$V^+$	+20	V
Differential Input Voltage	$V_{ID}$	+20	V
Input Voltage	$V_{IC}$	-0.3~+20 ( Note )	V
Power Dissipation	$P_D$	(SOT-23-5) 200	mW
Operating Temperature Range	$T_{opr}$	-40~85	°C
Storage Temperature Range	$T_{stg}$	-40~125	°C

( note ) When the supply voltage is less than +20V, the absolute maximum input voltage is equal to the supply voltage.

## ■ ELECTRICAL CHARACTERISTICS

(  $V^+=5V, T_a=25^\circ C$  )

PARAMETER	SYMBOL	TEST CONDITION	MIN.	TYP.	MAX.	UNIT
Input Offset Voltage	$V_{IO}$	$R_S=0\Omega$	-	2	7	mV
Input Offset Current	$I_{IO}$		-	5	50	nA
Input Bias Current	$I_B$		-	25	250	nA
Large Signal Voltage Gain	$A_V$	$R_L \geq 2k\Omega$	88	100	-	dB
Maximum Output Voltage Swings	$V_{OM}$	$R_L=2k\Omega$	3.5	-	-	V
Input Common Mode Voltage Range	$V_{ICM}$		0~3.5	-	-	V
Common Mode Rejection Ratio	CMR		70	90	-	dB
Supply Voltage Rejection Ratio	SVR		80	94	-	dB
Output Source Current	$I_{SOURCE}$	$V_{IN}^+=1V, V_{IN}^-=0V$	20	30	-	mA
Output Sink Current	$I_{SINK}$	$V_{IN}^+=0V, V_{IN}^-=1V$	8	20	-	mA
Operating Current	$I_{CC}$	$R_L=\infty$	-	1.0	1.75	mA
Slew Rate	SR		-	1.2	-	V/ $\mu s$
Unity Gain Frequency	$f_T$		-	1.2	-	MHz

## ■ TYPICAL CHARACTERISTICS

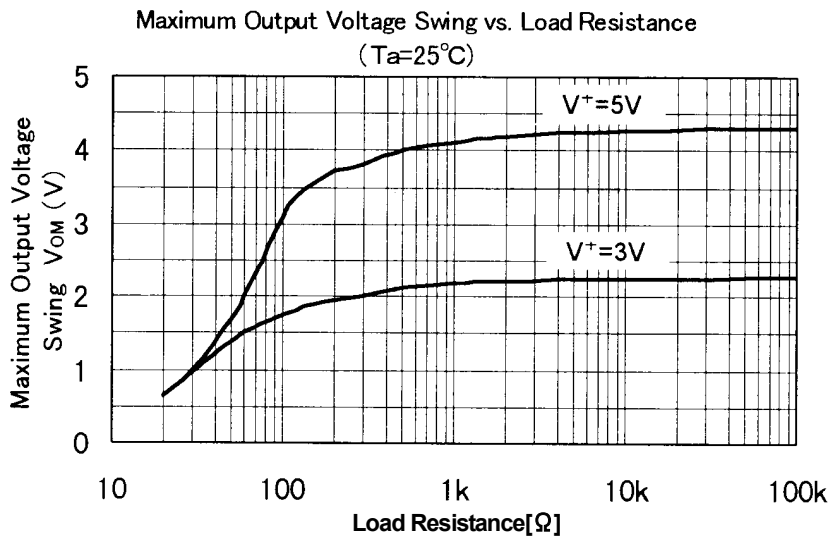
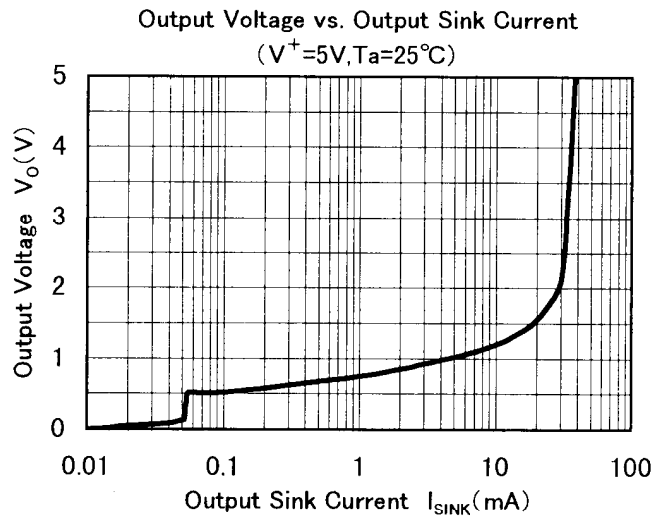
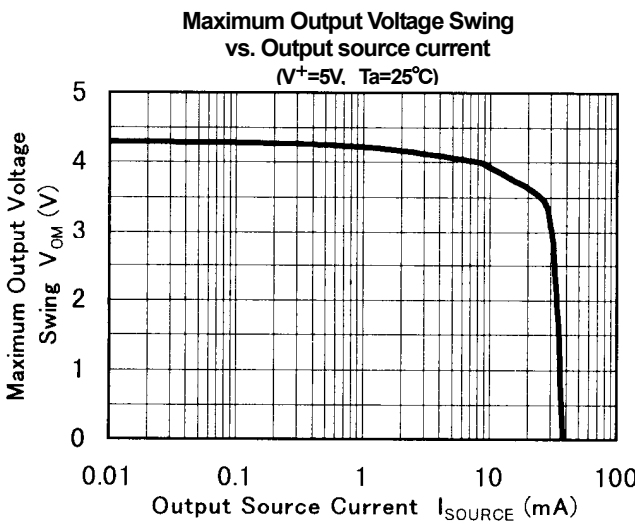
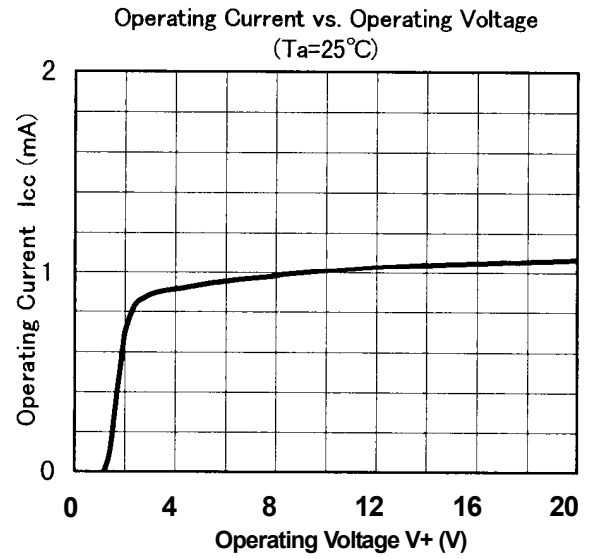
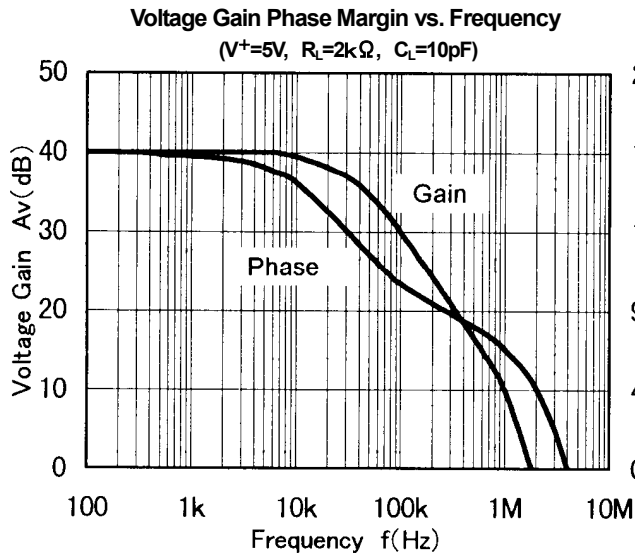

## ■ TYPICAL CHARACTERISTICS

Operating Current vs. Temperature  
( $V^+=5V$ )

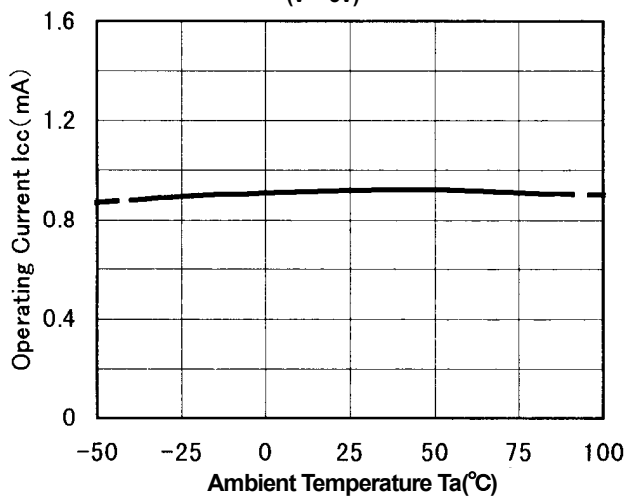

Input Offset Voltage vs. Temperature  
( $V^+=5V, R_s=0\Omega$ )

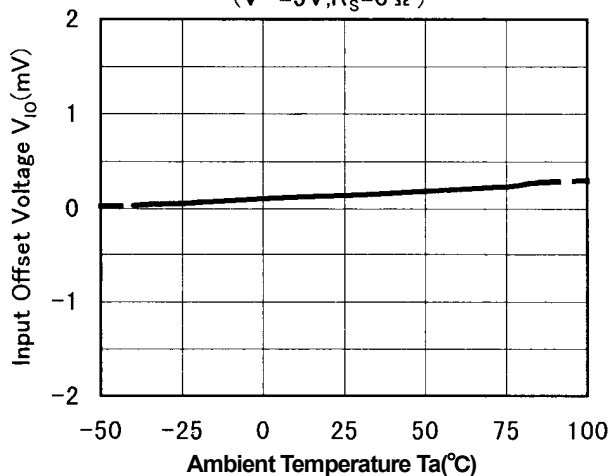

Input Offset Current vs. Temperature  
( $V^+=5V$ )

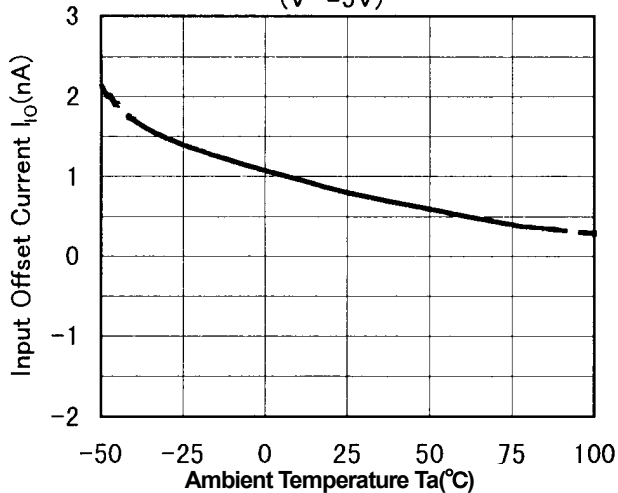

Input bias Current vs. Temperature  
( $V^+=5V$ )

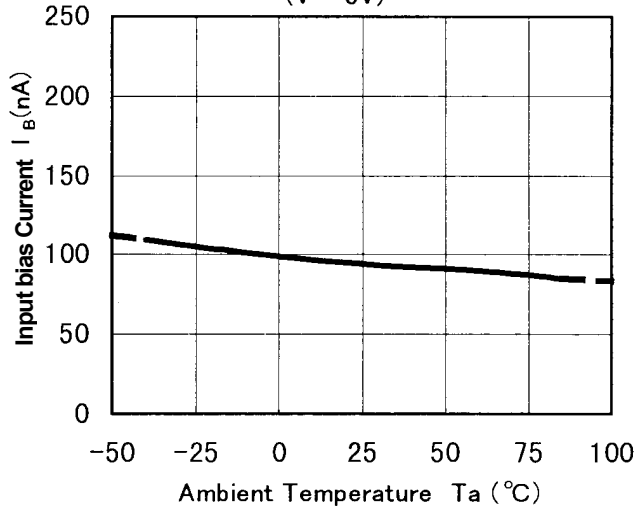

Maximum Output Voltage Swing vs. Temperature  
( $V^+=5V, R_L=2k\Omega$ )

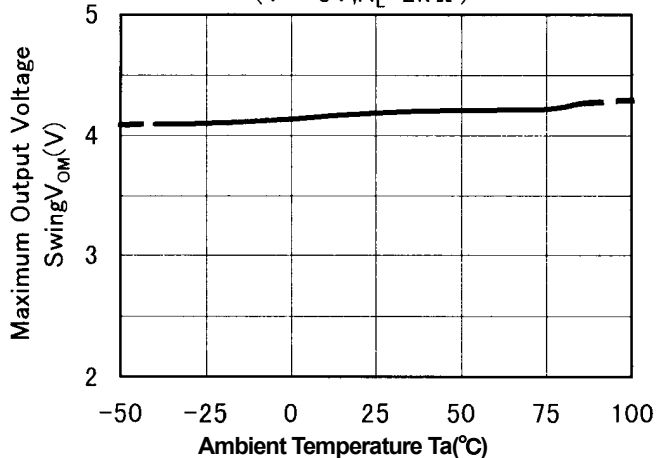

**[CAUTION]**

The specifications on this databook are only given for information, without any guarantee as regards either mistakes or omissions. The application circuits in this databook are described only to show representative usages of the product and not intended for the guarantee or permission of any right including the industrial rights.