

ISO VIEW
SCALE 1:1

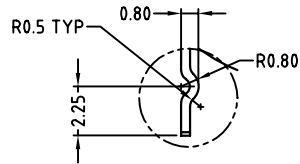

DETAIL A
SCALE 4:1

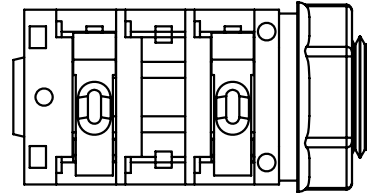
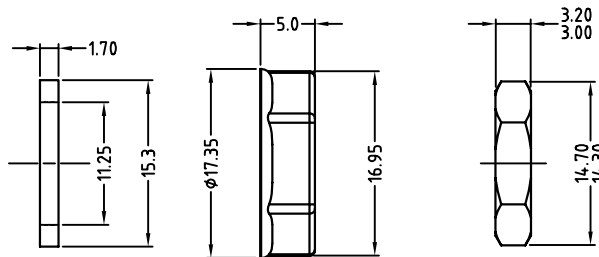
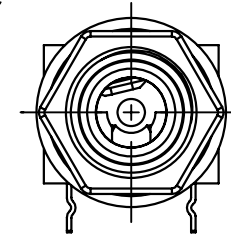
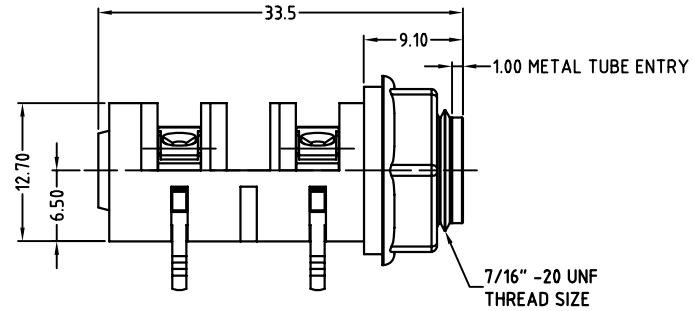
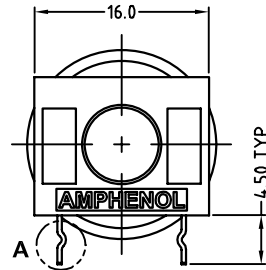

FIBER WASHER

PLASTIC NUT

METAL NUT

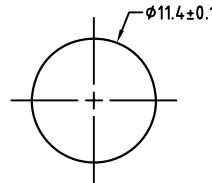

PANEL CUTOUT

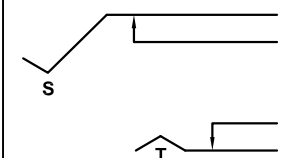

SCHEMATIC

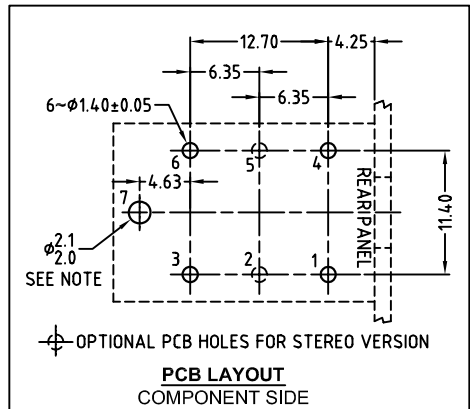

PCB LAYOUT
COMPONENT SIDE

CATALOGUE P/N	ASSEMBLY P/N	NUT OPTIONS
ACJM-PHDR	55010153-502	PLASTIC
ACJM-MHDR	55010153-302	METAL

NOTE: OPTIONAL MOUNTING HOLE FOR SELF-TAPPING M2 SCREW

UNLESS OTHERWISE SPECIFIED TOLERANCE TO BE

LINEAR	ANGULAR
X ± 0.5	X° ± 1°
XX ± 0.1	X°X' ± 30'
XXX ± 0.05	X°X'X'' ± 15'

BREAK ALL SHARP EDGES AND REMOVE ALL BURRS

DO NOT SCALE

DIMENSIONS IN MILLIMETRES

THIS DOCUMENT IS THE PROPERTY OF AMPHENOL AUSTRALIA PTY. LTD. NO PART THEREOF MAY BE REPRODUCED AND USED WITHOUT THE PRIOR WRITTEN CONSENT OF THE OWNER

CAD FILE: 55010153502222	DRN: L.V	DATE: 18-06-02
MATL: REFER TO COMPONENTS	CKD: M.N.H	DATE: 13-02-09
FINISH: REFER TO COMPONENTS	APP'D: P.M	DATE: 13-02-09



SCALE: 2:1 UOS

REV.	CHANGE DETAILS	BY	DATE	CHG/No
3	ADD MISSING DIMENSIONS ADD WASHER & DIMENSIONS	M.H	13-02-09	8803
2	CHANGE PLASTIC NUT FROM P/N: 52170018-531 TO P/N: 52170032-531	L.V	31-01-05	8333
1	UPDATE TO COMPLY WITH MODIFIED COMPONENTS	L.V	11-06-03	8184
0	FIRST ISSUE	L.V	18-06-02	----

TITLE:
1/4" PHONE
MONO JACK
CUSTOMER DRAWING

Amphenol	
Amphenol Australia Pty Ltd, 2 Fireways Blvd, Keysborough, Vic 3173	
DRAWING NO.	SHEET
55010153-502-2	2 OF 2