

KIT P/N	HOUSING COLOR
106073-0020	BLACK
106073-0024	CLEAR

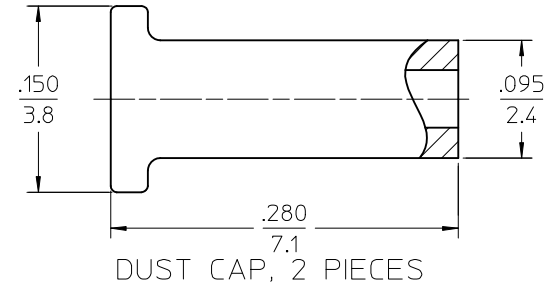

HOUSING (SCALE 8:1)

DUST CAP, 2 PIECES

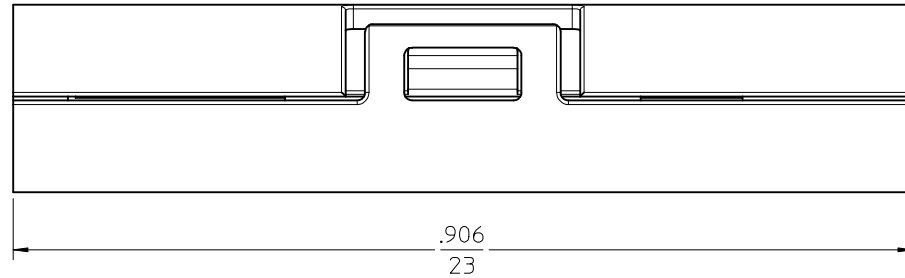
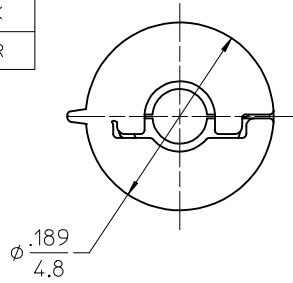
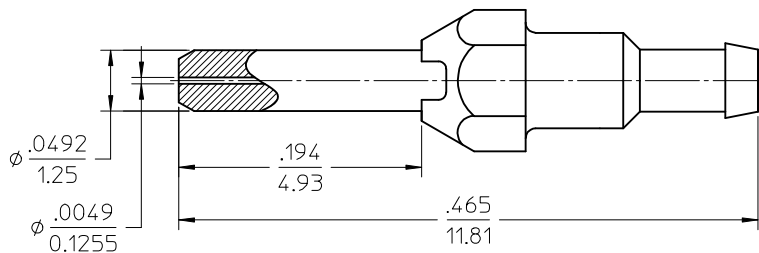

LC PLUG, METAL BODY, 2 PIECES  
(ZIRCONIA CERAMIC FERRULE)

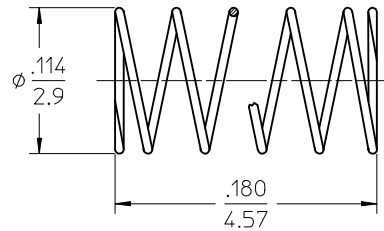

COMPRESSION SPRING  
(MUSIC WIRE)

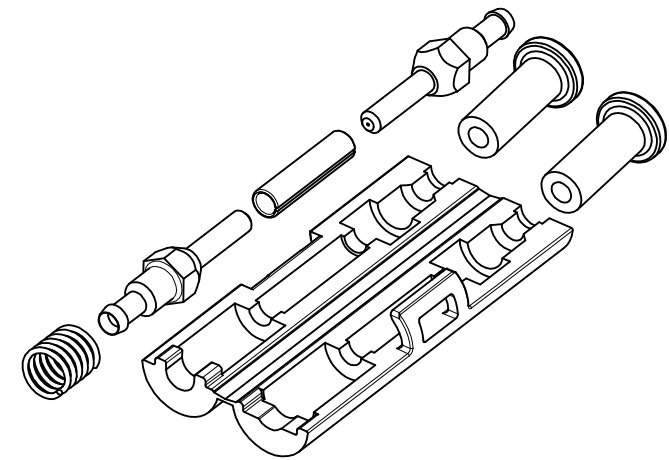

ISOMETRIC VIEW  
SCALE 4:1

NOTES:

1. ALL DIMENSIONS ARE FOR REFERENCE ONLY.
2. ALL PARTS ARE PACKED IN ONE BAG - 1 KIT PER BAG.
3. ALL PLASTIC MATERIALS ARE UL-94 V-0 RATED.

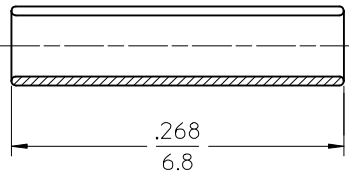
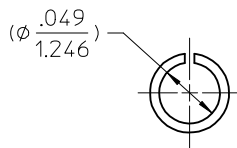

ALIGNMENT SLEEVE  
(ZIRCONIA CERAMIC)

<b>ENTER DESCRIPTION</b> EC NO: MF2009-0559 DRAWN: YBEDNYAK 2009/04/21 CHKD: 2009/04/21 APPR: LGUMIN 2009/04/21	<b>QUALITY SYMBOLS</b> ▽=0 ▽=0	<b>GENERAL TOLERANCES (UNLESS SPECIFIED)</b>		<b>DIMENSION STYLE</b> IN/MM		SCALE 10:1	DESIGN UNITS INCH	THIRD ANGLE PROJECTION		
		4 PLACES	± ---	± ---	DRAWN BY	DATE	TITLE SNAP MATE KIT (FULL)			
		3 PLACES	± ---	± ---	KP	01/25/2006				
		2 PLACES	± ---	± ---	CHECKED BY	DATE	APPROVED BY I. GUMIN 01/25/2006			
1 PLACE	± ---	± ---	ANGULAR ±1/2°		MATERIAL NO. SEE TABLE		DOCUMENT NO. SD-106073-0020		SHEET NO. 1 OF 1	
DRAFT WHERE APPLICABLE MUST REMAIN WITHIN DIMENSIONS			MOLEX INCORPORATED							
THIS DRAWING CONTAINS INFORMATION THAT IS PROPRIETARY TO MOLEX INCORPORATED AND SHOULD NOT BE USED WITHOUT WRITTEN PERMISSION										