



**SPECIFICATION SHEET**

<b>SPECIFICATION SHEET NO.</b>	N0929- SOD323007WSSD7
<b>DATE</b>	Sept. 29, 2021
<b>REVISION</b>	A0
<b>DESCRIPTION</b>	<p>SMD General Purpose Silicon Rectifier, SOD-323 series,            1N4007WS Type, 2 Pads</p> <p>Reverse Voltage 1000V Max. Forward Current 1.0A Max.</p> <p>Operating Temp. Range -55°C ~+150°C</p> <p>Package in Tape/Reel, 3000pcs/Reel</p> <p>RoHS/RoHS III compliant</p>
<b>CUSTOMER</b>	
<b>CUSTOMER PART NUMBER</b>	
<b>CROSS REF. PART NUMBER</b>	
<b>ORIGINAL PART NUMBER</b>	MDD 1N4007WS
<b>PART CODE</b>	SOD323007WSSD7

<b>VENDOR APPROVE</b>			
Issued/Checked/Approved			
DATE: Sept. 29, 2021			

<b>CUSTOMER APPROVE</b>	
DATE:	

**SMD GENERAL PURPOSE RECTIFER SOD323 SERIES**



**MAIN FEATURE**

- Glass passivated device
- Low reverse leakage
- Metallurgically bonded construction
- High temperature soldering guaranteed: 250°C/ 10 seconds at terminals

**APPLICATION**

- For printed circuit board

**RFQ**

[Request For Quotation](#)

**PART CODE GUIDE**

SOD323	007WS	S	D7
1	2	3	4

1) **SOD323**: SMD General Purpose Silicon Rectifier, SOD-323 series,

2) **4007**: Type Code for original part number 1N4007WS

3) **S**: Package code, Tape/reel, 3000pcs/reel.

4) **D7**: Marking code for "D7" on the case surface, Different Marking for different specification..

**MORE ITEMS AVAILABLE**

SOD323001WSSD1	SOD323002WSSD2	SOD323003WSSD3	SOD323004WSSD4	SOD323005WSSD5
SOD323006WSSD6	<b>SOD323007WSSD7</b>			

**SMD GENERAL PURPOSE RECTIFIER SOD323 SERIES**

**DIMENSION (Unit: Inch/mm)**

Image for reference



Marking: D7

SOD-323

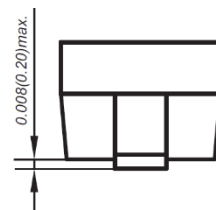
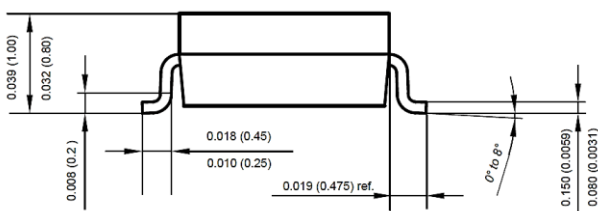
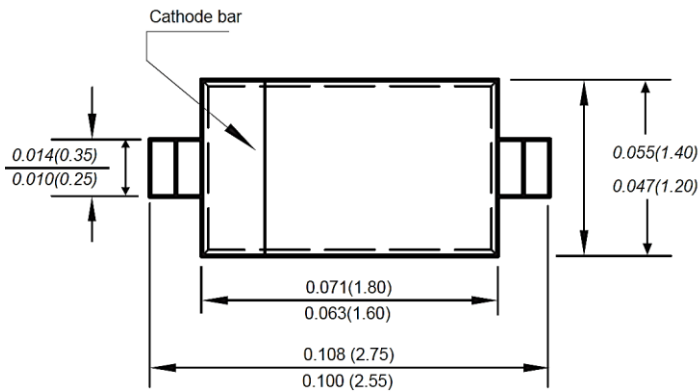

Recommend Pad Layout

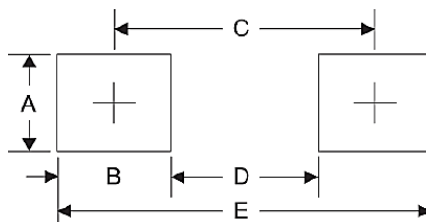

Symbol	Unit (inch)	Unit (mm)
A	0.047	1.2
B	0.047	1.2
C	0.102	2.6
D	0.055	1.4
E	0.149	3.8

**SMD GENERAL PURPOSE RECTIFIER SOD323 SERIES**
**MECHANICAL DATA**

Case	Terminals	Polarity	Mounting Position	Weight per piece
JEDEC SOD-323 molded plastic body	Solder plated, Solderable per MIL-STD-750, Method 2026	Polarity symbol marking on case	Any	0.00019 Ounce, 0.00548 grams

**MAX. RATING & CHARACTERISTICS**

Parameter	SYMBOLS	VALUE			UNITS
		Min.	Typical	Max.	
<b>Repetitive peak reverse voltage</b>	V <sub>RRM</sub>			1000	Volts
<b>RMS voltage</b>	V <sub>RMS</sub>			700	Volts
<b>DC blocking voltage</b>	V <sub>DC</sub>			1000	Volts
<b>Average forward output rectified current</b>	I <sub>AV</sub>			1.0	A
<b>Peak forward surge current 8.3ms single half sine-wave superimposed on rated load (JEDEC Method)</b>	I <sub>FSM</sub>			25	A
<b>Instantaneous forward voltage at 1.0A</b>	V <sub>F</sub>			1.1	Volts
<b>DC reverse current at rated DC blocking voltage</b>	I <sub>R</sub>			5.0	μA
				50	μA
<b>Junction capacitance (Note 3)</b>	C <sub>J</sub>		5		pF
<b>Thermal resistance (Note 4)</b>	R <sub>QJA</sub>		55.0		°C/W
<b>Operating junction temperature range</b>	T <sub>J</sub>	-55		+150	°C
<b>Storage temperature range</b>	T <sub>STG</sub>	-55		+150	°C

**Note**

- Ratings at 25 C ambient temperature unless otherwise specified. Single phase half-wave 60Hz, resistive or inductive load, for capacitive load current derate by 20%.
- Reverse recovery condition IF=0.5A, IR=1.0A, Irr=0.25A
- Measured at 1.0MHz and applied reverse voltage of 4.0Voltage
- P.C.B. mounted with 0.2x0.2"(5.0x5.0mm) copper pad areas.

**SMD GENERAL PURPOSE RECTIFIER SOD323 SERIES**
**RELIABILITY**

Number	Experiment Items	Experiment Method And Conditions	Reference Documents
1	Solder Resistance Test	Test 260°C± 5°C for 10 ± 2 sec. Immerse body into solder 1/16" ± 1/32"	MIL-STD-750D METHOD-2031.2
2	Solderability Test	230°C ±5°C for 5 sec.	MIL-STD-750D METHOD-2026.1 0
3	Pull Test	1 kg in axial lead direction for 10 sec.	MIL-STD-750D METHOD-2036.4
4	Bend Test	0.5Kg Weight Applied To Each Lead, Bending Arcs 90 °C ± 5 °C For 3 Times	MIL-STD-750D METHOD-2036.4
5	High Temperature Reverse Bias Test	TA=100°C for 1000 Hours at VR=80% Rated VR	MIL-STD-750D METHOD-1038.4
6	Forward Operation Life Test	TA=25°C Rated Average Rectified Current	MIL-STD-750D METHOD-1027.3
7	Intermittent Operation Life Test	On state: 5 min with rated IRMS Power Off state: 5 min with Cool Forced Air. On and off for 1000 cycles.	MIL-STD-750D METHOD-1036.3
8	Pressure Cooker Test	15 PSIG, TA=121°C, 4 hours	MIL-S-19500 APPENOIXC
9	Temperature Cycling Test	-55°C~+125°C; 30 Minutes For Dwelled Time 5 minutes for transferred time. Total: 10 cycles.	MIL-STD-750D METHOD-1051.7
10	Thermal Shock Test	0°C for 5 minutes., 100°C for 5minutes, Total: 10 cycles	MIL-STD-750D METHOD-1056.7
11	Forward Surge Test	8.3ms Single Sale Sine-wave One Surge.	MIL-STD-750D METHOD-4066.4
12	Humidity Test	TA=65°C, RH=98% for 1000 hours.	MIL-STD-750D METHOD-1021.3
13	High Temperature Storage life Test	150°C for 1000 Hours	MIL-STD-750D METHOD-1031.5

**SMD GENERAL PURPOSE RECTIFIER SOD323 SERIES**

**SUGGESTED REFLOW PROFILE (For Reference Only)**

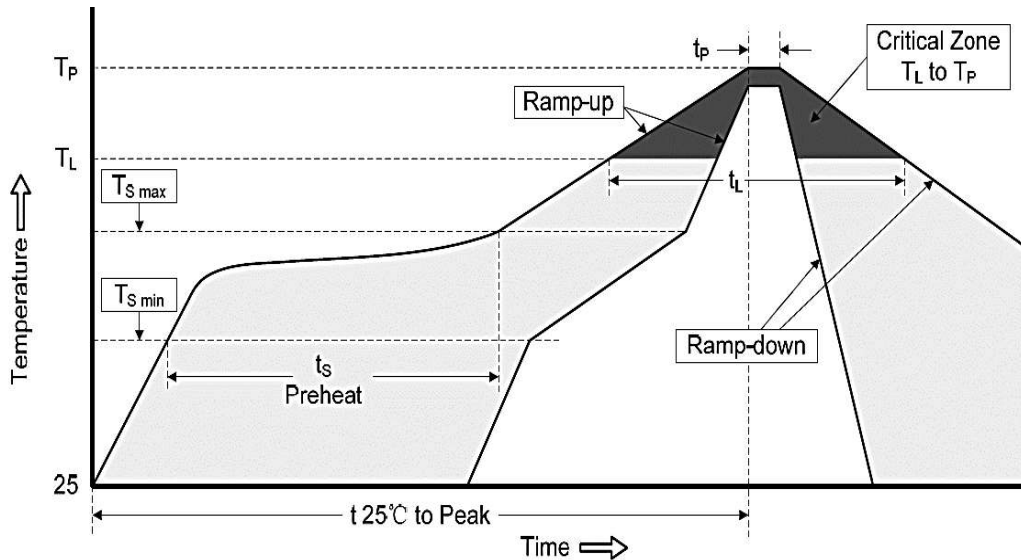

<b>Profile Feature</b>		Pb-Free Assembly
<b>Average Ramp-up Rate (Ts Max to Tp)</b>		3°C/second Max
<b>Preheat</b>	<b>Temperature Min (Ts Min.)</b>	150°C
	<b>Temperature Max (Ts Max.)</b>	200°C
	<b>Time (ts Min. to ts Max.)</b>	60 ~ 180 seconds
<b>Time maintained above</b>	<b>Temperature (Tl)</b>	217°C
	<b>Time (tl)</b>	60 ~ 150 seconds
<b>Peak/Classification Temperature (Tp)</b>		260 °C
<b>Time within 5°C of actual Peak Temperature (tp)</b>		20 ~ 40 seconds
<b>Ramp-down rate</b>		6 °C /Second Max.
<b>Time 25 °C to Peak Temperature</b>		8 minutes Max.
<b>Suggest reflow times</b>		3 Times Max.

**SMD GENERAL PURPOSE RECTIFIER SOD323 SERIES**

**RATINGS AND CHARACTERISTIC CURVES (For Reference Only)**

Fig.1 Forward Current Derating Curve

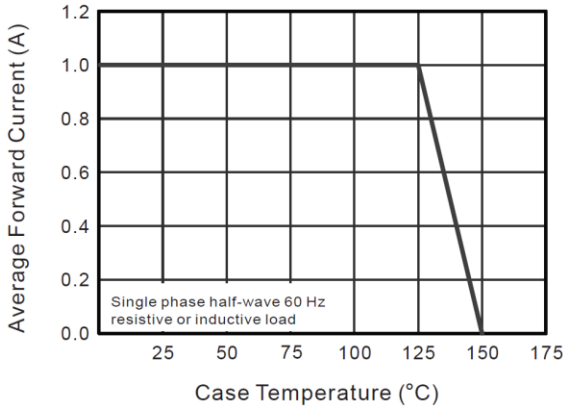

Fig.2 Typical Instantaneous Reverse Characteristics

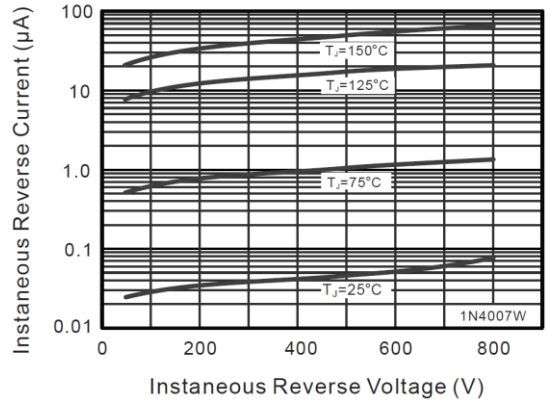

Fig.3 Typical Forward Characteristic

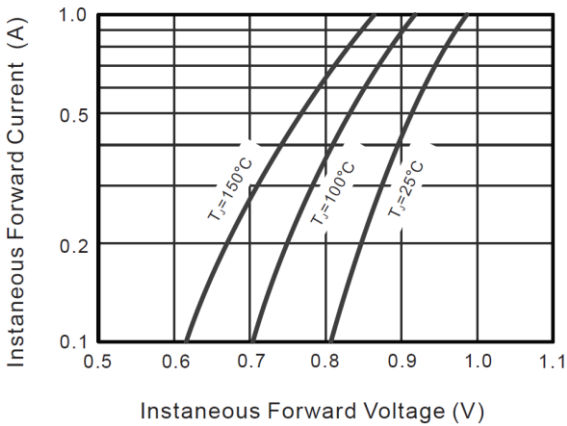

Fig.4 Typical Junction Capacitance

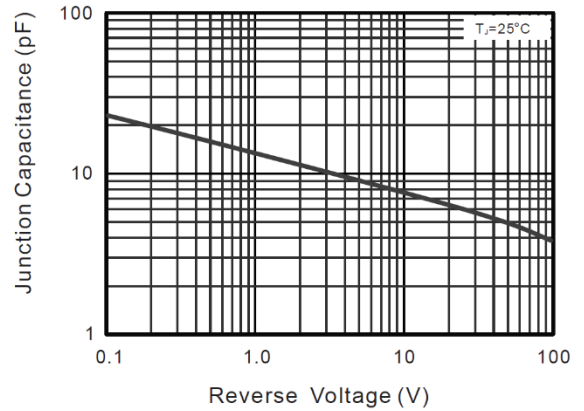
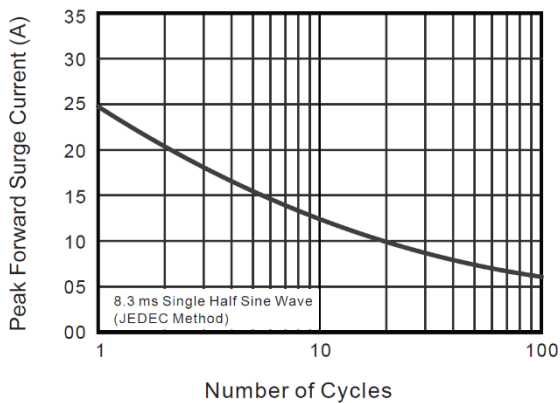

Fig.5 Maximum Non-Repetitive Peak Forward Surge Current



**SMD GENERAL PURPOSE RECTIFIER SOD323 SERIES**

**TAPE/REEL (Unit: mm)**

All Devices are packed in accordance with EIA standard RS-481-A and specifications.

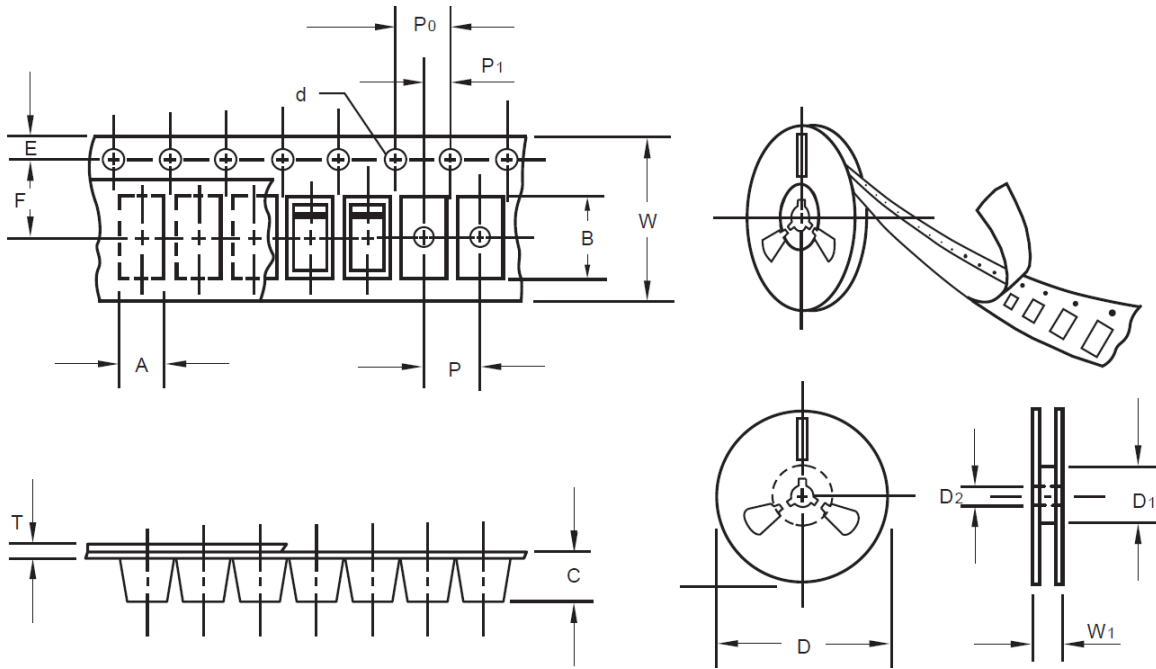

Item	Symbol	Tolerance	SO-323
Carrier width	A	0.1	1.46
Carrier Length	B	0.1	2.90
Carrier Depth	C	0.1	1.25
Sprocket hole	d	0.05	1.55
7"Reel outside diameter	D	2.0	178.00
7"Reel inner diameter	D1	Min.	50.00
Feed hole diameter	D2	0.5	13.00
Sprocket hole position	E	0.1	1.75
Punch hole position	F	0.1	3.50
Punch hole pitch	P	0.1	4.00
Sprocket hole pitch	P0	0.1	4.00
Embossment center	P1	0.1	2.00
Overall tape thickness	T	0.1	0.06
Tape width	W	0.3	8.00
Reel width	W1	1.0	12.30



**SMD GENERAL PURPOSE RECTIFER SOD323 SERIES**

**SPQ PACKAGE for Reference**

Item	Unit	Value
Case Code		SOD-323
Reel Size	Inch	7
Reel Size	mm	178
Tape Space	mm	/
SPQ /Reel	pcs	3000
Weigh /SPQ	LBS	0.88
Weigh /SPQ	KGs	0.40
Qty. Per Box	pcs	6,000
Inner Box	Inch	L8.0*W8.0*H1.5

**DISCLAIMER**

NextGen Component, Inc. reserves the right to make changes to the product(s) and or information contained herein without notice. No liability is assumed as a result of their use or application. No rights under any patent accompany the sale of any such product(s) or information