

# LM10

Related Information

- General terms and conditions..... F-17
- Sensor selection guide ..... P.967~
- Glossary of terms / General precautions...P.1397 / P.1405
- About laser beam.....P.1403~

- FIBER SENSORS
- LASER SENSORS
- PHOTOELECTRIC SENSORS
- MICRO PHOTOELECTRIC SENSORS
- AREA SENSORS
- LIGHT CURTAINS
- PRESSURE / FLOW SENSORS
- INDUCTIVE PROXIMITY SENSORS
- PARTICULAR USE SENSORS
- SENSOR OPTIONS
- SIMPLE WIRE-SAVING UNITS
- WIRE-SAVING SYSTEMS
- MEASUREMENT SENSORS**
- STATIC CONTROL DEVICES
- ENDOSCOPE
- LASER MARKERS
- PLC / TERMINALS
- HUMAN MACHINE INTERFACES
- ENERGY CONSUMPTION VISUALIZATION COMPONENTS
- FA COMPONENTS
- MACHINE VISION SYSTEMS
- UV CURING SYSTEMS



[panasonic-electric-works.net/sunx](http://panasonic-electric-works.net/sunx)



Conforming to EMC Directive



Conforming to FDA regulations (ANR11□□1 and ANR12□□1 only)

This product is classified as a Class 1 / Class 2 Laser Product in IEC / JIS standards and a Class II Laser Product in FDA regulations. Do not look at the laser beam directly or through optical system such as a lens.

## Micron order displacement measurement with photoelectric sensor sensitivity!

### High-precision measurements, comparative output (amount of light / displacement) function

In addition to conventional analog output, it is equipped with standard ON / OFF control output (single / double comparator) enabling its use as a photoelectric sensor. It is compatible for "micro-spotting" and "high-precision" applications normally reserved for lasers.

#### Setting modes and types of ON / OFF control

| Type              | Standard mode                      | Intensity mode                      |
|-------------------|------------------------------------|-------------------------------------|
| Window comparator | Distance judgment (3 value output) | No mode setting                     |
| Single comparator | Distance judgment (2 value output) | Intensity judgment (2 value output) |

Distance judgment: ON / OFF control on the basis of distance measurement.  
Intensity judgment: ON / OFF control on the basis of received light level.

#### Measurement principle of LM10 (optical triangulation)

Part of the light rays which come from the target object by means of diffuse reflection produce a light spot on the position sensing device (PSD). This light spot varies depending on the displacement of the target object. By measuring the fluctuations in the light spot, LM10 can measure the distance of the target object.

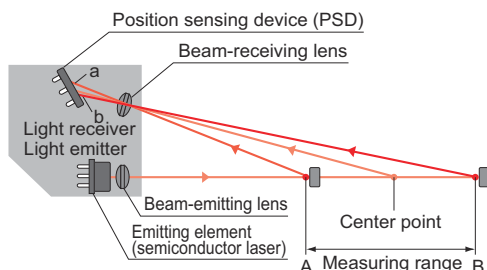

### New circuitry lowers costs

LM10 uses the single-channel IC, which reduces the dual-channel processing requirement of conventional products to a single channel. Building the arithmetic circuits into the IC has made it possible to reduce costs.

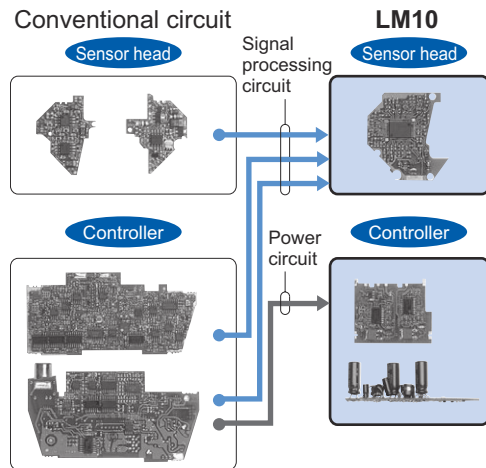

### The LM10's cost-performance ratio far outstrips the competition

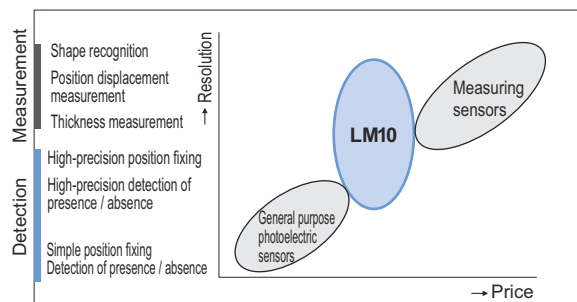

- Selection Guide
- Laser Displacement
- Magnetic Displacement
- Collimated Beam
- Digital Panel Controller
- Metal-sheet
- Double-feed Detection

HL-G1

HL-C2

HL-C1

**LM10**

**APPLICATIONS**

**Measuring packing-tape thickness**

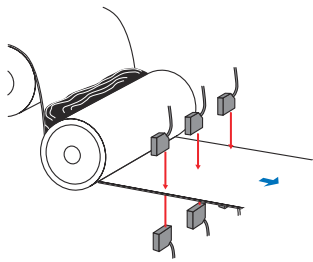

**Slack detection**

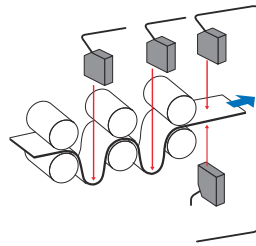

**Measuring board thickness**

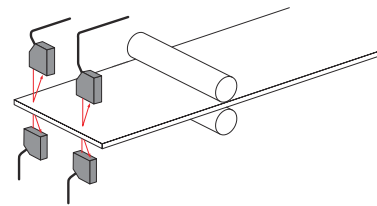

**Wood surface form detection**

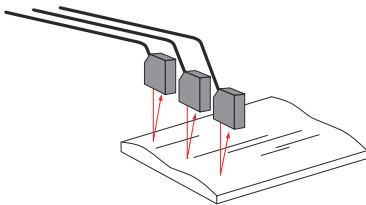

**Construction material overlap detection**

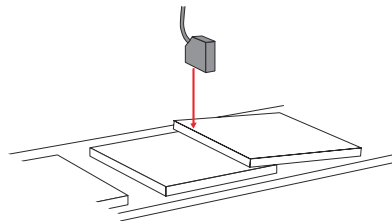

**Asymmetry detection**

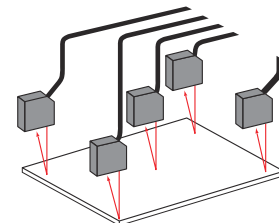

**BASIC PERFORMANCE**

**Use LM10 with confidence. It meets for Class 1 laser safety (IEC standards)**

In addition to our laser Class 2 products, a full line of Class 1 products have been added. Development of a high-precision aspheric surface plastic lens has made it possible to maintain both high precision and Class 1 safety. The visible light spot makes it easy to see and safe to use.

**Globally usable**

This micro laser sensor **LM10** comply with the requirements of the relevant EC Directives (CE marking). Not only can they work well in devices made for European industry but also possess enhanced electromagnetic environment performance making them safe to use. For the controller's comparative output, in addition to the NPN transistor output, the PNP transistor output is also available.



**VARIETIES**

**Interchangeable sensor heads**

18 models of sensor heads and 4 models of controllers can be freely combined in 72 different ways. Unlike with conventional sensors, these heads and controllers are completely interchangeable to meet any type of measuring and processing requirements, so there is no need for pair management of heads and controllers.

**Excellent in the following circumstances...**

• **When carrying out repairs**



Suppose an accident on the production line damages the sensor head.



**With the micro laser displacement sensor LM10...**



...all you have to do is replace the sensor head. As long as there is a spare sensor available, the problem can be solved without stopping the production line.

• **When changing to a different model**



Suppose that after purchasing the sensor it becomes necessary to switch to a different model due to changes in the object you are measuring.



**With the micro laser displacement sensor LM10...**



...all you have to do is buy a new sensor head. The current controller need not be replaced.

FIBER SENSORS

LASER SENSORS

PHOTOELECTRIC SENSORS

MICRO PHOTOELECTRIC SENSORS

AREA SENSORS

LIGHT CURTAINS

PRESSURE / FLOW SENSORS

INDUCTIVE PROXIMITY SENSORS

PARTICULAR USE SENSORS

SENSOR OPTIONS

SIMPLE WIRE-SAVING UNITS

WIRE-SAVING SYSTEMS

MEASUREMENT SENSORS

STATIC CONTROL DEVICES

ENDOSCOPE

LASER MARKERS

PLC / TERMINALS

HUMAN MACHINE INTERFACES

ENERGY CONSUMPTION VISUALIZATION COMPONENTS

FA COMPONENTS

MACHINE VISION SYSTEMS

UV CURING SYSTEMS

Selection Guide

Laser Displacement

Magnetic Displacement

Collimated Beam

Digital Panel Controller

Metal-sheet Double-feed Detection

HL-G1

HL-C2

HL-C1

**LM10**

**ORDER GUIDE**

**Sensor heads**

| Laser class | Type            | Measuring range                    | Resolution              | Spot diameter                          | Model No.                     |                                 |
|-------------|-----------------|------------------------------------|-------------------------|--|-------------------------------|---------------------------------|
|             |                 |                                    |                         |  | IEC standards conforming type | FDA regulations conforming type |
| Class 1     | <b>LM10-50</b>  | 50 ±10 mm <b>1.969 ±0.394 in</b>   | 5 μm <b>0.197 mil</b>   | 0.6 × 1.1 mm <b>0.024 × 0.043 in</b>   | ANR1150                       | ANR11501                        |
|             | <b>LM10-50S</b> | 50 ±10 mm <b>1.969 ±0.394 in</b>   | 5 μm <b>0.197 mil</b>   | 0.09 × 0.05 mm <b>0.004 × 0.002 in</b> | ANR1151                       | ANR11511                        |
|             | <b>LM10-80</b>  | 80 ±20 mm <b>3.150 ±0.787 in</b>   | 20 μm <b>0.787 mil</b>  | 0.7 × 1.2 mm <b>0.023 × 0.047 in</b>   | ANR1182                       | ANR11821                        |
|             | <b>LM10-130</b> | 130 ±50 mm <b>5.118 ±1.969 in</b>  | 100 μm <b>3.937 mil</b> | 0.7 × 1.4 mm <b>0.028 × 0.055 in</b>   | ANR1115                       | ANR11151                        |
| Class 2     | <b>LM10-50</b>  | 50 ±10 mm <b>1.969 ±0.394 in</b>   | 1 μm <b>0.039 mil</b>   | 0.6 × 1.1 mm <b>0.024 × 0.043 in</b>   | ANR1250                       | ANR12501                        |
|             | <b>LM10-50S</b> | 50 ±10 mm <b>1.969 ±0.394 in</b>   | 1 μm <b>0.039 mil</b>   | 0.09 × 0.05 mm <b>0.004 × 0.002 in</b> | ANR1251                       | ANR12511                        |
|             | <b>LM10-80</b>  | 80 ±20 mm <b>3.150 ±0.787 in</b>   | 4 μm <b>0.157 mil</b>   | 0.7 × 1.2 mm <b>0.028 × 0.047 in</b>   | ANR1282                       | ANR12821                        |
|             | <b>LM10-130</b> | 130 ±50 mm <b>5.118 ±1.969 in</b>  | 20 μm <b>0.787 mil</b>  | 0.7 × 1.4 mm <b>0.028 × 0.055 in</b>   | ANR1215                       | ANR12151                        |
|             | <b>LM10-250</b> | 250 ±150 mm <b>9.843 ±5.906 in</b> | 150 μm <b>5.906 mil</b> | 0.8 × 1.5 mm <b>0.031 × 0.059 in</b>   | ANR1226                       | ANR12261                        |

**Controllers**

|            | Output                  | Specifications             | Model No. |
|------------|-------------------------|----------------------------|-----------|
| Controller | ±5 V                    | Built-in single comparator | ANR5131   |
|            |                         | Built-in window comparator | ANR5231   |
|            | 4 to 20 mA (NPN output) | Built-in single comparator | ANR5141   |
|            |                         | Built-in window comparator | ANR5241   |

Note: NPN and PNP outputs are coordinated as per all the models' comparative outputs.

**Extension cable (for sensor Class 2 types only) for connection to the intermediate cable** (1.5 m **4.921 ft** intermediate cable is supplied with Class 2 type sensor heads)

| Designation                      | Specifications                     | Model No. |
|----------------------------------|------------------------------------|-----------|
| Extension cable (Flexible cable) | 2 m <b>6.562 ft</b> cable length   | ANR81020  |
|                                  | 3 m <b>9.843 ft</b> cable length   | ANR81030  |
|                                  | 5 m <b>16.404 ft</b> cable length  | ANR81050  |
|                                  | 8 m <b>26.247 ft</b> cable length  | ANR81080  |
|                                  | 10 m <b>32.808 ft</b> cable length | ANR81100  |
|                                  | 20 m <b>65.617 ft</b> cable length | ANR81200  |
|                                  | 30 m <b>98.425 ft</b> cable length | ANR81300  |

**SENSOR HEAD AND CONTROLLER ASSEMBLY**

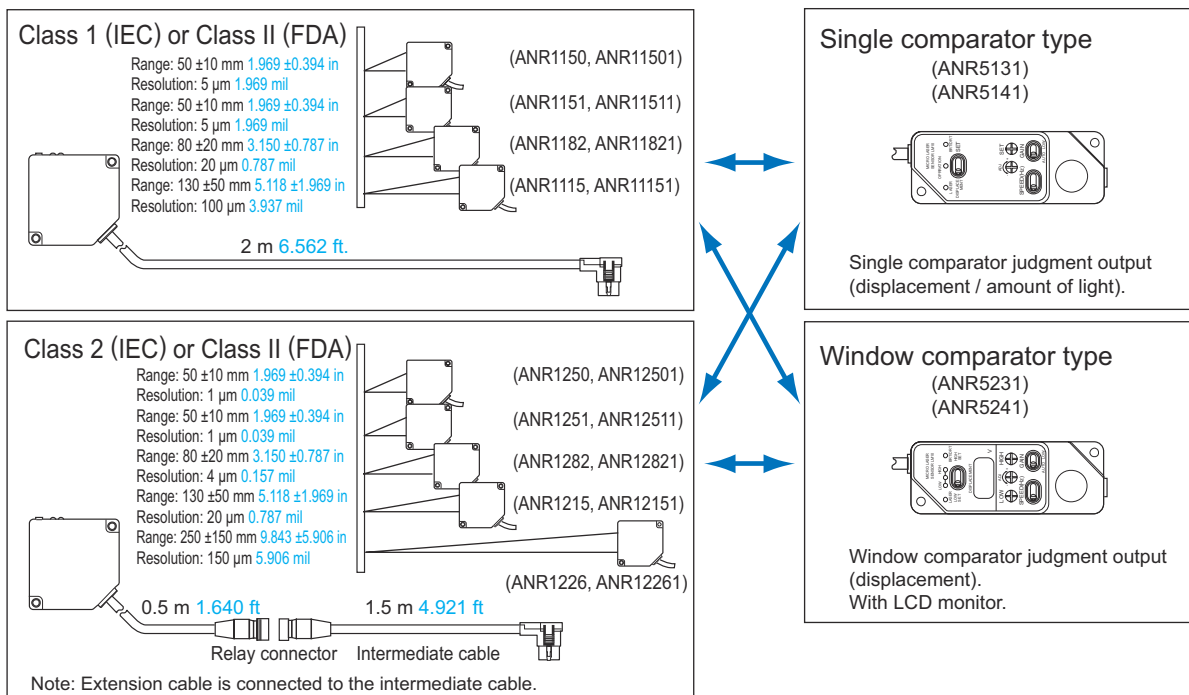

**SPECIFICATIONS****Sensor heads****Class 1 type**

| Item   | Model No.                              | IEC standards conforming type   | ANR1150  | ANR1151  | ANR1182  | ANR1115  |
|--|--|---|--|--|--|--|
|  |  | FDA regulations conforming type   | ANR11501   | ANR11511   | ANR11821   | ANR11151   |
| Measurement center distance  |  |   | 50 mm <b>1.969 in</b>                              | 50 mm <b>1.969 in</b>                                | 80 mm <b>3.150 in</b>                              | 130 mm <b>5.118 in</b>                             |
| Measuring range  |  |   | ±10 mm <b>±0.394 in</b>                            | ±10 mm <b>±0.394 in</b>                              | ±20 mm <b>±0.787 in</b>                            | ±50 mm <b>±1.969 in</b>                            |
| Light source   |  | Laser diode (Peak emission wavelength: 650 nm <b>0.026 mil</b> )  |  |  |  |  |
|  | Pulse width / Max.output / Laser class | 15 µs (Duty 50 %) / 0.4 mW (Peak value) / Class 1 (IEC 60825-1), (Class II for FDA regulations conforming type) |  |  |  |  |
| Beam spot diameter<br>(Representative values from a measurement center distance) |  |   | 0.6 × 1.1 mm<br><b>0.024 × 0.043 in</b><br>approx. | 0.09 × 0.05 mm<br><b>0.004 × 0.002 in</b><br>approx. | 0.7 × 1.2 mm<br><b>0.028 × 0.047 in</b><br>approx. | 0.7 × 1.4 mm<br><b>0.028 × 0.055 in</b><br>approx. |
| Resolution (2 σ)   | 10Hz                                   |   | 5 µm <b>0.197 mil</b>                              | 5 µm <b>0.197 mil</b>                                | 20 µm <b>0.787 mil</b>                             | 100 µm <b>03.937 mil</b>                           |
|  | 100Hz                                  |   | 16 µm <b>0.630 mil</b>                             | 16 µm <b>0.630 mil</b>                               | 65 µm <b>2.559 mil</b>                             | 330 µm <b>12.992 mil</b>                           |
|  | 1kHz                                   |   | 50 µm <b>1.969 mil</b>                             | 50 µm <b>1.969 mil</b>                               | 200 µm <b>7.874 mil</b>                            | 1 mm <b>00.039 in</b>                              |
| Linearity error (Note 2)   |  | Within ±0.2 % of F.S.   |  |  |  |  |
| Protection (excluding connector)   |  | IP67 (IEC)  |  |  |  |  |
| Ambient illuminance<br>(Incandescent lamp)                                       |  | 2,500 lx or less  |  |  |  |  |
| Weight (including cable)   |  | Net weight: 300 g approx.   |  |  |  |  |

Notes: 1) Where measurement conditions have not been specified precisely, the conditions used were an ambient temperature of +20 °C +68 °F.  
2) White ceramics is the target of this value.

**Class 2 type**

| Item   | Model No.                              | IEC standards conforming type   | ANR1250  | ANR1251  | ANR1282  | ANR1215  | ANR1226  |
|--|--|---|--|--|--|--|--|
|  |  | FDA regulations conforming type   | ANR12501   | ANR12511   | ANR12821   | ANR12151   | ANR12261   |
| Measurement center distance  |  |   | 50 mm <b>1.969 in</b>                              | 50 mm <b>1.969 in</b>                                | 80 mm <b>3.150 in</b>                              | 130 mm <b>5.118 in</b>                             | 250 mm <b>9.843 in</b>                             |
| Measuring range  |  |   | ±10 mm <b>±0.394 in</b>                            | ±10 mm <b>±0.394 in</b>                              | ±20 mm <b>±0.787 in</b>                            | ±50 mm <b>±1.969 in</b>                            | ±150 mm <b>±5.906 in</b>                           |
| Light source   |  | Laser diode (Peak emission wavelength: 650 nm <b>0.026 mil</b> )  |  |  |  |  |  |
|  | Pulse width / Max.output / Laser class | 15 µs (Duty 50 %) / 1.6 mW (Peak value) / Class 2 (IEC 60825-1), (Class II for FDA regulations conforming type) |  |  |  |  |  |
| Beam spot diameter<br>(Representative values from a measurement center distance) |  |   | 0.6 × 1.1 mm<br><b>0.024 × 0.043 in</b><br>approx. | 0.09 × 0.05 mm<br><b>0.004 × 0.002 in</b><br>approx. | 0.7 × 1.2 mm<br><b>0.028 × 0.047 in</b><br>approx. | 0.7 × 1.4 mm<br><b>0.028 × 0.055 in</b><br>approx. | 0.8 × 1.5 mm<br><b>0.031 × 0.059 in</b><br>approx. |
| Resolution (2 σ)   | 10Hz                                   |   | 1 µm <b>0.039 mil</b>                              | 1 µm <b>0.039 mil</b>                                | 4 µm <b>0.157 mil</b>                              | 20 µm <b>0.787 mil</b>                             | 150 µm <b>5.906 mil</b>                            |
|  | 100Hz                                  |   | 3.5 µm <b>0.138 mil</b>                            | 3.5 µm <b>0.138 mil</b>                              | 13 µm <b>0.512 mil</b>                             | 65 µm <b>2.551 mil</b>                             | 500 µm <b>19.685 mil</b>                           |
|  | 1kHz                                   |   | 10 µm <b>0.394 mil</b>                             | 10 µm <b>0.394 mil</b>                               | 40 µm <b>1.575 mil</b>                             | 200 µm <b>7.874 mil</b>                            | 1.5 mm <b>0.059 in</b>                             |
| Linearity error (Note 2)   |  | Within ±0.2 % of F.S.   |  |  |  |  | Within ±0.4 % of F.S.                              |
| Protection (excluding connector)   |  | IP67 (IEC)  |  |  |  |  |  |
| Ambient illuminance<br>(Incandescent lamp)                                       |  | 3,000 lx or less  |  |  |  |  | 2,500 lx or less                                   |
| Weight   |  | Net weight: Sensor head (including cable): 240 g approx., Intermediate cable: 130 g approx.                     |  |  |  |  |  |

Notes: 1) Where measurement conditions have not been specified precisely, the conditions used were an ambient temperature of +20 °C +68 °F.  
2) White ceramics is the target of this value.

FIBER  
SENSORSLASER  
SENSORSPHOTO-  
ELECTRIC  
SENSORSMICRO  
PHOTO-  
ELECTRIC  
SENSORSAREA  
SENSORSLIGHT  
CURTAINSPRESSURE /  
FLOW  
SENSORSINDUCTIVE  
PROXIMITY  
SENSORSPARTICULAR  
USE  
SENSORSSENSOR  
OPTIONSSIMPLE  
WIRE-SAVING  
UNITSWIRE-SAVING  
SYSTEMSMEASURE-  
MENT  
SENSORSSTATIC  
CONTROL  
DEVICES

ENDOSCOPE

LASER  
MARKERSPLC /  
TERMINALSHUMAN  
MACHINE  
INTERFACESENERGY  
CONSUMPTION  
VISUALIZATION  
COMPONENTSFA  
COMPONENTSMACHINE  
VISION  
SYSTEMSUV  
CURING  
SYSTEMSSelection  
GuideLaser  
DisplacementMagnetic  
DisplacementCollimated  
BeamDigital Panel  
ControllerMetal-sheet  
Double-feed  
Detection**HL-G1****HL-C2****HL-C1****LM10**

## SPECIFICATIONS

### Controllers

| Model No.                                       | ANR5131   | ANR5141                      | ANR5231  | ANR5241                      |
|---|---|------------------------------|--|------------------------------|
| Item  | Single comparator   |                              | Window comparator  |                              |
| Comparative output type                         | Single comparator   |                              | Window comparator  |                              |
| Analog output                                   | ±5 V/F.S. (2 mA max.)   | 4 to 20 mA/F.S. (250 Ω max.) | ±5 V/F.S. (2 mA max.)  | 4 to 20 mA/F.S. (250 Ω max.) |
| Output impedance                                | 50 Ω  | ————                         | 50 Ω   | ————                         |
| Zero-point adjustment                           | Within ±10 % of F.S.  |                              |  |                              |
| Temperature drift (Sensor and controller set)   | Within ±(0.03 % of F.S.) /°C  | Within ±(0.04 % of F.S.) /°C | Within ±(0.03 % of F.S.) /°C   | Within ±(0.04 % of F.S.) /°C |
| Response frequency (–3 dB)                      | 1 kHz / 100 Hz / 10 Hz  |                              |  |                              |
| Response time (10 to 90 %)                      | 0.4 ms / 4 ms / 40 ms (switchable)  |                              |  |                              |
| Comparative output (Note 2)                     | NPN open-collector 2 Nos.<br>(100 mA, 30 V DC or less, residual voltage 1.5 V or less)      |                              | NPN open-collector 3 Nos.<br>(100 mA, 30 V DC or less, residual voltage 1.5 V or less) |                              |
| Hysteresis                                      | 0.15 % of F.S. or less  |                              |  |                              |
| Alarm output                                    | NPN open-collector 1 No. (100 mA, 30 V DC or less, residual voltage 1.5 V or less) (Note 2) |                              |  |                              |
| Intensity monitor output                        | ±5 V  |                              |  |                              |
| Comparative timing Input                        | No voltage input (when earthing, no comparative output allowed)                             |                              |  |                              |
| Displacement display                            | Sensor head: Measuring range display LED (RANGE)  |                              | Sensor head: Measuring range display LED (RANGE)<br>Controller: LCD 3 digit display    |                              |
| Gain selection                                  | AUTO / LOW (switchable)   |                              |  |                              |
| Mutual interference prevention (Note 3)         | Between 2 sets  |                              |  |                              |
| Operating voltage range                         | 12 to 24 V DC $\pm 10\%$ including ripple 0.5 V (P-P)                                       |                              |  |                              |
| Current consumption (Sensor and controller set) | 250 mA or less (at 12 V DC), 125 mA or less (at 24 V DC)                                    |                              |  |                              |
| Weight (including cable)                        | Net weight: 180 g approx.   |                              |  |                              |

Notes: 1) Where measurement conditions have not been specified precisely, the conditions used were an ambient temperature of +20 °C +68 °F.

2) PNP output type is also available.

3) The value of the linearity characteristics, resolution and response time might get worse.

### Common

|   |  |
|---|--|
| Insulation resistance (Initial)           | Between external DC input and sensor metal parts (except for connector metal parts) 20 MΩ or more (at 500 V DC megger)                     |
| Voltage withstandability (Initial)        | Between external DC input and sensor metal parts (except for connector metal parts) AC 500 V 1 min.  |
| Vibration resistance (Screw installation) | 10 to 55 Hz (1 cycle/min.) double amplitude of 1.5 mm 0.059 in (controller: 0.75 mm 0.030 in), in X, Y and Z directions for two hours each |
| Shock resistance (Screw installation)     | 20 G or more, in X, Y and Z directions for three times each  |
| Ambient temperature                       | 0 to +50 °C +32 to +122 °F, Storage: –20 to +70 °C –4 to +158 °F   |
| Ambient humidity                          | 35 % to 85 % RH (No dew condensation)  |

Note: If there is no description for measurement conditions, the test is performed under operating voltage 24 V DC, ambient temperature +20 °C +68 °F, gain AUTO, response frequency 10 Hz, interference prevention OFF and white ceramics as a target at a measurement center distance.

HL-G1

HL-C2

HL-C1

LM10



**I/O CIRCUIT AND WIRING DIAGRAMS**

**Wiring and functions**

**Single comparator type**

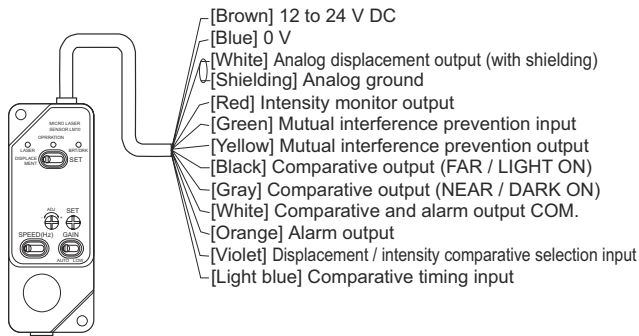

**Window comparator type**

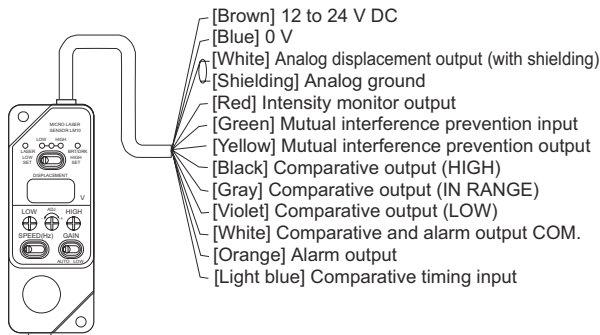

① **Power input [brown (+) · blue (-)]**  
 • Input 12 to 24 V DC.

② **Comparative timing input [light blue]**  
 • While shorted to the 0 V (blue), comparative output is prevented. When using a transistor to establish the timing, use a transistor with a residual output voltage of 1.5 V or less during output.

**Comparative timing input connection example**

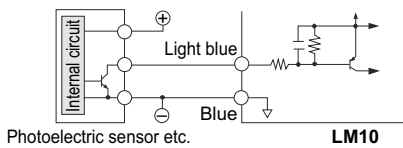

③ **Mutual interference prevention I/O [green (input), yellow (output)]**

• When using two sensors, you can set the mutual interference prevention mode by connecting the input wire of each to the output wire of the other. Be aware that this mode may adversely affect the linearity characteristics, resolution, and response.

④ **Analog displacement output [white, shielding (GND.)]**  
 • An analog voltage / analog current (for each type separately) is output that corresponds to the displacement of the target within the measurement range. When the output selection switch is in the SET position, each comparative setting is outputted as voltage / current (for each type separately).

\* In case of window comparator type  
 In both the voltage output and current output types, the LCD display the voltage ( $\pm 5$  V/F.S.). Between the current output type's analog displacement output and the LCD display, there is a maximum 3 % of F.S. offset. Therefore, exercise caution when aligning the 0 setting the comparative values.

⑤ **Intensity monitor output [red, shielding (GND.)]**

• Analog voltage ( $-5$  V to  $+5$  V) is output corresponding to the amount of light reflected from the target. If the amount of light increases, the voltage value becomes larger and if it decreases, the voltage value becomes smaller.

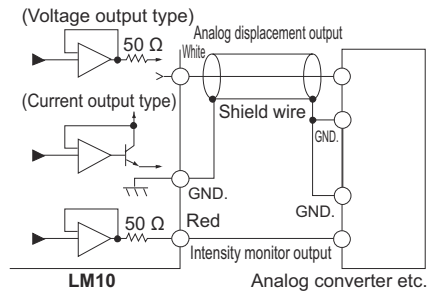

⑥ **Alarm output [orange, white (COM.)]**

• Outputs during insufficient light (DARK) or too much light (BRIGHT).

⑦ **Comparative output**

**Single comparator type [black, gray, white (COM.)]**

| Displacement / intensity comparative selection input [Violet] | Comparing operations  |
|---|---|
| When not connected  | When displacement data is set value or over (far side): FAR / LIGHT ON output is ON.<br>When displacement data is less than set value (near side): NEAR / DARK ON output is ON. |
| When connected to 0 V [blue]                                  | When intensity data is set value or over (near side): FAR / LIGHT ON output is ON.<br>When intensity data is less than set value (far side): NEAR / DARK ON output is ON.       |

Note: With the single comparator type, connecting the violet wire and blue wire changes from the analog displacement output to the light amount monitoring value output.

**Window comparator type [black, gray, violet, white (COM.)]**

Judgment result of analog displacement data is output.

|                 |  |
|-----------------|--|
| LOW [violet]    | Outputs when below the set value's lower limit.              |
| IN RANGE [gray] | Outputs when between the set value's lower and upper limits. |
| HIGH [black]    | Outputs when above the set value's upper limit.              |

**Description of comparative output operations**

**<Double comparator type>**

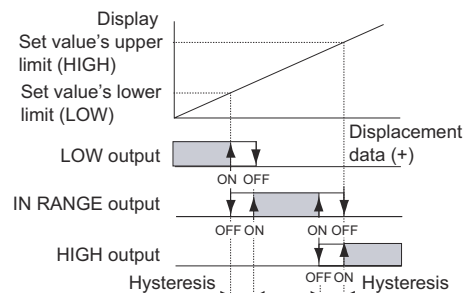

**<Alarm and comparative output connection example>**

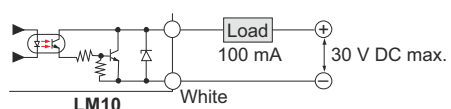

FIBER SENSORS

LASER SENSORS

PHOTO-ELECTRIC SENSORS

MICRO PHOTO-ELECTRIC SENSORS

AREA SENSORS

LIGHT CURTAINS

PRESSURE / FLOW SENSORS

INDUCTIVE PROXIMITY SENSORS

PARTICULAR USE SENSORS

SENSOR OPTIONS

SIMPLE WIRE-SAVING UNITS

WIRE-SAVING SYSTEMS

MEASUREMENT SENSORS

STATIC CONTROL DEVICES

ENDOSCOPE

LASER MARKERS

PLC / TERMINALS

HUMAN MACHINE INTERFACES

ENERGY CONSUMPTION VISUALIZATION COMPONENTS

FA COMPONENTS

MACHINE VISION SYSTEMS

UV CURING SYSTEMS

Selection Guide

Laser Displacement

Magnetic Displacement

Collimated Beam

Digital Panel Controller

Metal-sheet Double-feed Detection

HL-G1

HL-C2

HL-C1

**LM10**

**SENSING CHARACTERISTICS (TYPICAL)**

**Correlation between distance and output range characteristics**

An analog voltage is output that corresponds to the displacement of the target within the measurable range. [( ): current output type]

**ANR1150 ANR11501 ANR1250 ANR12501**

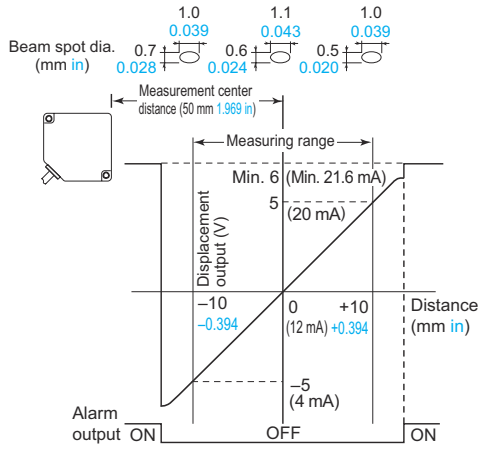

**ANR1151 ANR11511 ANR1251 ANR12511**

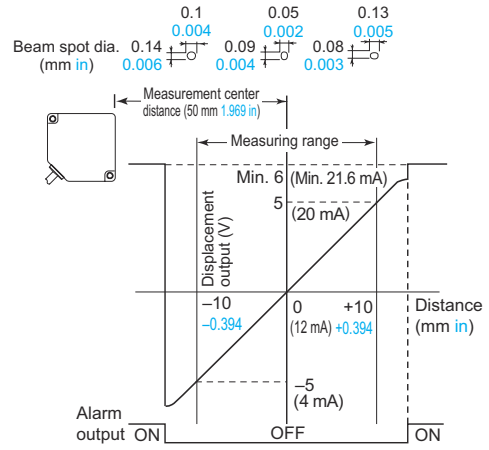

**ANR1182 ANR11821 ANR1282 ANR12821**

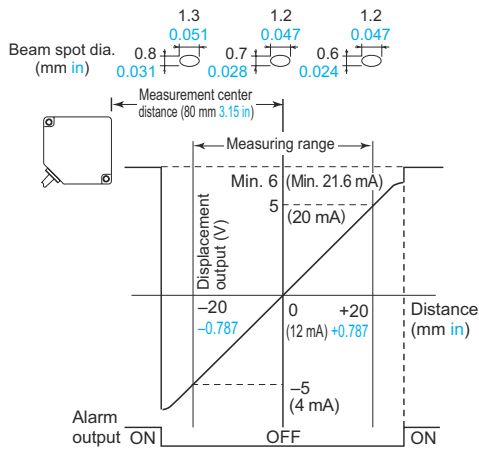

**ANR1115 ANR11151 ANR1215 ANR12151**

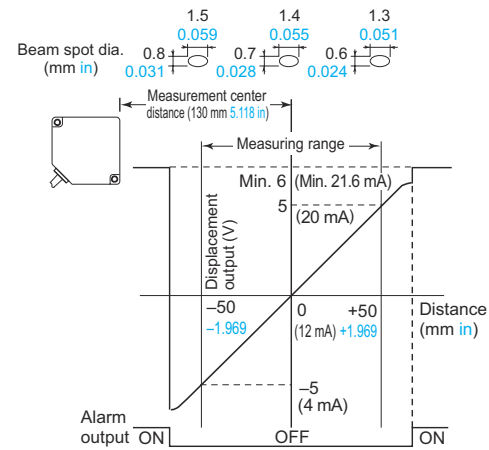

**ANR1226 ANR12261**

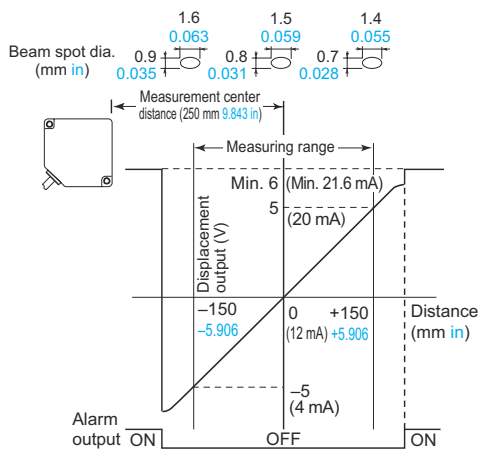

- FIBER SENSORS
- LASER SENSORS
- PHOTO-ELECTRIC SENSORS
- MICRO PHOTO-ELECTRIC SENSORS
- AREA SENSORS
- LIGHT CURTAINS
- PRESSURE / FLOW SENSORS
- INDUCTIVE PROXIMITY SENSORS
- PARTICULAR USE SENSORS
- SENSOR OPTIONS
- SIMPLE WIRE-SAVING UNITS
- WIRE-SAVING SYSTEMS
- MEASURE-NEXT SENSORS
- STATIC CONTROL DEVICES
- ENDOSCOPE
- LASER MARKERS
- PLC / TERMINALS
- HUMAN MACHINE INTERFACES
- ENERGY CONSUMPTION VISUALIZATION COMPONENTS
- FA COMPONENTS
- MACHINE VISION SYSTEMS
- UV CURING SYSTEMS

- Selection Guide
- Laser Displacement
- Magnetic Displacement
- Collimated Beam
- Digital Panel Controller
- Metal-sheet Double-feed Detection
- HL-G1
- HL-C2
- HL-C1
- LM10**

**SENSING CHARACTERISTICS (TYPICAL)**

**Distance characteristics (Class 2 type sensor head)**

**White ceramic (0°, ±20°) vertical orientation**

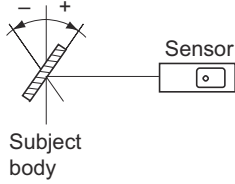

**ANR1250 ANR12501**

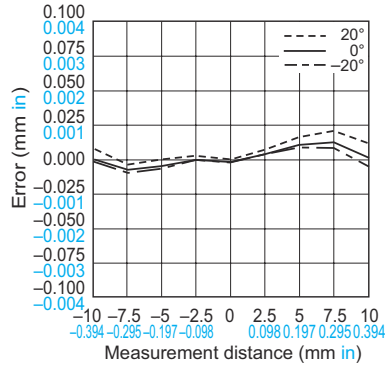

**ANR1251 ANR12511**

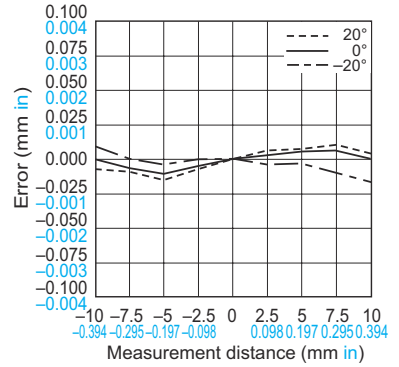

**ANR1282 ANR12821**

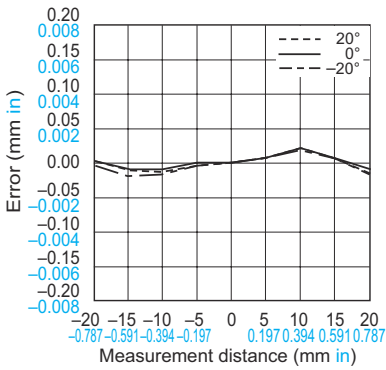

**ANR1215 ANR12151**

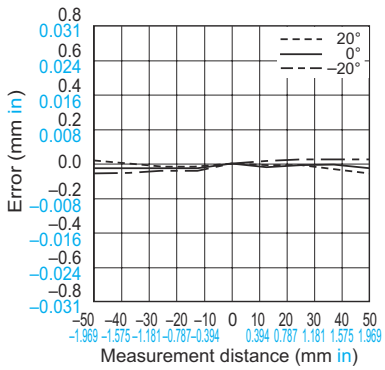

**ANR1226 ANR12261**

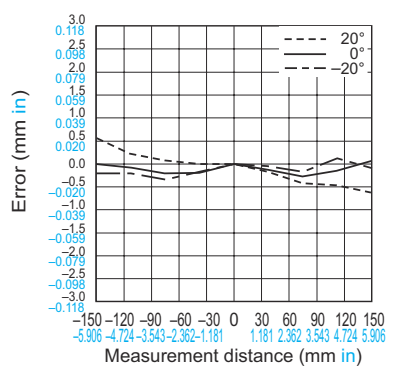

**White ceramic (0°, ±20°) horizontal orientation**

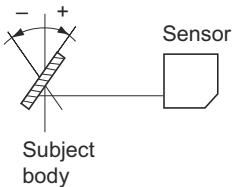

**ANR1250 ANR12501**

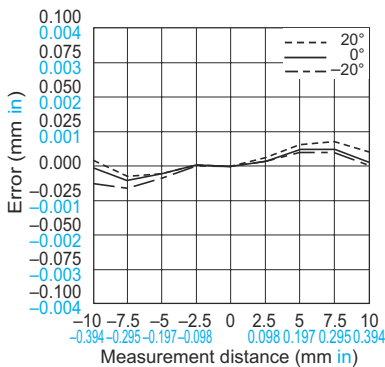

**ANR1251 ANR12511**

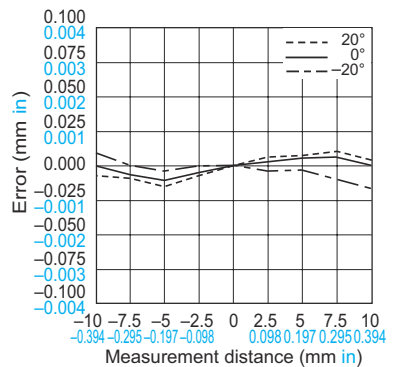

**ANR1282 ANR12821**

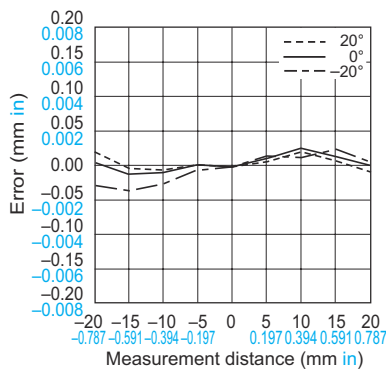

**ANR1215 ANR12151**

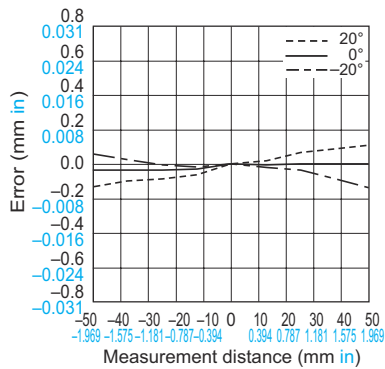

**ANR1226 ANR12261**

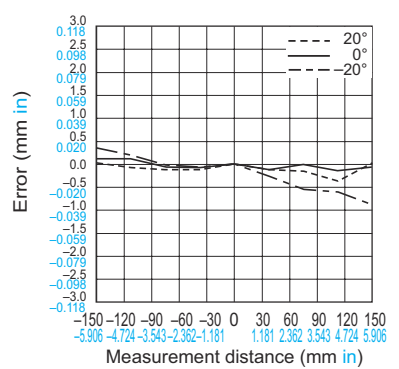

- FIBER SENSORS
- LASER SENSORS
- PHOTO-ELECTRIC SENSORS
- MICRO PHOTO-ELECTRIC SENSORS
- AREA SENSORS
- LIGHT CURTAINS
- PRESSURE / FLOW SENSORS
- INDUCTIVE PROXIMITY SENSORS
- PARTICULAR USE SENSORS
- SENSOR OPTIONS
- SIMPLE WIRE-SAVING UNITS
- WIRE-SAVING SYSTEMS
- MEASUREMENT SENSORS
- STATIC CONTROL DEVICES
- ENDOSCOPE
- LASER MARKERS
- PLC / TERMINALS
- HUMAN MACHINE INTERFACES
- ENERGY CONSUMPTION VISUALIZATION COMPONENTS
- FA COMPONENTS
- MACHINE VISION SYSTEMS
- UV CURING SYSTEMS
- Selection Guide
- Laser Displacement
- Magnetic Displacement
- Collimated Beam
- Digital Panel Controller
- Metal-sheet Double-feed Detection

- HL-G1**
- HL-C2**
- HL-C1**
- LM10**



## PRECAUTIONS FOR PROPER USE

Refer to General precautions and About laser beam.

### PART DESCRIPTION

#### Sensor (ANR11□)

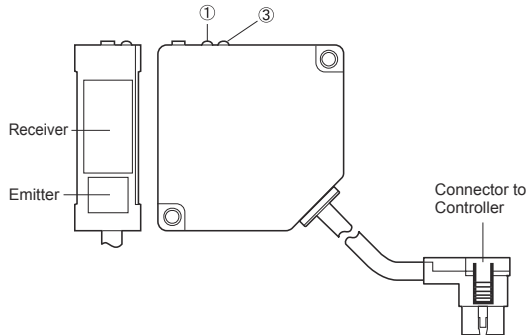

#### Sensor (ANR12□), Extension cable (ANR81□)

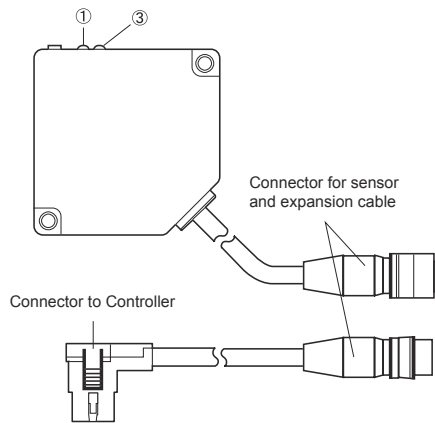

#### Controller (ANR5□)

Single comparator type

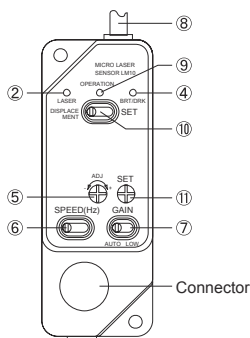

Window comparator type

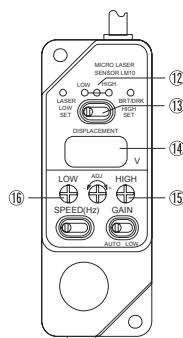

#### For each type

##### ① ② Laser emission indicator LED

The LED lights up during laser emission or just before its emission. To indicate an alarm condition, the LED on the sensor head blinks.

##### ③ Measuring range indicator LED

Blinks when a target is within the measurable range. Lights up when a target is around the measurement center. However, it may light up or blink even with a significant error in the measuring range when the alarm is enabled.

##### ④ Alarm LED

Lights up when measurement is not possible (not enough light [DARK] or too much light [BRIGHT]).

##### ⑤ Zero-point adjusting potentiometer

Adjusts the zero-point position to within a  $\pm 10\%$  of F.S. Use to make minute adjustment after installing the sensor.

##### ⑥ SPEED selection switch

The response speed can be set to one of three settings to allow adjustment for the target speed. When high response speed is unnecessary, set to the 10 Hz mode.

##### ⑦ GAIN selection switch

Under normal conditions, set to AUTO. During edge detection and other applications where you want to cut out the low light level areas, set to LOW.

##### ⑧ I/O cable

#### Only for single comparator type

##### ⑨ Operation indicator LED

Lights up when NEAR / DARK ON output is ON.

##### ⑩ Analog displacement output switch

Switches between the displacement data / intensity data output and the comparative value setting output.

##### ⑪ Comparative value setting potentiometer

Sets the comparative value. By setting the analog displacement output switch to the right, the set value can be monitored by the analog displacement output.

#### Only for window comparator type

##### ⑫ Operation indicator LED

The LED lights up that corresponds to the comparative output currently being output.

##### ⑬ Display / Analog displacement output switch

Switches between the displacement data output and the comparative value setting output.

##### ⑭ LCD display

3-digit display of the displacement data or the upper and lower limit value.

##### ⑮ HIGH limit setting potentiometer

##### ⑯ LOW limit setting potentiometer

Sets the comparative value's upper limit (HIGH) and lower limit (LOW). Set it so that the HIGH value is greater than the LOW value. By setting the display and analog displacement output switch to either LOW or HIGH, you can monitor the set value by display and analog displacement output. When not set, return the switch to the center position.

FIBER SENSORS

LASER SENSORS

PHOTO-ELECTRIC SENSORS

MICRO PHOTO-ELECTRIC SENSORS

AREA SENSORS

LIGHT CURTAINS

PRESSURE / FLOW SENSORS

INDUCTIVE PROXIMITY SENSORS

PARTICULAR USE SENSORS

SENSOR OPTIONS

SIMPLE WIRE-SAVING UNITS

WIRE-SAVING SYSTEMS

MEASURE-NEXT SENSORS

STATIC CONTROL DEVICES

ENDOSCOPE

LASER MARKERS

PLC / TERMINALS

HUMAN MACHINE INTERFACES

ENERGY CONSUMPTION VISUALIZATION COMPONENTS

FA COMPONENTS

MACHINE VISION SYSTEMS

UV CURING SYSTEMS

Selection Guide

Laser Displacement

Magnetic Displacement

Collimated Beam

Digital Panel Controller

Metal-sheet Double-feed Detection

HL-G1

HL-C2

HL-C1

LM10

**PRECAUTIONS FOR PROPER USE**

Refer to General precautions and About laser beam.

- This catalog is a guide to select a suitable product. Be sure to read instruction manual attached to the product prior to its use.



- Never use this product as a sensing device for personnel protection.
- In case of using sensing devices for personnel protection, use products which meet laws and standards, such as OSHA, ANSI or IEC etc., for personnel protection applicable in each region or country.



- This product is classified as a Class 1 / Class 2 Laser Product in IEC / JIS standards and a Class II Laser Product in FDA regulations. Do not look at the laser beam directly or through optical system such as a lens.

- The following label is attached to the product. Handle the product according to the instruction given on the warning label.



(The English warning label based on FDA regulations is pasted on the FDA regulations conforming type.)

(The Japanese warning label is packed with the sensor head.)

**Safety standards for laser beam products**

- A laser beam can harm human being's eyes, skin, etc., because of its high energy density. IEC has classified laser products according to the degree of hazard and the stipulated safety requirements. The **LM10** series is classified as Class 1 / Class 2 laser. (Refer to About laser beam.)

**Safe use of laser products**

- For the purpose of preventing users from suffering injuries by laser products, IEC 60825-1(Safety of laser products). Kindly check the standards before use. (Refer to About laser beam.)

**Procedure for setting the sensor head**

- While watching the measuring range indicator LED, set the sensor head so that the distance to the subject body is within the measuring range. It may light up or blink even with a significant error in the measuring range when the alarm is enabled.

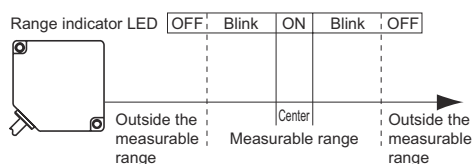

- Be careful of the sensor head's orientation during mounting. When the subject body moves as shown below, errors will develop depending on the orientation of the sensor head. In order to minimize these errors, be sure to mount the sensor head in the correct orientation.

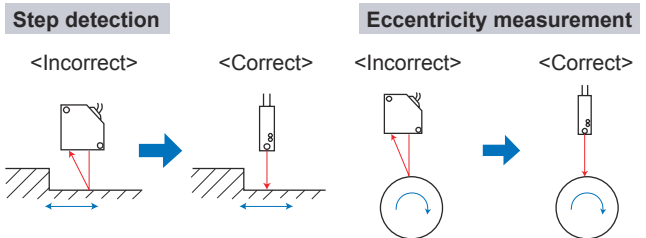
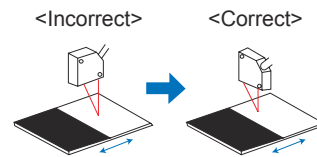
**Extremely different adjacent colors or materials****Mounting the sensor head**

- Using the two mounting holes, firmly mount the sensor head so that the sensor head's front surface is parallel to the target. Do not tighten the installation screws to a torque over 2 N·m.
- Glass is used at the sensor head's light emitting and light receiving surfaces and, therefore, **never subject it to impacts of any kind**. Also, be very careful not to allow oils, finger prints, or other substances that may refract the light, to get on the glass during mounting.
- If light reflected off the target is then reflected off nearby objects or walls and then received by the sensor head, the sensor head reading will be adversely affected. To prevent this, either further separate the sensor head or apply a black delustering paint to prevent the unwanted reflection of light.

**Mounting the controller**

- When mounting more than one controller in a row, **maintain at least 10 mm 0.394 in between each unit**. Also, when mounting the controller inside control panels or other areas where the air is not properly ventilated, the controller will cause the ambient temperature to rise. In these cases, **ensure the proper cooling facilities**.

**Wiring**

- Perform all wiring by faithfully following the input and output circuit explanations and documents that came with the instrument. Also, **to protect the inner circuitry, arrange the lead wire that is not interconnected in a way so that it does not come into contact with other lead wires**.
- When mounting or removing a connector, always **first turn off the controller** and then begin operations.
- All connectors are of the lock-on type. When connecting a connector, be sure to securely insert it until it locks into place. When removing a connector, **first press in the lock release button on the connector side** and then remove the connector.
- After removing a connector, **do not touch the terminals located inside**.

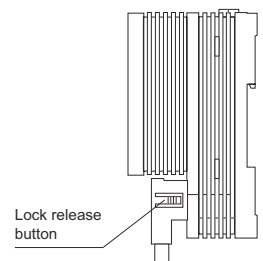

FIBER SENSORS

LASER SENSORS

PHOTO-ELECTRIC SENSORS

MICRO PHOTO-ELECTRIC SENSORS

AREA SENSORS

LIGHT CURTAINS

PRESSURE / FLOW SENSORS

INDUCTIVE PROXIMITY SENSORS

PARTICULAR USE SENSORS

SENSOR OPTIONS

SIMPLE WIRE-SAVING UNITS

WIRE-SAVING SYSTEMS

MEASURE-MENT SENSORS

STATIC CONTROL DEVICES

ENDOSCOPE

LASER MARKERS

PLC / TERMINALS

HUMAN MACHINE INTERFACES

ENERGY CONSUMPTION VISUALIZATION COMPONENTS

FA COMPONENTS

MACHINE VISION SYSTEMS

UV CURING SYSTEMS

Selection Guide

Laser Displacement

Magnetic Displacement

Collimated Beam

Digital Panel Controller

Metal-sheet Double-feed Detection

HL-G1

HL-C2

HL-C1

LM10

## PRECAUTIONS FOR PROPER USE

Refer to General precautions and About laser beam.

### Cable

- When the sensor head and controller are fixed and cables connected, **do not subject the cables to a pull of more than 3 kg. Have no bends in the cables with a radius of less than 20 mm 0.787 in. Also, do not bend a sensor head's cable near where the cable is attached to the sensor head.**
- When the sensor head is to be moved while in use, do not have it so that the sensor head's cable becomes bent. If the location is such that it cannot be helped, we recommend purchasing the appropriate length extension cable (ANR12□).

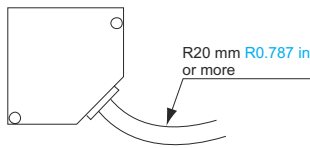

### Area of interference

- When using more than one sensor together, be careful of the area of interference.

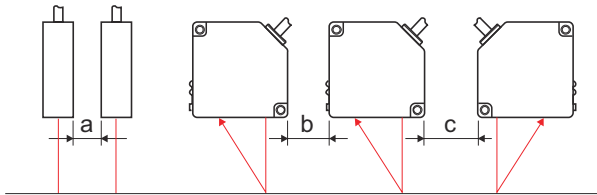

Units: mm in

| Sensor head model No. | a         | b          | c          |
|-----------------------|-----------|------------|------------|
| ANR1150, ANR11501     | 40 1.575  | 20 0.787   | 70 2.756   |
| ANR1151, ANR11511     |           |            |            |
| ANR1182, ANR11821     | 50 1.969  | 60 2.362   | 110 4.331  |
| ANR1115, ANR11151     | 80 3.150  | 100 3.937  | 150 5.906  |
| ANR1250, ANR12501     |           |            |            |
| ANR1251, ANR12511     | 50 1.969  | 40 1.575   | 90 3.543   |
| ANR1282, ANR12821     | 80 3.150  | 80 3.150   | 130 5.118  |
| ANR1215, ANR12151     | 120 4.724 | 140 5.512  | 190 7.748  |
| ANR1226, ANR12261     | 210 8.268 | 350 13.780 | 400 15.748 |

### Operating environment

- Use in an ambient temperature between **0 to +50 °C +32 to +122 °F**. Store in a location where the temperature stays between -20 to +70 °C -4 to +158 °F.
- Use in an ambient humidity between 35 to 85 % RH. Avoid use in locations with drastic humidity changes which cause condensation.
- Use in locations where the illuminance from incandescent lamps received at the light receiving surface is below 2,500 lx (ANR11□ and ANR1226), or below 3,000 lx (ANR1250, ANR1251, ANR1282, ANR1215). Also, locate the unit so that sunlight, **does not directly hit the beam-receiving part**. When exceptional accuracy is required, **mount a shielding plate or other type of shading mechanism**.
- The power supply voltage should be between 85 to 110 % of the rated voltage.
- Since the internal circuits may become damaged if an external surge voltage exceeds 500 V [ $\pm(1.2 \times 50)$  μs unipolar full-wave voltage], always use a surge absorber or surge absorbing element.

- Keep the sensor head beam-emitting part and beam-receiving part surface clean and free of moisture, oil, finger prints, and other light refracting substances, and free of dust, dirt, and other light blocking substances.**

When cleaning the glass surfaces, wipe with a soft cloth or lens cleaning paper.

- Although the sensor head is of water proof construction, it does not mean that measurements can be taken underwater or in the rain. Moreover, **the connectors are not watertight**.
- Do not use the unit in locations with flammable or corrosive gases, locations with excessive dust, locations splashed by water, or locations subjected to vibrations or excessive shocks.
- Since the controller contains molded resins, do not use in environments that contain, or where contact with, benzene, thinners, alcohols and other organic solvents; and ammonia, caustic sodas, and other alkaline substances is possible.

### Noise precautions

- The connector's metal portion is internally connected to the analog output GND. In order to prevent affects from noise or damage to the internal circuits, be sure to insulate the metal portion with electrical tape or other means.
- Mount the unit as far away as possible from high voltage lines, power lines, or devices that generate large switching surges.**
- Separate the sensor head cable wiring, high voltage circuit, and power circuit.
- If there is much noise on the power supply, it will affect the analog output. In such cases, use a noise filter or noise-cut transformer.

### Insulation resistance and voltage withstandability

- Do not perform insulation resistance or withstand voltage tests between the connector's metal portions and input / outputs.

### Power supply

- Select a power supply with a **ripple voltage below 0.5 V (P-P) and a current capacity above 0.3 A**.
- In order to avoid high-frequency noises when using a commercially available switching regulator, be sure to ground the frame ground (F.G.) terminal.
- When using a power supply that uses a transformer, be sure to use an insulated transformer. When using an autotransformer (single-wound transformer), it is possible to damage this unit or the power supply.
- Do not turn the power on again within 10 sec. after turning the power off.

### Warm-up time

- Allow at least 30 minutes, after turning on the unit, for the unit to properly warm up.**

FIBER SENSORS

LASER SENSORS

PHOTO-ELECTRIC SENSORS

MICRO PHOTO-ELECTRIC SENSORS

AREA SENSORS

LIGHT CURTAINS

PRESSURE / FLOW SENSORS

INDUCTIVE PROXIMITY SENSORS

PARTICULAR USE SENSORS

SENSOR OPTIONS

SIMPLE WIRE-SAVING UNITS

WIRE-SAVING SYSTEMS

MEASURE-HEAT SENSORS

STATIC CONTROL DEVICES

ENDOSCOPE

LASER MARKERS

PLC / TERMINALS

HUMAN MACHINE INTERFACES

ENERGY CONSUMPTION VISUALIZATION COMPONENTS

FA COMPONENTS

MACHINE VISION SYSTEMS

UV CURING SYSTEMS

Selection Guide

Laser Displacement

Magnetic Displacement

Collimated Beam

Digital Panel Controller

Metal-sheet Double-feed Detection

HL-G1

HL-C2

HL-C1

LM10

**DIMENSIONS (Unit: mm in)**

The CAD data in the dimensions can be downloaded from our website.

**ANR11□ Sensor head**

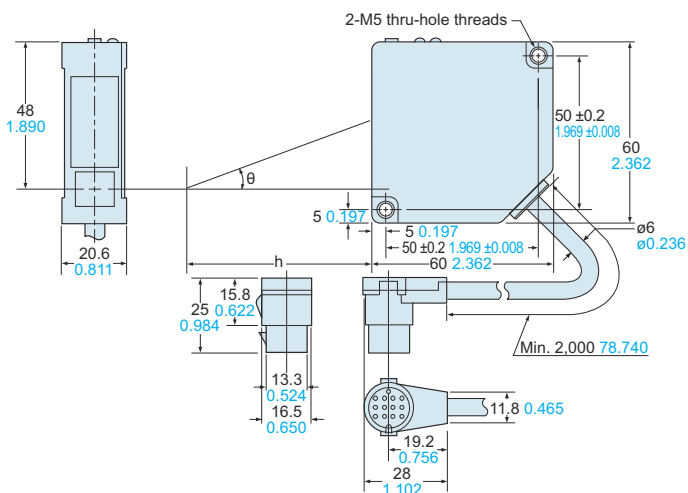

| Model No.         | Mark | h               | θ   |
|-------------------|------|-----------------|-----|
| ANR115□, ANR115□1 |      | 50 mm 1.969 in  | 20° |
| ANR1182, ANR11821 |      | 80 mm 3.150 in  | 16° |
| ANR1115, ANR11151 |      | 130 mm 5.118 in | 11° |

**ANR12□ Sensor head**

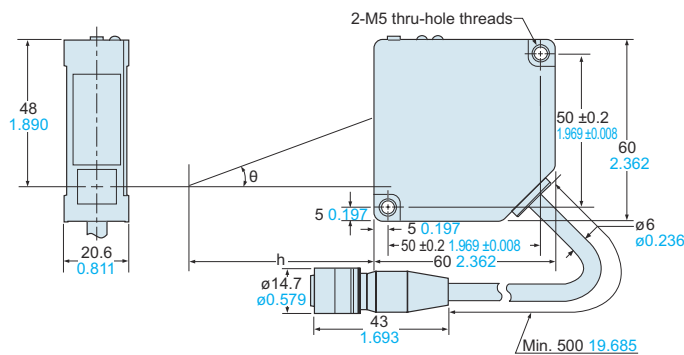

| Model No.         | Mark | h               | θ    |
|-------------------|------|-----------------|------|
| ANR125□, ANR125□1 |      | 50 mm 1.969 in  | 20°  |
| ANR1282, ANR12821 |      | 80 mm 3.150 in  | 16°  |
| ANR1215, ANR12151 |      | 130 mm 5.118 in | 11°  |
| ANR1226, ANR12261 |      | 250 mm 9.843 in | 5.8° |

**ANR81□ Intermediate cable for ANR12□ (Accessory for sensor head)**

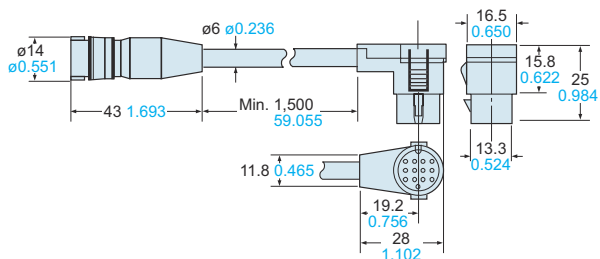

**ANR5□ Controller**

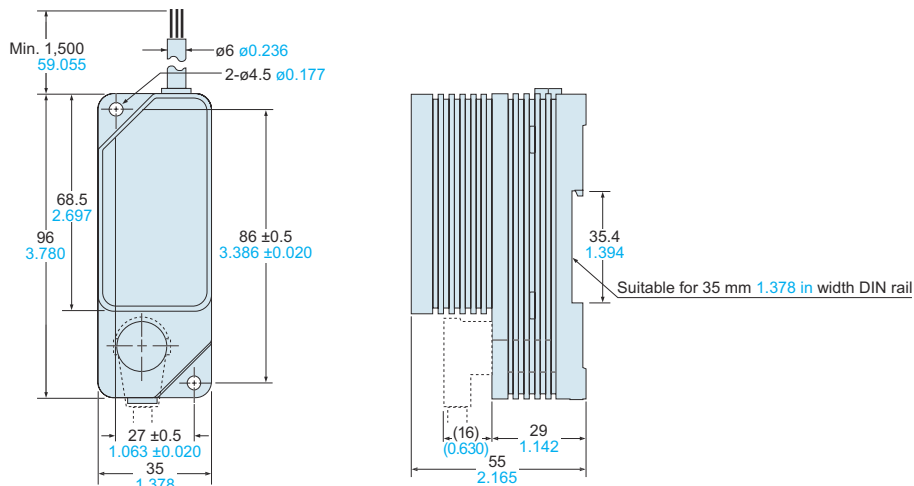

FIBER SENSORS

LASER SENSORS

PHOTO-ELECTRIC SENSORS

MICRO PHOTO-ELECTRIC SENSORS

AREA SENSORS

LIGHT CURTAINS

PRESSURE / FLOW SENSORS

INDUCTIVE PROXIMITY SENSORS

PARTICULAR USE SENSORS

SENSOR OPTIONS

SIMPLE WIRE-SAVING UNITS

WIRE-SAVING SYSTEMS

MEASURE-MENT SENSORS

STATIC CONTROL DEVICES

ENDOSCOPE

LASER MARKERS

PLC / TERMINALS

HUMAN MACHINE INTERFACES

ENERGY CONSUMPTION VISUALIZATION COMPONENTS

FA COMPONENTS

MACHINE VISION SYSTEMS

UV CURING SYSTEMS

Selection Guide

Laser Displacement

Magnetic Displacement

Collimated Beam

Digital Panel Controller

Metal-sheet Double-feed Detection

**HL-G1**

**HL-C2**

**HL-C1**

**LM10**