



iCE40 16-WLCSP Evaluation Kit

User's Guide

Introduction

Thank you for choosing the Lattice iCE40™ 16-WLCSP Evaluation Kit.

This guide describes how to begin using the iCE40 16-WLCSP Evaluation Kit, an easy-to-use platform for rapidly prototyping system control designs using an iCE40 FPGA. Along with the evaluation board and accessories, this kit includes the pre-loaded LED Driver Demo that demonstrates driving the IR, Bar Code and RGB LEDs with a PWM circuit.

The contents of this user's guide include demo operation, top-level functional descriptions of the various portions of the evaluation board, descriptions of the on-board connectors, switches, a complete set of schematics and the bill of materials for the iCE40 16-WLCSP Evaluation Board.

Note: Static electricity can severely shorten the lifespan of electronic components. Be careful when handling the iCE40 16-WLCSP Evaluation Kit as to not damage it from ESD.

Features

The iCE40 16-WLCSP Evaluation Kit includes:

- **iCE40 16-WLCSP Evaluation Board** – The ICE40 16-WLCSP Evaluation Board features the following on-board components and circuits:
 - iCE40 (iCE40LP1K-SWG16) device in a 16-ball WLCSP package.
 - Example of a board using this 0.35-pitch WLCSP package.
 - High-current LED output
 - Infrared transmit
 - Barcode emulation
 - 27MHz oscillator
 - iCE40 Current Measurements
 - Standard USB cable for device programming
 - RoHS-compliant packaging and process
- **Pre-loaded Demo** – The kit includes a pre-loaded demo to control the onboard RGB LED in conjunction with a software run GUI.
- **USB Connector Cable** – A mini B USB port provides power, a programming interface and communication for the software RGB LED GUI to the ICE40 SPI port.

Figure 1 shows the top side of the iCE40 16-WLCSP Evaluation Board indicating the specific features that are designed on the board.

Figure 1. iCE40 16-WLCSP Evaluation Board (Top Side)

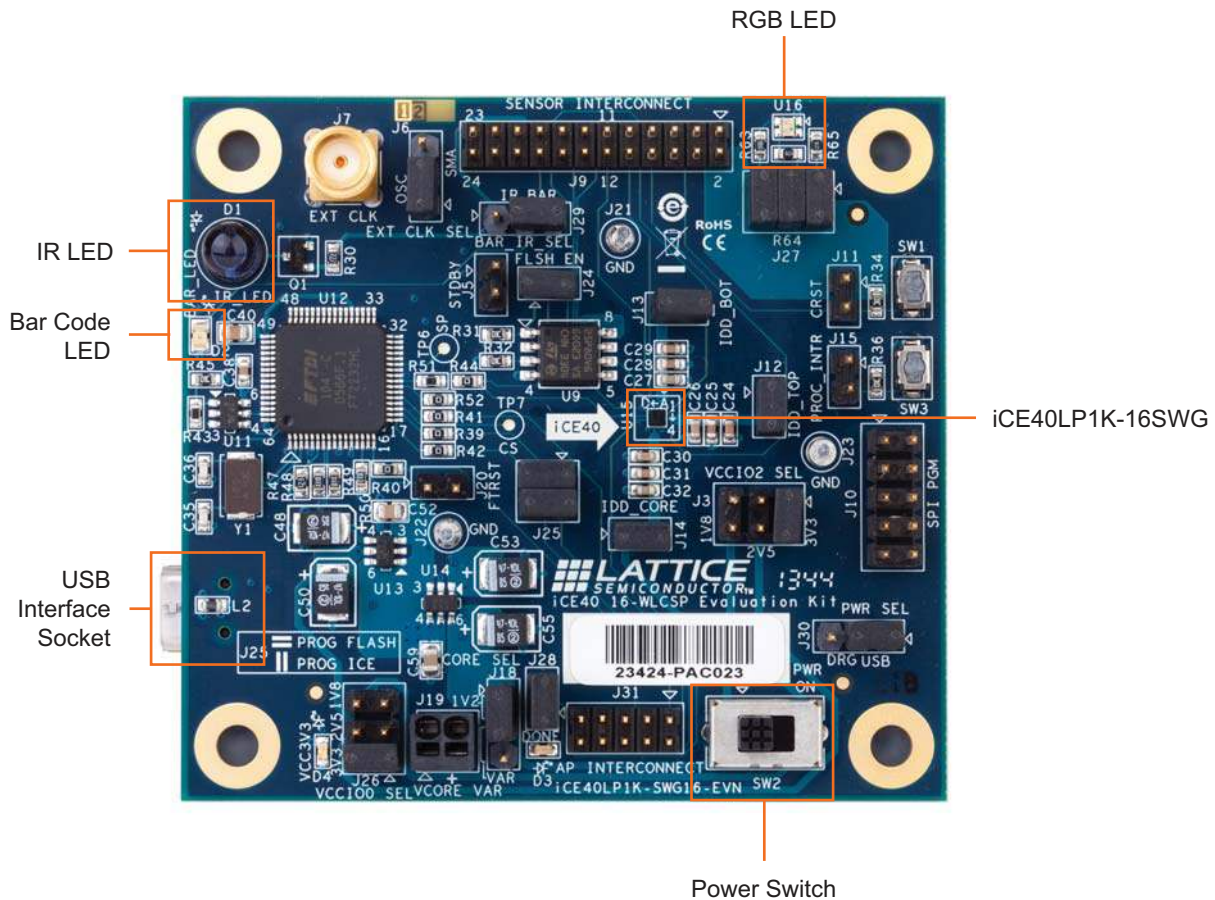

iCE40 Device

The board features an ICE40LP1K FPGA with a 1.2V core supply. The device is packaged in a 16-ball WLCSP. For a complete description of this device, see HB1011, [iCE40 LP/LX/LM Family Handbook](#).

Software Requirements

You should install the following software before you begin developing designs for the board:

- Lattice iCEcube2 2013.08 (or higher)
- Diamond Programmer 2.2 (or higher)

These software are available at the Lattice website [Design Software & IP](#) page. Make sure you log in to www.lattice-ese.com, otherwise these software downloads will not be visible. It is also recommended to download the RGG LED software GUI which interfaces with the iCE40 16-WLCSP Evaluation Kit. This GUI allows you to control the RGB LED for color, brightness, blinking and breathing. Download the PC or MAC version of the GUI at www.lattice-ese.com.

Demonstration Design Shunts

Lattice provides the RGB LED Driver Demo design programmed in the board. The RGB LED Driver Demo used in conjunction with the software GUI illustrates the use of a PWM driver controlling the LEDs on the board. Below is a description of the control jumpers for each LED.

- The RGB LED will transition colors
 - J27 can be used to probe RGB LED (Default shunted). If you remove J27, the RGB LED will not light up.
- The IR LED will toggle when a shunt is placed across J29 pins 1-2
- The Bar Code LED will toggle when a shunt is placed across J29 pins 2-3 (Default shunted)

Figure 2 shows the default board shunt locations.

Figure 2. Default Shunt Locations

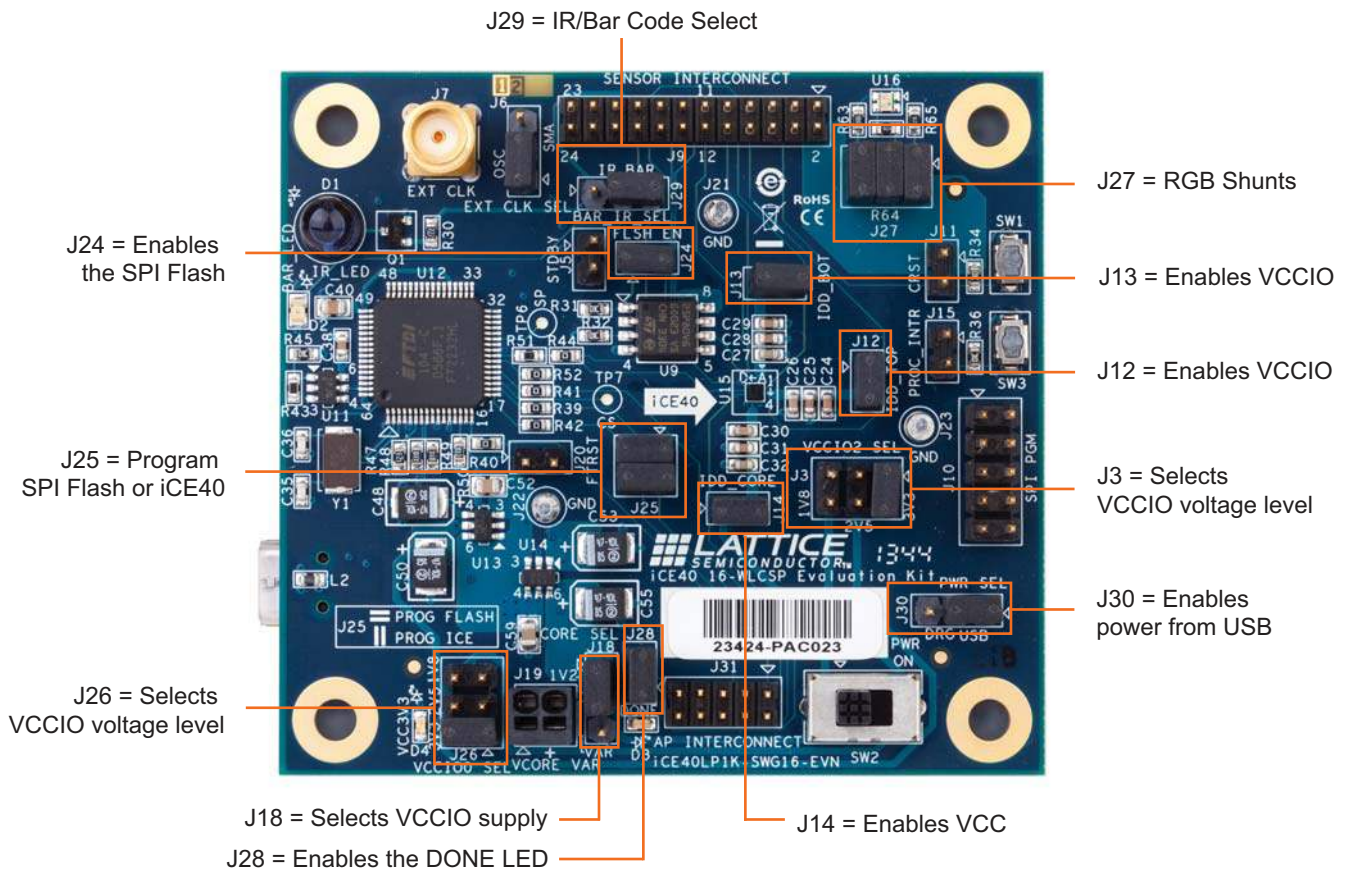

Clock Sources

The board has two options for clock sources. The clock drives the iCE40LP1k device directly

- 27 MHz Oscillator shunt J6 pins 1-2 (Default shunted)
- SMA External clock shunt J6 pins 2-3

Figure 3 shows the J6 pins.

Figure 3. J6 Pins Location

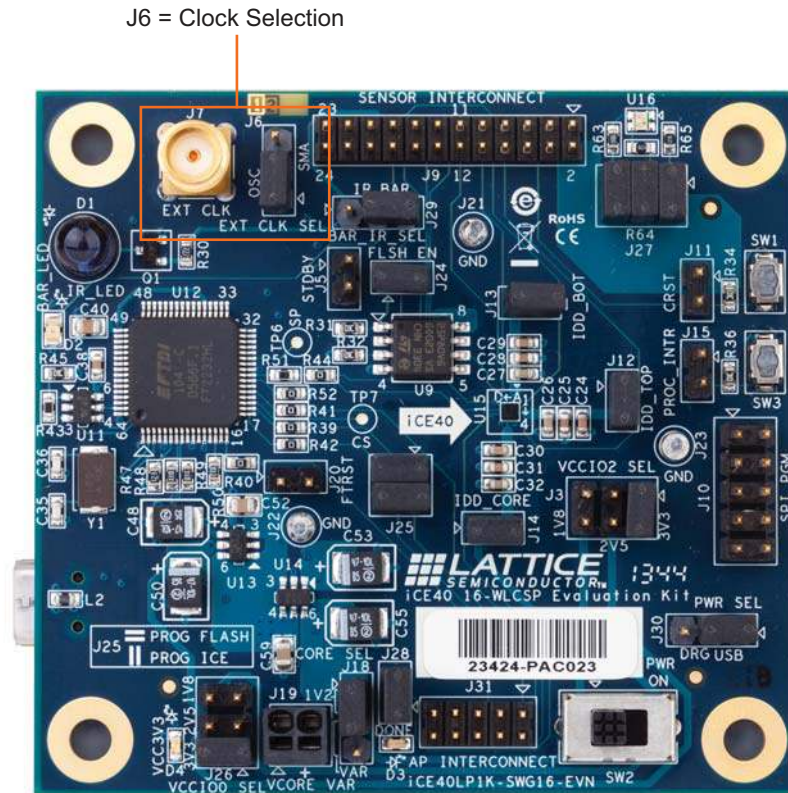

Board Power

The board provides a number of power options:

- Board Power
 - SW2 is the boards On/Off switch
 - D3 Blue LED indicates power
 - Power the board with USB power shunt J30 pins 1-2 (Default shunted)
 - Power the board with a Dragon Board shunt J30 pins 2-3
- iCE40 ICC
 - Supply Options
 - Onboard 1.2V supply shunt J18 pins 1-2 (Default shunted)
 - External 1.2V supply shunt J18 pins 2-3
 - Current Measurement
 - ICC can be measured with an ammeter on J14 (Default shunted)
- iCE40 ICCIO
 - Supply Options
 - VCCIO3_2_1_SPI 3.3V supply shunt J3 pins 1-2 (Default shunted)
 - VCCIO3_2_1_SPI 2.5V supply shunt J3 pins 3-4
 - VCCIO3_2_1_SPI 1.8V supply shunt J3 pins 5-6
 - VCCIO0 3.3V supply shunt J26 pins 1-2 (Default shunted)
 - VCCIO0 2.5V supply shunt J26 pins 3-4
 - VCCIO0 1.8V supply shunt J26 pins 5-6
 - Current Measurement
 - ICC_3_2_1_SPI can be measured with an ammeter on J13 (Default shunted)
 - ICC_0 can be measured with an ammeter on J12 (Default shunted)

Board Configuration and Programming

The board allows for programming of the iCE40 or the SPI Flash:

- USB to iCE40 SPI port J16
- SPI Flash Programming J25 shunt pins 1-3 and 2-4 (Default shunted)
 - U9 Micron Technology Inc part number M25P80-VMW6TG
- iCE40 Configuration or Programming J25 shunt pins 1-2 and 3-4
 - U15 iCE40LP1K-SWG16
- CRESETB can be asserted by pushing SW1
 - Can be probed with J11
- Done LED D3
 - Can be probed with J28 (Default shunted)

Details of the iCE40 Board for use in programming are shown in Figure 4.

Figure 4. Configuration and Programming Details

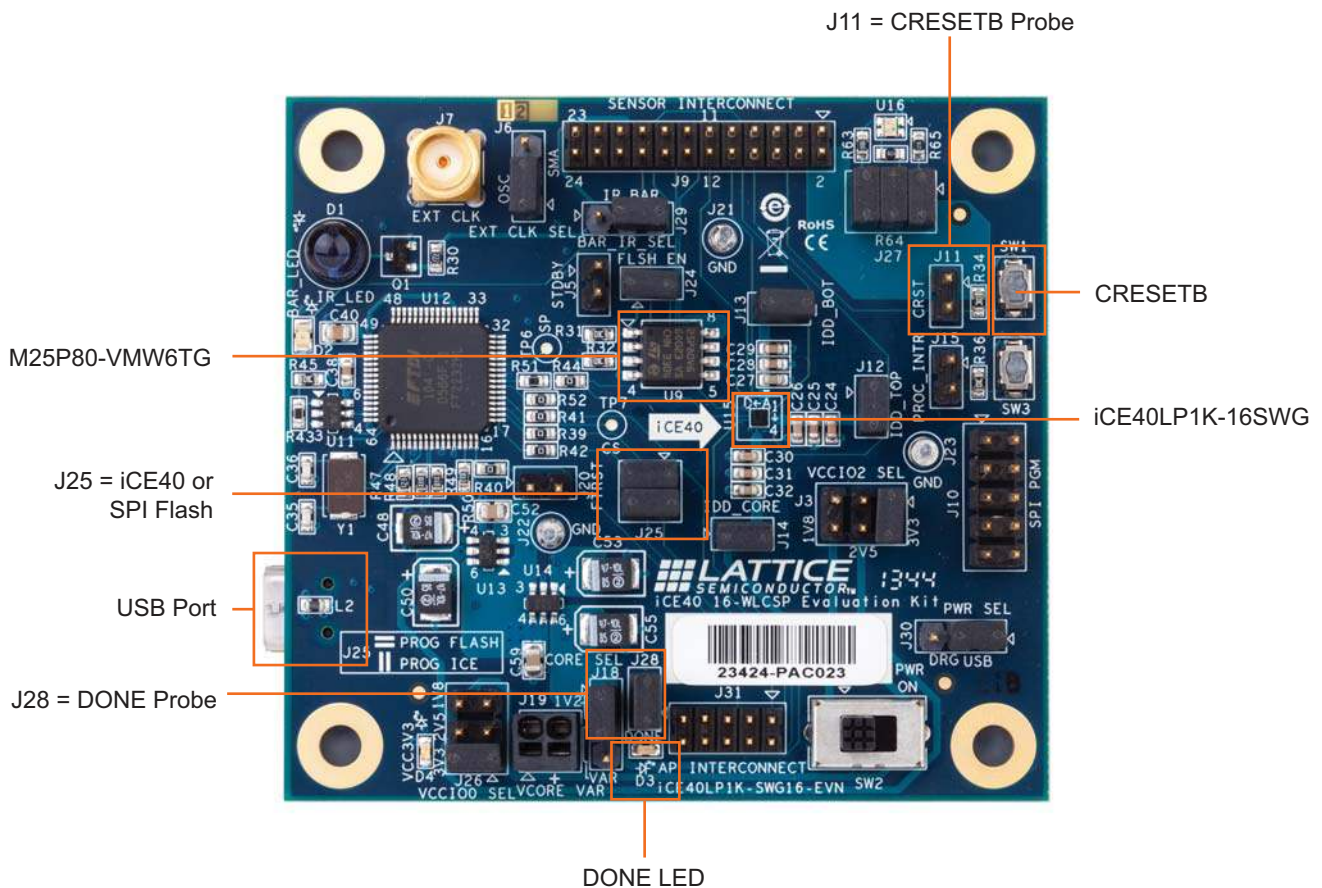

Test Points

The board features a number of test points which provide access to the iCE40 I/Os:

- J9 provides the following test points as shown in Figure 6:

Figure 5. J9 AP and Sensor Interconnects

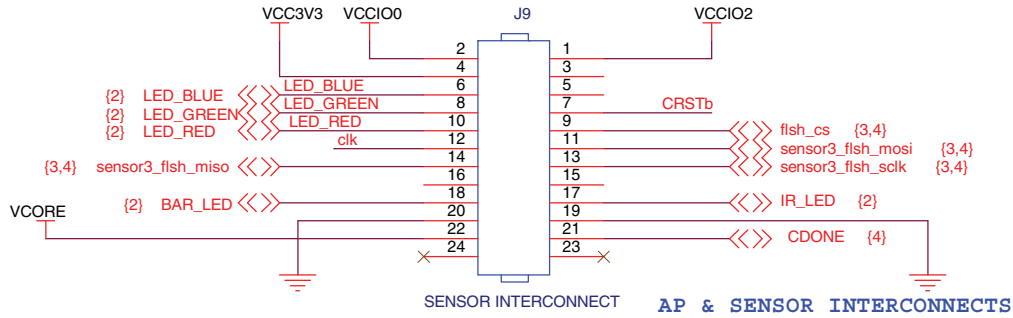

- J31 provides the following test points as shown in Figure 6

Figure 6. J31 AP Interconnect

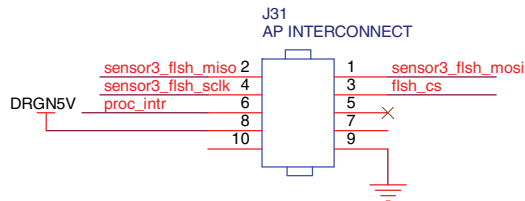

The J9 and J10 test points are shown in Figure 7

Figure 7. J9 and J10 Test Points

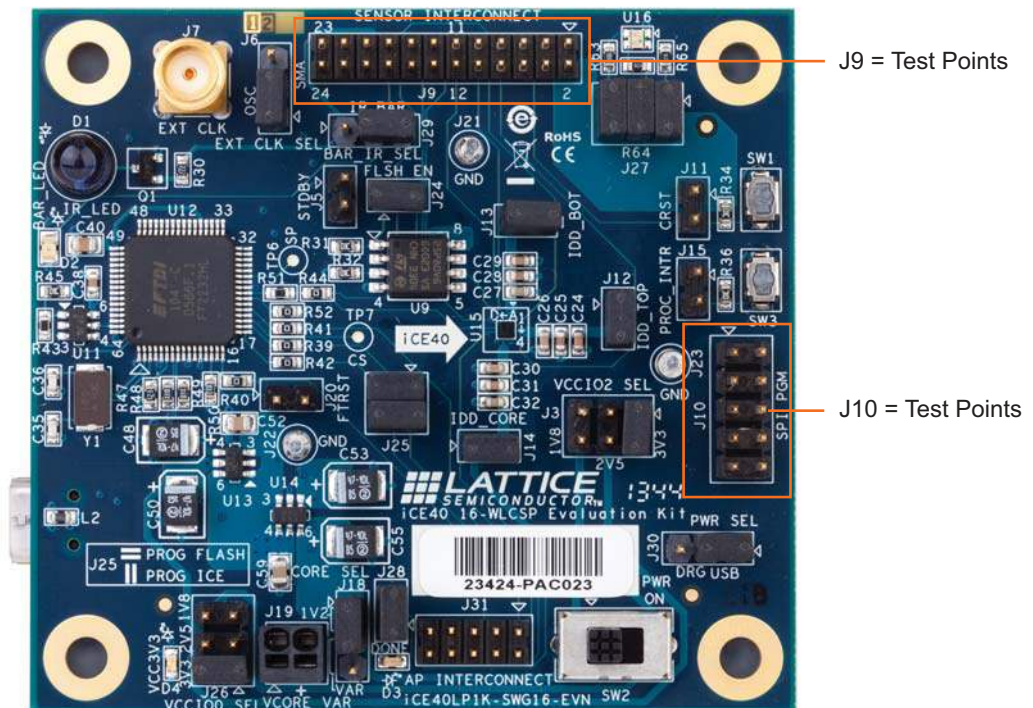

RGB LED Demonstration Design and Software GUI

The iCE40 16-WLCSP Evaluation Kit can demonstrate a complete controller for an RGB LED. These are the steps necessary to run the demonstration.

1. Ensure that the RGB LED GUI is installed.
2. Make sure the jumpers on J25 are both in the horizontal position. This is the default pins 1-3 and 2-4 shorted together.

Figure 8. SPI Flash Selection Horizontal Position for J25

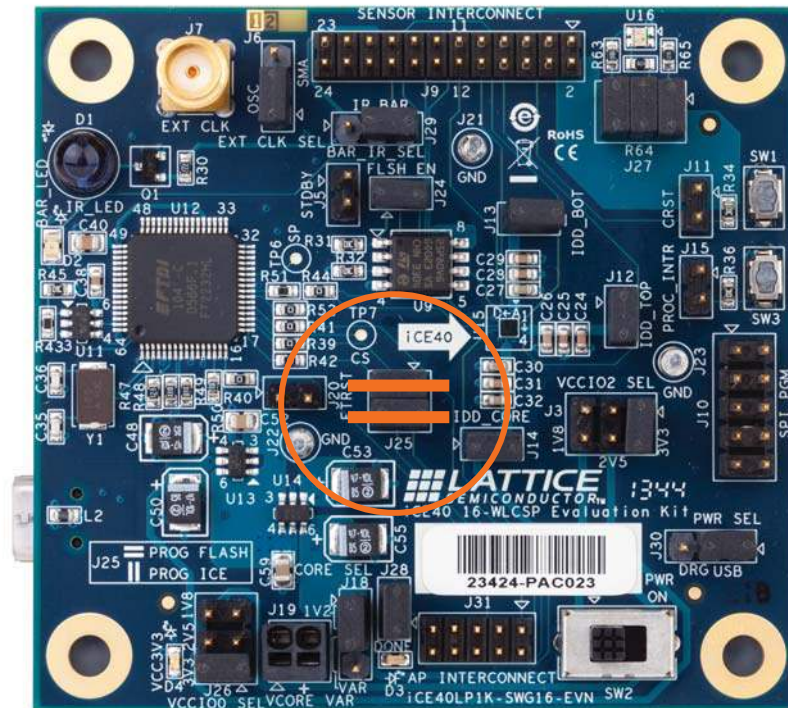

3. Connect the iCE40 16-WLCSP evaluation board via the USB cable to a PC or MAC.

- After the iCE40 device has initialized and the red barcode LED is flashing, change the J25 jumper positions to vertical. Short pins 1-2 and 3-4. This is required to allow the USB port to communicate with the iCE40 device.

Figure 9. SPI Flash Selection Vertical Position for J25

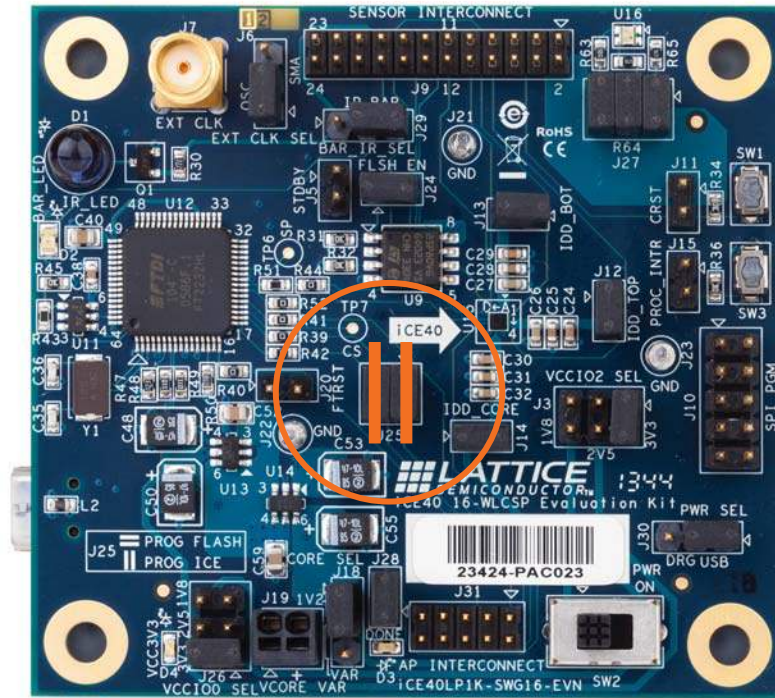

- Start the RBG GUI on the PC or MAC.

Figure 10. iCE40LP LED Demonstration Interface

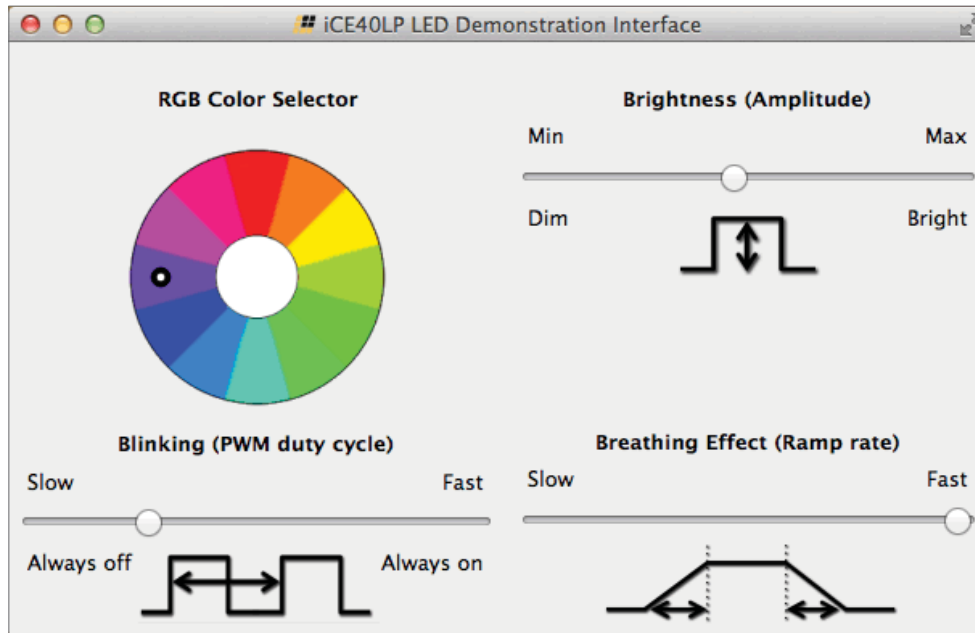

Now you can control the RGB LED on the iCE40 16-WLCSP Evaluation board. You can set the color, brightness, blinking rate as well as breathing.

GUI Serial Communication Interface

LED Control via SPI

The Software GUI demonstration program communicates with the iCE40 device using a SPI serial communication channel. The SPI interface (mode 0) control link is implemented using a simple write-only protocol (see Figure 11).

Figure 11. SPI Physical Transaction

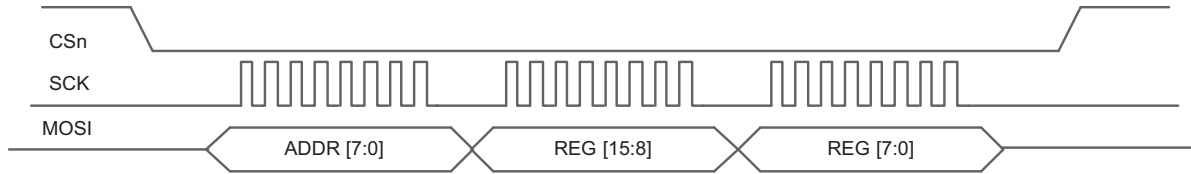

SPI Protocol

Data on the MOSI serial line is transmitted MSB first.

Addr[7:0] – Controls which of the 16 bits are updated with REG data.

Note: Unspecified REG bits must be written, but are ignored.

Addr	Bits Written	Bit Position
0x13	REG[3:0]	-----dddd
0x14	REG[7:4]	-----cccc----
0x15	REG[11:8]	----bbbb-----
0x16	REG[15:12]	aaaa-----
0x19	REG[15:0]	aaaabbbbccccdddd

REG[15:0] – Consists of four control fields.

Field	Bit Positions	Function
aaaa	REG[15:12]	RGB Color[3:0]
bbbb	REG[11:8]	Brightness[3:0]
cccc	REG[7:4]	Breathe Ramp [3:0]
dddd	REG[3:0]	Blink Rate [3:0]

Register Definitions

Default setting (hardware, software) is denoted by (*).

RGB Color[3:0]	Color	Color Code
0000*	Red	#FF0000
0001	Orange	#FF7F00
0010	Yellow	#FFFF00
0011	Chartreuse	#7FFF00
0100	Green	#00FF00
0101	Spring Green	#00FF7F
0110	Cyan	#00FFFF
0111	Azure	#007FFF
1000	Blue	#0000FF
1001	Violet	#7F00FF
1010	Magenta	#FF00FF
1011	Rose	#FF007F
1100	-	
1101	-	
1110	-	
1111	White	#FFFFFF

Brightness[3:0]	Level (%)
0000	6.25(dim)
0001	12.5
0010	18.75
0011	25
0100	31.25
0101	37.5
0110	43.75
0111*	50
1000	56.25
1001	62.5
1010	68.75
1011	75
1100	81.25
1101	87.5
1110	93.75
1111	100 (bright)

Breathe Ramp [3:0]	Factor
0000*	.0x (fast)
0001	.063x
0010	.125x
0011	.25x
0100	.5x
0101	1x
0110	2x
0111	4x (slow)
1000	-
1001	-
1010	-
1011	-
1100	-
1101	-
1110	-
1111	-

Blink Rate [3:0]	Off Time (s) ¹
0000	Always On
0001	1/16 (fast)
0010	1/8
0011	1/4
0100	1/2
0101*	1
0110	2
0111	4
1000	Always Off
1001	-
1010	-
1011	-
1100	-
1101	-
1110	-
1111	-

1. By default the LED "On-Time" is fixed at approximately one second. If desired, the design may be modified so that "On-Time" is symmetrical to the "Off-Time". To do so, replace the file "LED_control.v" with "LED_control_sym.v" and rebuild the design using the iCEcube2 software.

Ordering Information

Description	Ordering Part Number	China RoHS Environment-Friendly Use Period (EFUP)
iCE40 16-WLCSP Evaluation Kit	iCE40LP1K-SWG16-EVN	

Technical Support Assistance

e-mail: techsupport@latticesemi.com

Internet: www.latticesemi.com

Revision History

Date	Version	Change Summary
February 2014	01.0	Initial release.

© 2014 Lattice Semiconductor Corp. All Lattice trademarks, registered trademarks, patents, and disclaimers are as listed at www.latticesemi.com/legal. All other brand or product names are trademarks or registered trademarks of their respective holders. The specifications and information herein are subject to change without notice.

Appendix A. Schematic Diagrams

Figure 12. Block Diagram

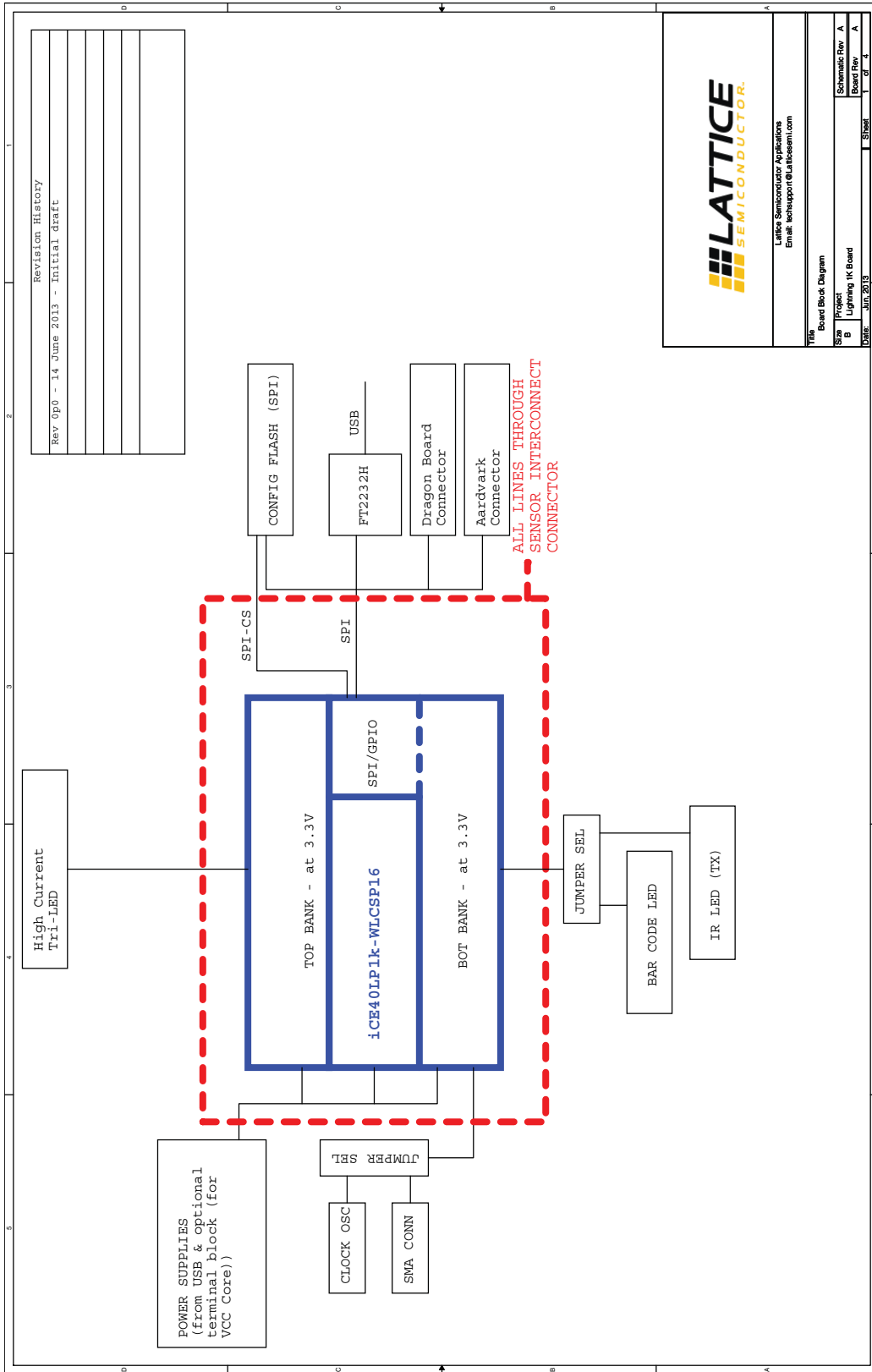
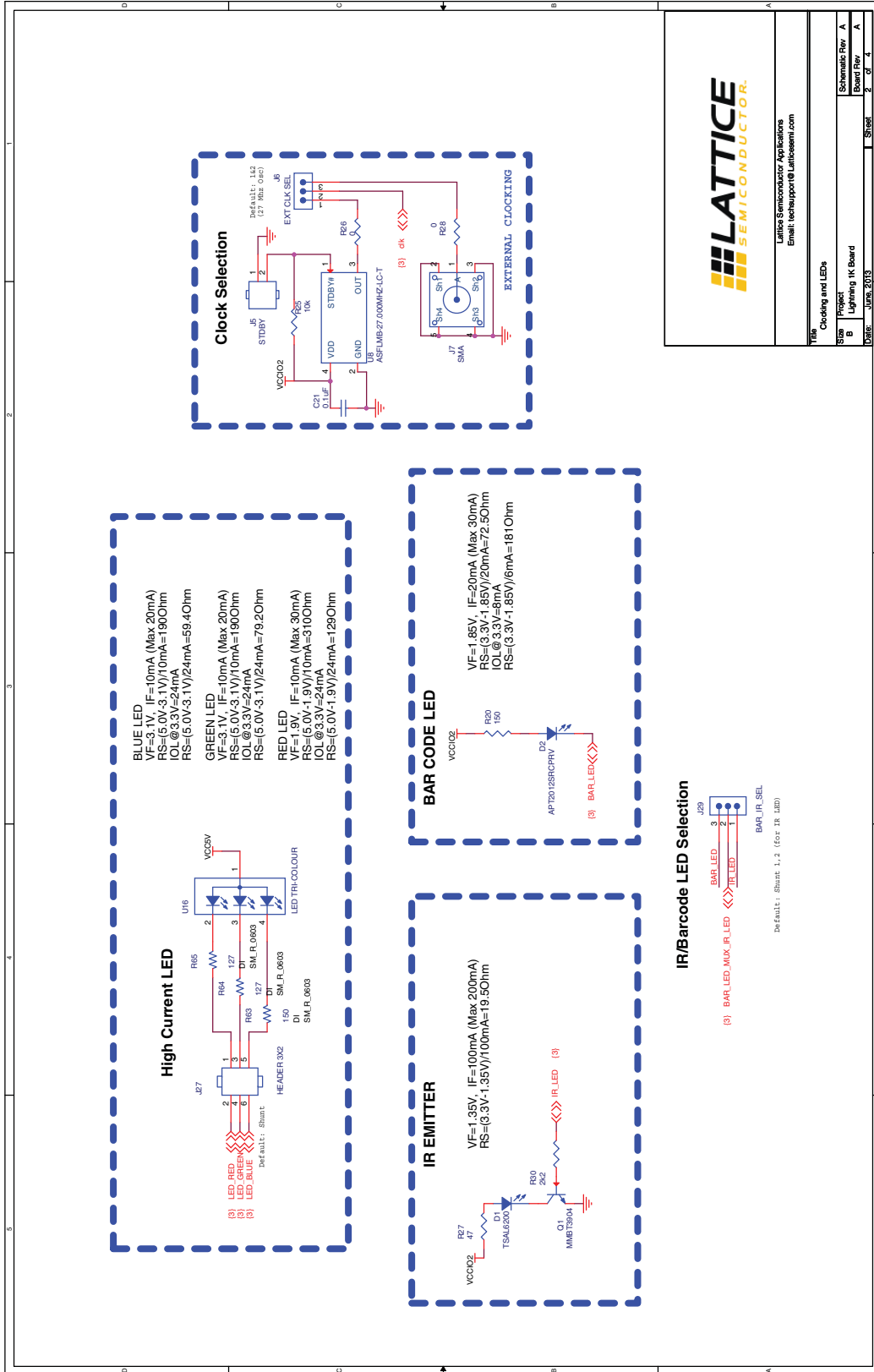

Figure 13. Clocking and LEDs



Lattice Semiconductor Applications
 Email: techsupport@lattice.com

Title	Clocking and LEDs
Project	Lighting 1K Board
Schema Rev	A
Board Rev	A
Date	June 2013
Sheet	2 of 4

Figure 14. Programming and Connectors

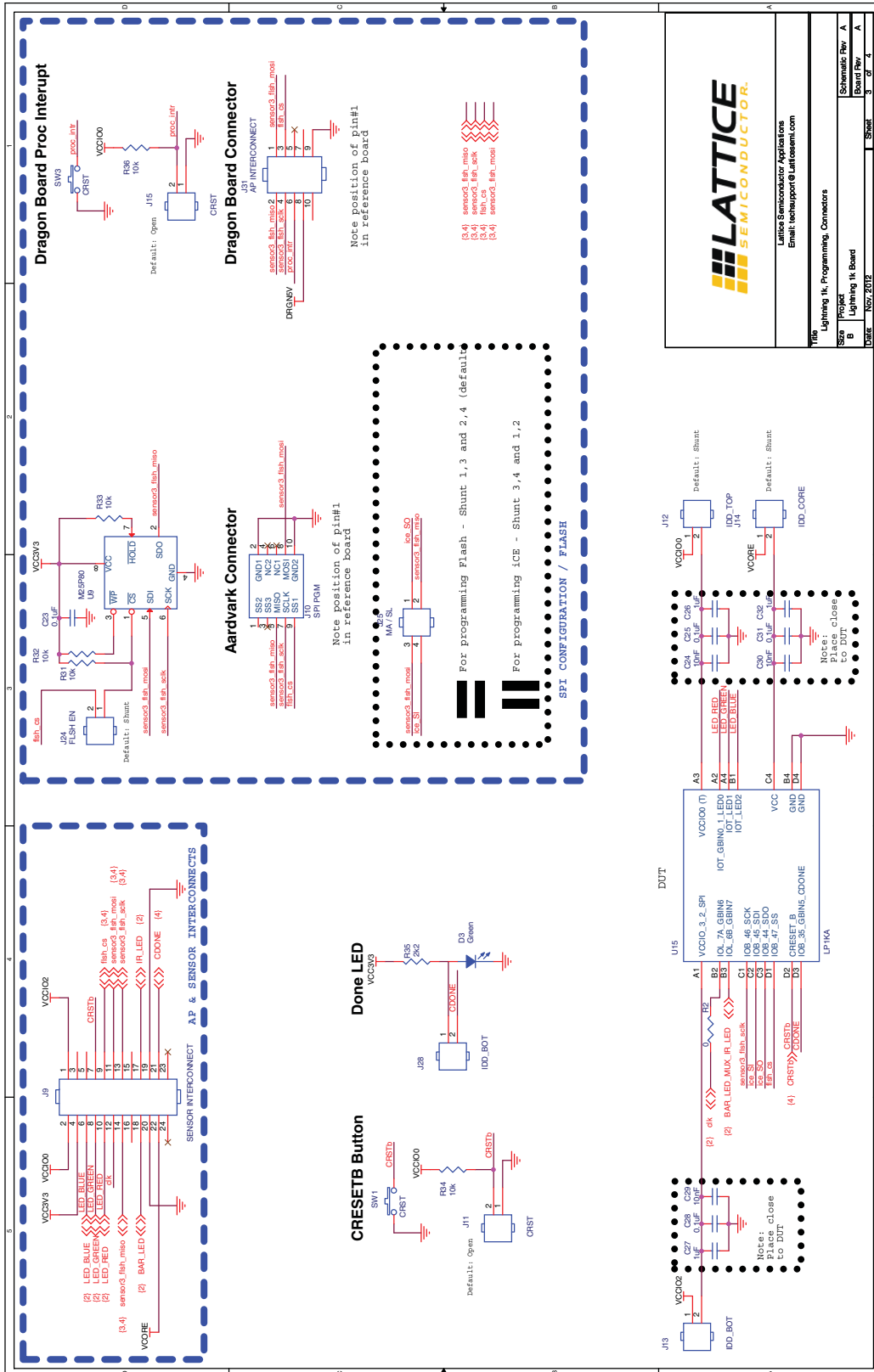
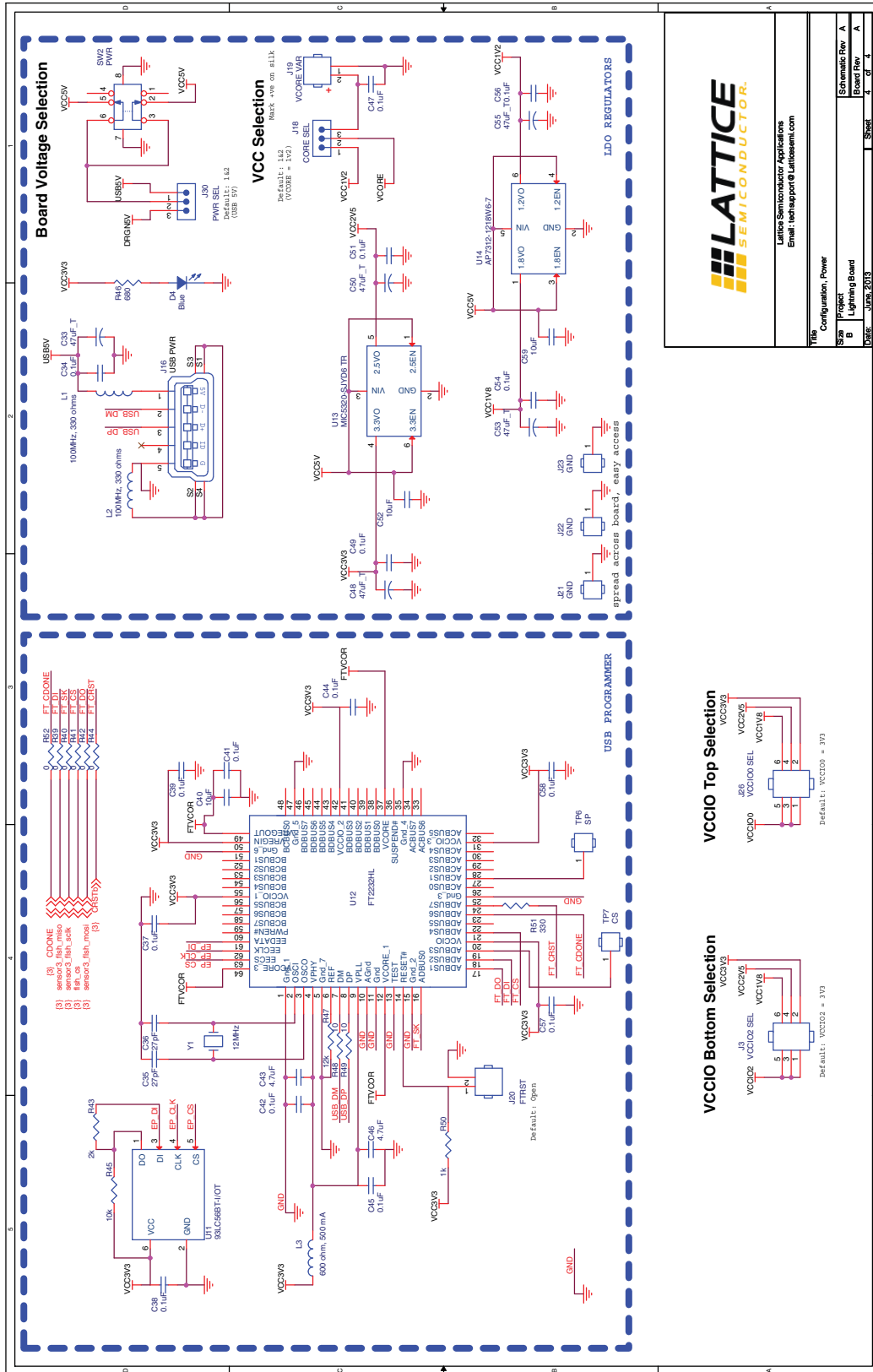

Figure 15. Configuration and Power



Lattice Semiconductor Applications
Email: techsupport@lattice.com

Title	Configuration - Power
Project	Lighting Board
Sheet	4 of 4
Date	June 2013
Schematic Rev	A
Board Rev	A

Appendix B. Bill of Materials

Item	Quantity	Reference	Value	PCB Footprint	Man. Part #	Manufacturer	Description	Populate
1	20	C21,C23,C25,C28,C31,C34,C37,C38,C39,C41,C42,C44,C45,C47,C49,C51,C54,C56,C57,C58	0.1uF	SM_C_0603	C1608X7R1E104K080AA	TDK Corp	CAP CER 0.1UF 25V 10% X7R 0603	DI
2	3	C24,C29,C30	10nF	SM_C_0603	ECJ-1VB1C103K	Panasonic	CAP CER 10000PF 16V 10% X7R 0603	DI
3	3	C26,C27,C32	1uF	SM_C_0603	0603X105K250CT	Walsin	CAPACITOR CER SMD 0603 1UF 25V X5R	DI
4	5	C33,C48,C50,C53,C55	47uF_T	SM_C_1411	293D476X9010B2TE3	Vishay/Sprague	CAP TANT 47UF 10V 10% 1411	DI
5	2	C35,C36	27pF	SM_C_0603	C0603C270J5GACTU	Kemet	CAP CER 27PF 50V 5% NP0 0603	DI
6	3	C40,C52,C59	10uF	SM_C_0805	08056C106KAT2A	AVX	CAP CER 10UF 6.3V 10% X7R 0805	DI
7	2	C43,C46	4.7uF	SM_C_0603	C1608X5R0J475K080AB	TDK Corp	CAP CER 4.7UF 6.3V 10% X5R 0603	DI
8	1	D1	TSAL6200	2p54_TH_LED	TSAL6200	Vishay	EMITTER IR 5MM HI EFF 940NM	DI
9	1	D2	APT2012SRCPRV	LED0805	APT2012SRCPRV	Kingbright Corp	LED 2X1.2MM 640NM RD WTR CLR SMD	DI
10	1	D3	Green	SM_D_0603	APT1608SGC	Kingbright Corp	LED 1.6X0.8MM 568NM GRN CLR SMD	DI
11	1	D4	Blue	SM_D_0603	LTST-C190TBKT	Lite-On Inc	LED BLUE CLEAR 0603 SMD	DI
12	1	J3	VCCIO2 SEL	HDR3x2	77313-801-06LF	FCI	CONN HEADER .100 DUAL STR 6POS	DI
13	1	J5	STDBY	HDR1X2-40	77311-801-02LF	FCI	CONN HEADER .100 SINGL STR 2POS	DI
14	1	J6	EXT CLK SEL	hdr1x3-40	77311-801-03LF	FCI	CONN HEADER .100 SINGL STR 3POS	DI
15	1	J7	SMA	conn_tp52r_smaver tmix	73391-0060	Molex	CONN SMA JACK STR 50 OHM PCB	DI
16	1	J9	SENSOR INTERCONNECT	HDR_12x2_2MM	87758-2416	Molex	CONN HEADER 24POS 2MM VERT GOLD	DI
17	1	J10	SPI PGM	hdr5x2	77313-801-10LF	FCI	CONN HEADER .100 DUAL STR 10POS	DI
18	2	J11,J15	CRST	HDR1X2-40	77311-801-02LF	FCI	CONN HEADER .100 SINGL STR 2POS	DI
19	1	J12	IDD_TOP	HDR1X2-40	77311-801-02LF	FCI	CONN HEADER .100 SINGL STR 2POS	DI
20	2	J13,J28	IDD_BOT	HDR1X2-40	77311-801-02LF	FCI	CONN HEADER .100 SINGL STR 2POS	DI
21	1	J14	IDD_CORE	HDR1X2-40	77311-801-02LF	FCI	CONN HEADER .100 SINGL STR 2POS	DI
22	1	J16	USB PWR	CONN_S5P1RMINI USBB_MOLEX	67503-1020	Molex	CONN RECEIPT MINIUSB R/A 5POS SMD	DI
23	1	J18	CORE SEL	hdr1x3-40	77311-801-03LF	FCI	CONN HEADER .100 SINGL STR 3POS	DI
24	1	J19	VCORE VAR	2pTB2p5mm	1770953	Phoenix Contact	CONN TERM BLK 2POS 2.5MM	DI
25	1	J20	FTRST	HDR1X2-40	77311-801-02LF	FCI	CONN HEADER .100 SINGL STR 2POS	DI
26	3	J21,J22,J23	GND	TUR_TH	1573-2	Keystone Electronics	TERMINAL TURRET DBL .082"L	DI
27	1	J24	FLSH EN	HDR1X2-40	77311-801-02LF	FCI	CONN HEADER .100 SINGL STR 2POS	DI
28	1	J25	MA / SL	hdr2x2	77313-801-04LF	FCI	CONN HEADER .100 DUAL STR 4POS	DI
29	1	J26	VCCIO0 SEL	HDR3x2	77313-801-06LF	FCI	CONN HEADER .100 DUAL STR 6POS	DI
30	1	J27	HEADER 3X2	HDR3x2	77313-801-06LF	FCI	CONN HEADER .100 DUAL STR 6POS	DI
31	1	J29	BAR_IR_SEL	hdr1x3-40	77311-801-03LF	FCI	CONN HEADER .100 SINGL STR 3POS	DI
32	1	J30	PWR SEL	hdr1x3-40	77311-801-03LF	FCI	CONN HEADER .100 SINGL STR 3POS	DI
33	1	J31	AP INTERCONNECT	HDR_5x2_2MM	087758-1016	Molex	CONN HEADER 10POS 2MM VERT GOLD	DI
34	2	L1,L2	100MHz, 330 ohms	L0603	MPZ1608S331A	TDK Corp	FERRITE CHIP 330 OHM 1.7A 0603	DI
35	1	L3	600 ohm, 500 mA	L0603	MMZ1608R601A	TDK Corp	FERRITE CHIP 600 OHM 500MA 0603	DI
36	1	Q1	MMBT3904	tot23_132_fc	MMBT3904,215	NXP	TRANS NPN 40V 200MA SOT23	DI
37	9	R2,R26,R28,R39,R40,R41,R42,R44,R52	0	R0603	WR06X000 PTL	Walsin	Resistor 0ohm JUMP 0603 SMD	DI
38	1	R20	150	R0603	WR06X151JTL	Walsin	Resistor 150 0603 +/-5% SMD	DI
39	7	R25,R31,R32,R33,R34,R36,R45	10k	R0603	WR06X103JTL	Walsin	Resistor 10K 0603 +/-5% SMD	DI
40	1	R27	47	R0805	WR08X470JTL	Walsin	Resistor 47 0805 +/-5% SMD	DI
41	2	R30,R35	2k2	R0603	WR06X222JTL	Walsin	Resistor 2.2K 0603 +/-5% SMD	DI
42	1	R43	2k	R0603	WR06X202JTL	Walsin	Resistor 2K 0603 +/-5% SMD	DI
43	1	R46	680	R0603	WR06X681JTL	Walsin	Resistor 680 0603 +/-5% SMD	DI
44	1	R47	12k	R0603	WR06X123JTL	Walsin	Resistor 12K 0603 +/-5% SMD	DI
45	2	R48,R49	10	R0603	WR06X100JTL	Walsin	Resistor 10 0603 +/-5% SMD	DI
46	1	R50	1k	R0603	WR06X102JTL	Walsin	Resistor 1K 0603 +/-5% SMD	DI
47	1	R51	330	R0603	WR06X331JTL	Walsin	Resistor 330 0603 +/-5% SMD	DI
48	1	R63	150	SM_R_0603	ERJ-3GEYJ151V	Panasonic	RES 150 OHM 1/10W 5% 0603 SMD	DI
49	2	R64,R65	127	SM_R_0603	CRCW0603127RFKEAHP	Vishay Dale	RES 127 OHM .25W 1% 0603 SMD	DI
50	2	SW1,SW3	CRST	2psmd_eswitch	TL1015AF160QG	E-Switch	SWITCH TACTILE SPST-NO 0.05A 12V	DI

Item	Quantity	Reference	Value	PCB Footprint	Man. Part #	Manufacturer	Description	Populate
51	1	SW2	PWR	dpdt_slide_sw_eg2 207	EG2207	E-Switch	SWITCH SLIDE DPDT .2A L=4MM	DI
52	1	TP6	SP	TP_TH_40_24	PCB PAD	PCB		DI
53	1	TP7	CS	TP_TH_40_24	PCB PAD	PCB		D
54	1	U8	ASFLMB- 27.000MHZ-LC-T	osc_5x3p2	ASFLMB-27.000MHZ-LC-T	ABRACON	OSC MEMS 27.000 MHZ SMD	DI
55	1	U9	M25P80	SOIC8-W	M25P80-VMW6TG	Micron Technology Inc	IC FLASH 8MBIT 75MHZ 8SO	DI
56	1	U11	93LC56BT-I/OT	SOT23-6	93LC56BT-I/OT	Microchip Technology	IC EEPROM 2KBIT 2MHZ SOT23-6	DI
57	1	U12	FT2232HL	tqfp64_0p5_12p2x1 2p2_h1p6	FT2232HL	FTDI	IC USB HS DUAL UART/FIFO 64-LQFP	DI
58	1	U13	MIC5320-SJYD6 TR	SOT23-6	MIC5320-SJYD6 TR	Mmicrel	IC REG LDO 3.3V/2.5V TSOT23-6	DI
59	1	U14	AP7312-1218W6- 7	SOT23-6	AP7312-1218W6-7	Diodes Inc	IC REG LDO 1.2V/1.8V 0.15A SOT2	DI
60'	1	U15	LP1KA	WLCSP16	LP1KA	Lattice Semiconductor	iCE1KA WLCSP16	DI
61	1	U16	LED TRI-COLOUR	THBTGFR421	THBTGFR421	Seoul Semicon- ductor	Tri Color LED 1.6 X 1.5 X 0.5 mm	DI
62	1	Y1	12MHz	5x3p2mm2p	ABM3-12.000MHZ-B2-T	Abrakon Corp	CRYSTAL 12.000MHZ 18PF SMD	DI
63	5	Rubber feet for board						
64		Lightning 1K Eval Board RevA PCB	305-PD-13-xxx					

1. Customer Supplied