

### Display ▪ Through-hole EADLBA10GA1

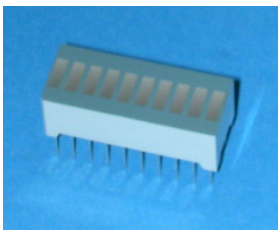

#### Features

- Industrial standard size.
- Low power consumption.
- Categorized for luminous intensity.
- Pb free and RoHS compliant.

#### Description

- The EADLBA10GA1 is a pattern display designed for viewing distances up to 7 meters.
- The display provides excellent reliability in bright ambient light.
- The device is made with white segments and gray surface.

#### Applications

- Home appliances
- Instrument panels
- Digital readout displays

## Device Selection Guide

| Chip Materials | Emitted Color          | Resin Color     |
|----------------|------------------------|-----------------|
| AlGaInP        | Brilliant Yellow Green | White Diffusion |

## Absolute Maximum Ratings (Ta=25°C)

| Parameter   | Symbol    | Rating     | Unit |
|---|-----------|------------|------|
| Reverse Voltage                                       | $V_R$     | 5          | V    |
| Forward Current                                       | $I_F$     | 25         | mA   |
| Peak Forward Current<br>(Duty 1/10 @1KHz)             | $I_{FP}$  | 60         | mA   |
| Power Dissipation                                     | $P_d$     | 60         | mW   |
| Operating Temperature                                 | $T_{opr}$ | -40 ~ +85  | °C   |
| Storage Temperature                                   | $T_{stg}$ | -40 ~ +100 | °C   |
| Soldering Temperature<br>(Soldering time ≤ 5 seconds) | $T_{sol}$ | 260        | °C   |

## Electro-Optical Characteristics (Ta=25°C)

| Parameter                         | Symbol          | Min.  | Typ.  | Max.  | Unit | Condition  |
|-----------------------------------|-----------------|-------|-------|-------|------|------------|
| Luminous Intensity <sup>**1</sup> | $I_v$           | 2.8   | 6.4   | ----- | mcd  | $I_F=10mA$ |
| Peak Wavelength                   | $\lambda_p$     | ----- | 575   | ----- | nm   | $I_F=20mA$ |
| Dominant Wavelength               | $\lambda_d$     | ----- | 573   | ----- | nm   | $I_F=20mA$ |
| Spectrum Radiation Bandwidth      | $\Delta\lambda$ | ----- | 20    | ----- | nm   | $I_F=20mA$ |
| Forward Voltage                   | $V_F$           | ----- | 2.0   | 2.4   | V    | $I_F=20mA$ |
| Reverse Current                   | $I_R$           | ----- | ----- | 100   | μA   | $V_R=5V$   |

Note:

1. Tolerance of Luminous Intensity: ± 10 %
2. Tolerance of Forward Voltage: ± 0.1V

**Typical Electro-Optical Characteristics Curves**

**Spectrum Distribution (Ta=25°C)**

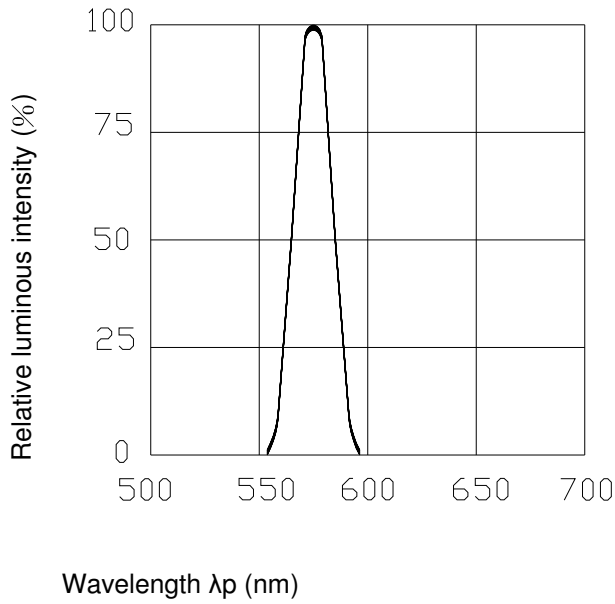

**Forward Current vs. Forward Voltage (Ta=25°C)**

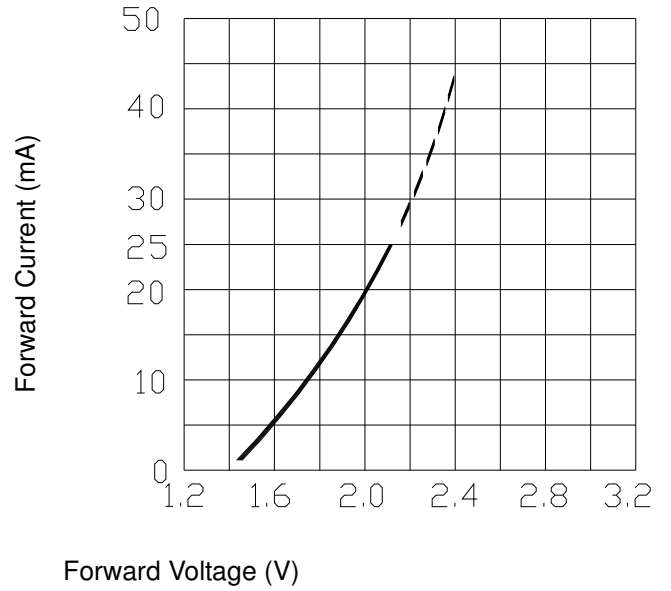

**Forward Current Derating Curve**

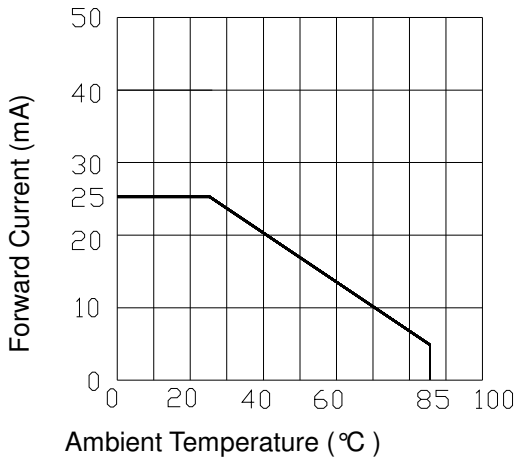

**Package Dimension & Internal Circuit Diagram**

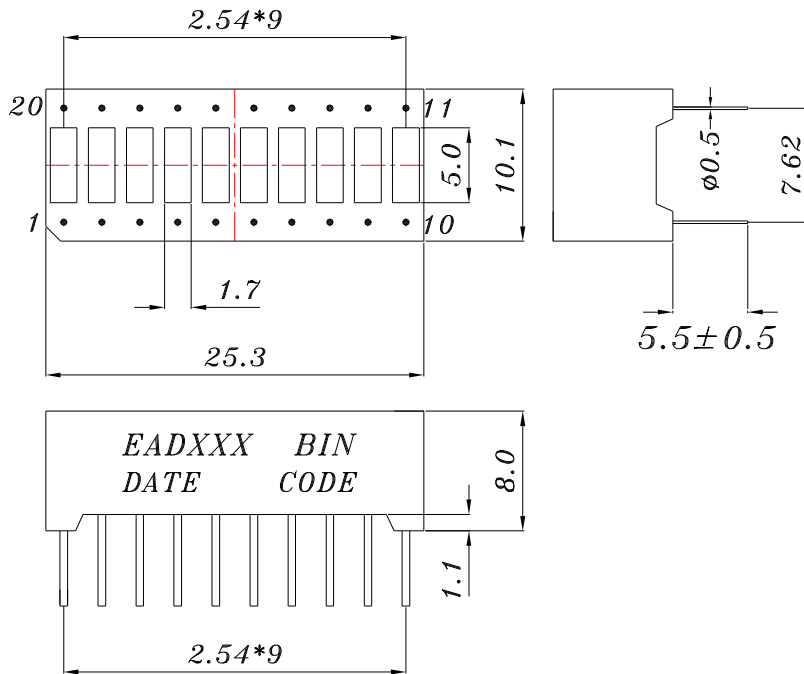

- 1 ANODE BAR 1
- 2 ANODE BAR 2
- 3 ANODE BAR 3
- 4 ANODE BAR 4
- 5 ANODE BAR 5
- 6 ANODE BAR 6
- 7 ANODE BAR 7
- 8 ANODE BAR 8
- 9 ANODE BAR 9
- 10 ANODE BAR 10
- 11 CATHODE BAR 10
- 12 CATHODE BAR 9
- 13 CATHODE BAR 8
- 14 CATHODE BAR 7
- 15 CATHODE BAR 6
- 16 CATHODE BAR 5
- 17 CATHODE BAR 4
- 18 CATHODE BAR 3
- 19 CATHODE BAR 2
- 20 CATHODE BAR 1

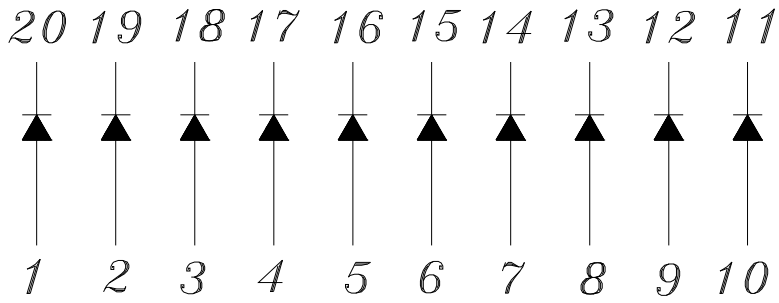

Note: Tolerances unless mentioned  $\pm 0.25$ mm. Unit = mm

## Packing Materials

### Label Explanation

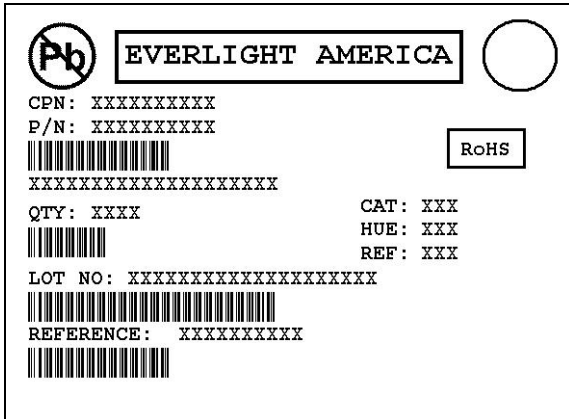

- CPN: Customer's Product Number
- P/N: Product Number
- QTY: Packing Quantity
- CAT: Luminous Intensity Rank
- HUE: Reference
- REF: Reference
- LOT No: Lot Number
- REFERENCE: Volume Label code

### Packing Process

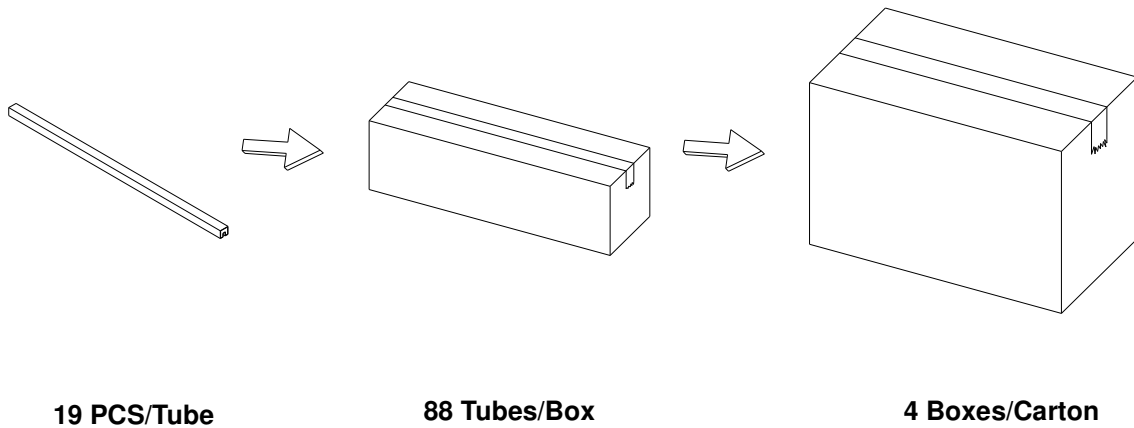

## Application Restrictions

1. Specification described in this document. Above specification may be changed without notice. EVERLIGHT Americas will reserve authority on material change for above specification.
2. When using this product, please observe the absolute maximum ratings and the instructions for using outlined in these specification sheets. EVERLIGHT Americas assumes no responsibility for any damage resulting from use of the product which does not comply with the absolute maximum ratings and the instructions included in these specification sheets.
3. These specification sheets include materials protected under copyright of EVERLIGHT Americas Corporation. Please don't reproduce or cause anyone to reproduce them without EVERLIGHT Americas' consent.
4. ESD (Electrostatic Discharge)
  - The products are sensitive to static electricity or surge voltage. ESD can damage a die and its reliability. When handling the products, the following measures against electrostatic discharge are strongly recommended:
    - Eliminating the charge
    - Grounded wrist strap, ESD footwear, clothes, and floors
    - Grounded workstation equipment and tools
    - ESD table/shelf mat made of conductive materials
  - Proper grounding is required for all devices, equipment, and machinery used in product assembly. Surge protection should be considered when designing of commercial products.
  - If tools or equipment contain insulating materials such as glass or plastic, the following measures against electrostatic discharge are strongly recommended:
    - Dissipating static charge with conductive materials
    - Preventing charge generation with moisture
    - Neutralizing the charge with ionizers
5. The LEDs should be operated with forward bias. The driving circuit must be designed so that the LEDs are not subjected to forward or reverse voltage while it is off. If reverse voltage is continuously applied to the LEDs, it may cause migration resulting in LED damage.