

Enclosures can be Factory Modified (Milling, Drilling, Printing etc.)
 Contact Factory mjm@hammondmfg.com for quotes

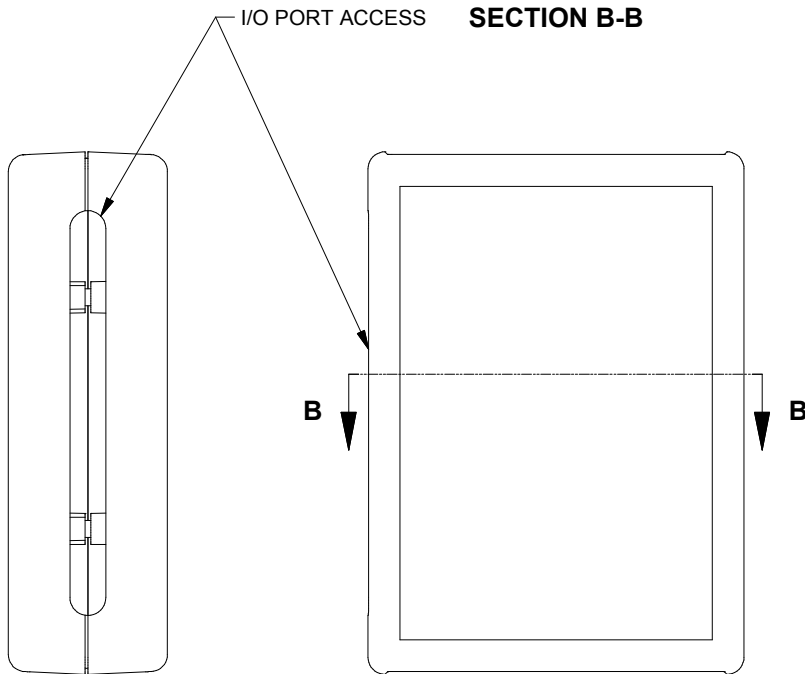

ASSEMBLY - VIEW FROM TOP SIDE

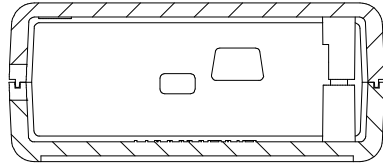
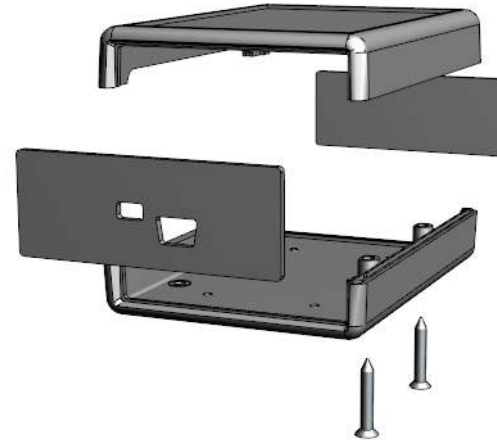
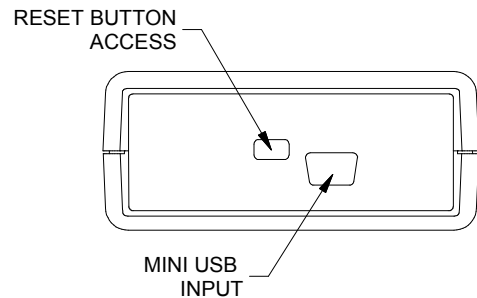

NOTE: ENCLOSURE SUPPLIED WITH 4 COVER SCREWS,
 ONLY 2 COVER SCREWS REQUIRED FOR ASSEMBLY

NOTE: 1593FREE1 ENCLOSURE IS BASED ON HAMMOND STANDARD 1593L
 PLEASE SEE 1593L DRAWING FOR STANDARD ENCLOSURE SPECIFICATIONS

NOTE

Purchased assembly includes top and bottom cover, front and rear end panels, 4 cover screws, and 5 rubber feet (P.C. Board not included)
 Enclosure molded from ABS Plastic.

PART NUMBERS

1593HAMFREE1 Enclosure	
Black Enclosure	1593HAMFREE1BK
Grey Enclosure	1593HAMFREE1GY
Translucent Blue Enclosure	1593HAMFREE1TBU

Dimensions:
 mm
 [inches]

