

PART NO.	A97009-004	REV	ECO	DATE	APP
		A	104704	08-03-18	TLM

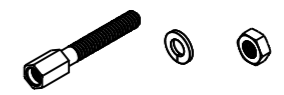

ACTUAL SIZE

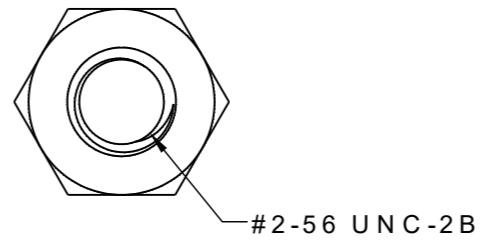
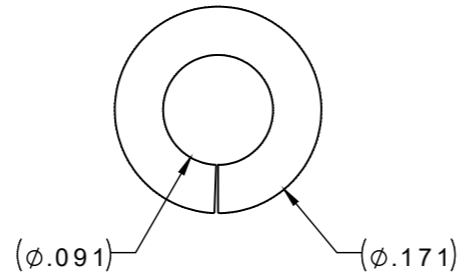
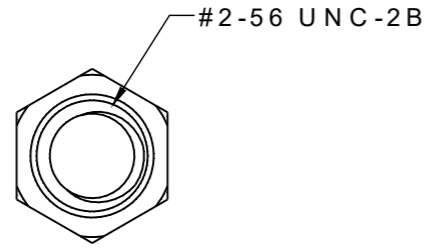
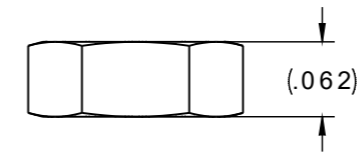
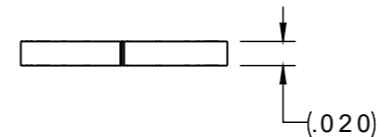
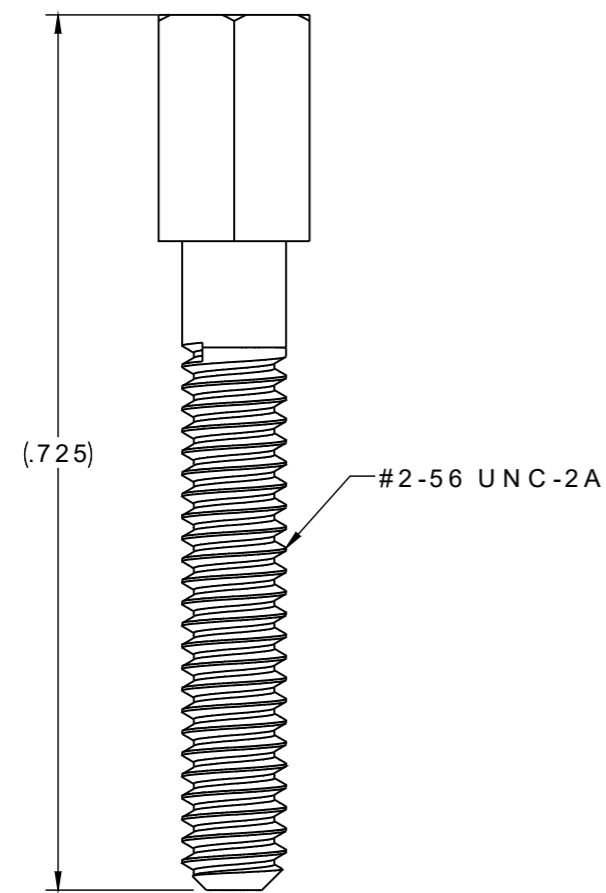

NOTE:  
KIT INCLUDES TWO (2) OF EACH COMPONENT

XXX SLDW	THIRD ANGLE		THIS DRAWING CONTAINS CONFIDENTIAL AND PROPRIETARY INFORMATION WHICH IS THE PROPERTY OF OMNETICS CONNECTOR CORP. THIS DOCUMENT MAY NOT, IN WHOLE OR IN PART, BE DUPLICATED, OR DISCLOSED FOR ANY PURPOSE, WITHOUT WRITTEN PERMISSION FROM OMNETICS CONNECTOR CORP.		<b>OMNETICS</b> CONNECTOR CORPORATION 7260 COMMERCE CIRCLE EAST MINNEAPOLIS, MN 55432 WWW.OMNETICS.COM	CAGE CODE 61873		
	-TOLERANCES-		DFTM. EDG	DATE 07-31-18		TITLE: KIT, JACKPOST OPTION 01	DWG NO. A97009-004	
	UNLESS OTHERWISE NOTED		CHK'D.	DATE			SHEET 1 OF 1	
	DIMENSIONS IN INCHES		APP'D.	DATE			REV A	
	2 PL DEC ± .01				SCALE: 6:1			
	3 PL DEC ± .005							
	4 PL DEC ± .0005							
	ANGLES ± 1°							