

Switching

SP8M3

●Features

- 1) Low on-resistance.
- 2) Built-in G-S Protection Diode.
- 3) Small and Surface Mount Package (SOP8).

●Application

Power switching, DC / DC converter.

●External dimensions (Unit : mm)

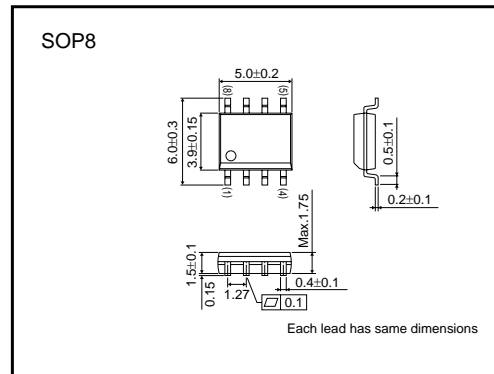

●Absolute maximum ratings (Ta=25°C)

Parameter	Symbol	Limits		Unit
		Nchannel	Pchannel	
Drain-source voltage	V _{DSS}	30	-30	V
Gate-source voltage	V _{GSS}	20	-20	V
Drain current	Continuous	I _D	±5.0	A
	Pulsed	I _{DP}	±20	A *1
Source current (Body diode)	Continuous	I _S	1.6	A
	Pulsed	I _{SP}	-1.6	A *1
Total power dissipation	P _D	2		W *2
Channel temperature	T _{ch}	150		°C
Storage temperature	T _{stg}	-55 to +150		°C

*1 Pw≤10μs, Duty cycles1%
*2 MOUNTED ON A CERAMIC BOARD.

●Equivalent circuit

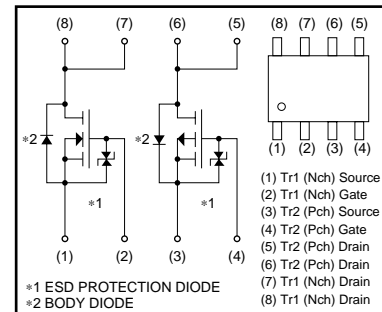

*A protection diode is included between the gate and the source terminals to protect the diode against static electricity when the product is in use. Use the protection circuit when the fixed voltages are exceeded.

●Thermal resistance (Ta=25°C)

Parameter	Symbol	Limits	Unit
Channel to ambient	R _{th (ch-a)}	62.5	°C / W *

*MOUNTED ON A CERAMIC BOARD.

Transistors

N-ch

●Electrical characteristics (Ta=25°C)

Parameter	Symbol	Min.	Typ.	Max.	Unit	Conditions
Gate-source leakage	I _{GSS}	–	–	10	μA	V _{GS} =20V, V _{DS} =0V
Drain-source breakdown voltage	V _{(BR) DSS}	30	–	–	V	I _D =1mA, V _{GS} =0V
Zero gate voltage drain current	I _{DSS}	–	–	1	μA	V _{DS} =30V, V _{GS} =0V
Gate threshold voltage	V _{GS(th)}	1.0	–	2.5	V	V _{DS} =10V, I _D =1mA
Static drain-source on-state resistance	R _{DS(on)}	–	36	51	mΩ	I _D =5.0A, V _{GS} =10V
		–	52	73		I _D =5.0A, V _{GS} =4.5V
		–	58	82		I _D =5.0A, V _{GS} =4V
Forward transfer admittance	Y _{fs}	3.0	–	–	S	I _D =5.0A, V _{DS} =10V
Input capacitance	C _{iss}	–	230	–	pF	V _{DS} =10V
Output capacitance	C _{oss}	–	80	–	pF	V _{GS} =0V
Reverse transfer capacitance	C _{rss}	–	50	–	pF	f=1MHz
Turn-on delay time	t _{d(on)}	–	6	–	ns	I _D =2.5A, V _{DD} ≐15V
Rise time	t _r	–	8	–	ns	V _{GS} =10V
Turn-off delay time	t _{d(off)}	–	22	–	ns	R _L =6.0Ω
Fall time	t _f	–	5	–	ns	R _G =10Ω
Total gate charge	Q _g	–	3.9	5.5	nC	V _{DD} ≐15V
Gate-source charge	Q _{gs}	–	1.1	–	nC	V _{GS} =5V
Gate-drain charge	Q _{gd}	–	1.4	–	nC	I _D =5.0A

*Pulsed

●Body diode characteristics (Source-Drain Characteristics) (Ta=25°C)

Parameter	Symbol	Min.	Typ.	Max.	Unit	Conditions
Forward voltage	V _{SD}	–	–	1.2	V	I _S =6.4A, V _{GS} =0V

*Pulsed

Transistors

P-ch

●Electrical characteristics (Ta=25°C)

Parameter	Symbol	Min.	Typ.	Max.	Unit	Conditions
Gate-source leakage	I_{GSS}	–	–	–10	μA	$V_{GS} = -20V, V_{DS} = 0V$
Drain-source breakdown voltage	$V_{(BR) DSS}$	–30	–	–	V	$I_D = -1mA, V_{GS} = 0V$
Zero gate voltage drain current	I_{DSS}	–	–	–1	μA	$V_{DS} = -30V, V_{GS} = 0V$
Gate threshold voltage	$V_{GS(th)}$	–1.0	–	–2.5	V	$V_{DS} = -10V, I_D = -1mA$
Static drain-source on-state resistance	$R_{DS(on)}$	–	40	56	m Ω	$I_D = -4.5A, V_{GS} = -10V$ *
		–	57	80		$I_D = -2.5A, V_{GS} = -4.5V$ *
		–	65	90		$I_D = -2.5A, V_{GS} = -4.0V$ *
Forward transfer admittance	$ Y_{fs} $	3.5	–	–	S	$I_D = -2.5A, V_{DS} = -10V$ *
Input capacitance	C_{iss}	–	850	–	pF	$V_{DS} = -10V$
Output capacitance	C_{oss}	–	190	–	pF	$V_{GS} = 0V$
Reverse transfer capacitance	C_{rss}	–	120	–	pF	$f = 1MHz$
Turn-on delay time	$t_{d(on)}$	–	10	–	ns	$I_D = -2.5A, V_{DD} \doteq -15V$ *
Rise time	t_r	–	25	–	ns	$V_{GS} = -10V$ *
Turn-off delay time	$t_{d(off)}$	–	60	–	ns	$R_L = 6.0\Omega$ *
Fall time	t_f	–	25	–	ns	$R_G = 10\Omega$ *
Total gate charge	Q_g	–	8.5	–	nC	$V_{DD} \doteq -15V$ *
Gate-source charge	Q_{gs}	–	2.5	–	nC	$V_{GS} = -5V$ *
Gate-drain charge	Q_{gd}	–	3.0	–	nC	$I_D = -4.5A$ *

*Pulsed

●Body diode characteristics (Source-Drain Characteristics) (Ta=25°C)

Parameter	Symbol	Min.	Typ.	Max.	Unit	Conditions
Forward voltage	V_{SD}	–	–	–1.2	V	$I_S = -1.6A, V_{GS} = 0V$ *

*Pulsed

Transistors

N-ch

●Electrical characteristic curves

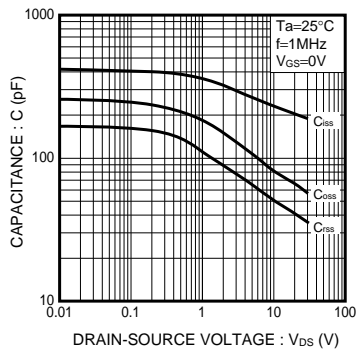

Fig.1 Typical Capacitance vs. Drain-Source Voltage

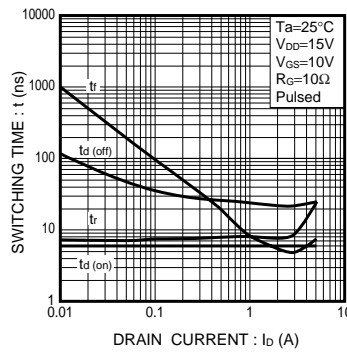

Fig.2 Switching Characteristics

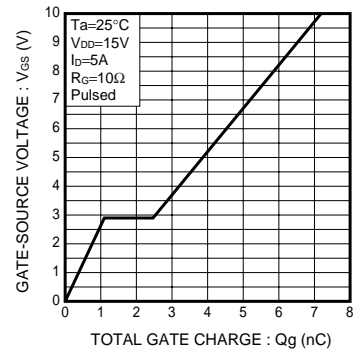

Fig.3 Dynamic Input Characteristics

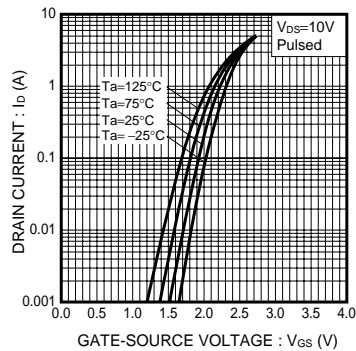

Fig.4 Typical Transfer Characteristics

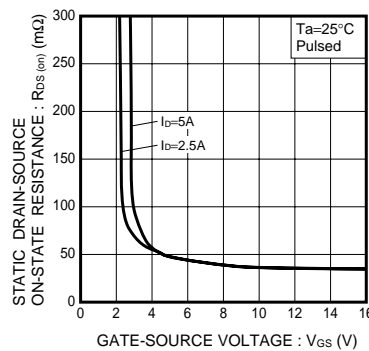

Fig.5 Static Drain-Source On-State Resistance vs. Gate-Source Voltage

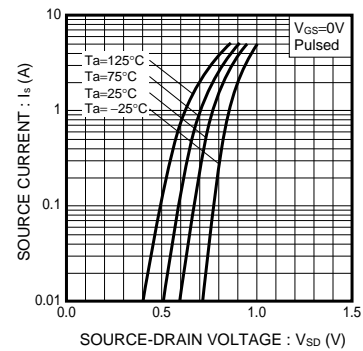

Fig.6 Source Current vs. Source-Drain Voltage

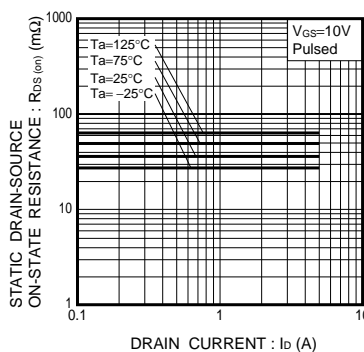

Fig.7 Static Drain-Source On-State Resistance vs. Drain Current (I)

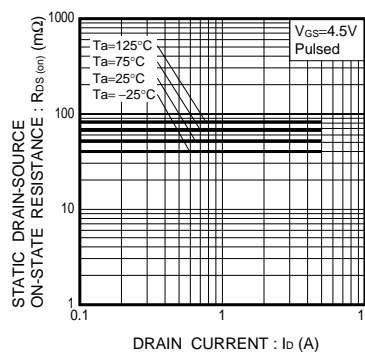

Fig.8 Static Drain-Source On-State Resistance vs. Drain Current (II)

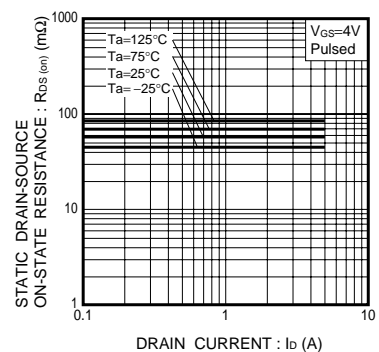

Fig.9 Static Drain-Source On-State Resistance vs. Drain Current (III)

Transistors

P-ch

●Electrical characteristic curves

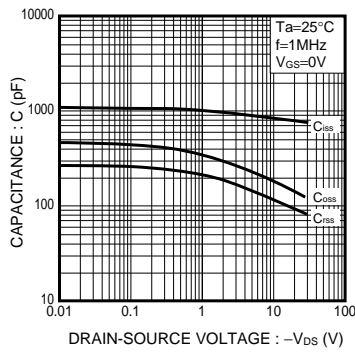

Fig.1 Typical Capacitance vs. Drain-Source Voltage

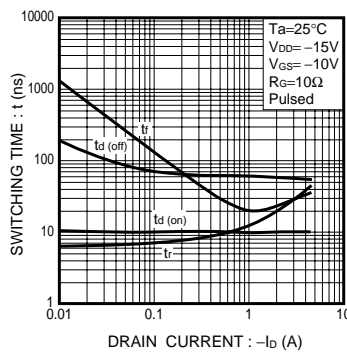

Fig.2 Switching Characteristics

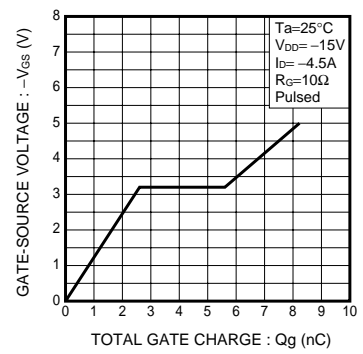

Fig.3 Dynamic Input Characteristics

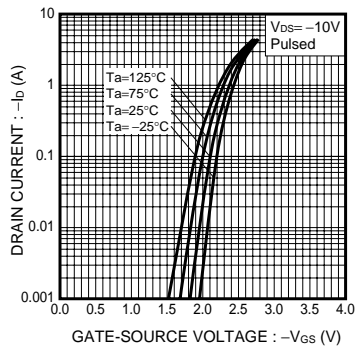

Fig.4 Typical Transfer Characteristics

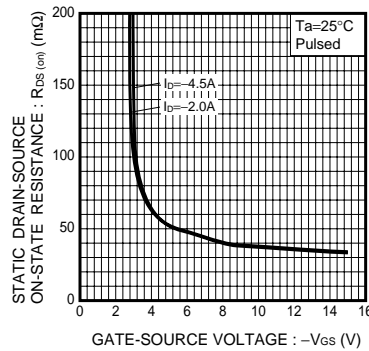

Fig.5 Static Drain-Source On-State Resistance vs. Gate-Source Voltage

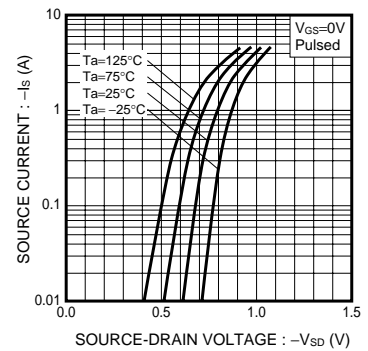

Fig.6 Source Current vs. Source-Drain Voltage

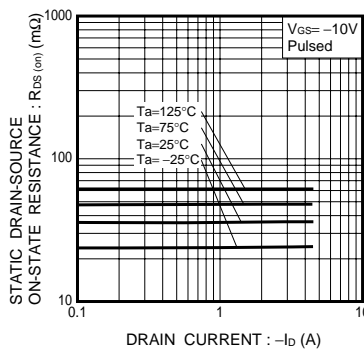

Fig.7 Static Drain-Source On-State Resistance vs. Drain Current (I)

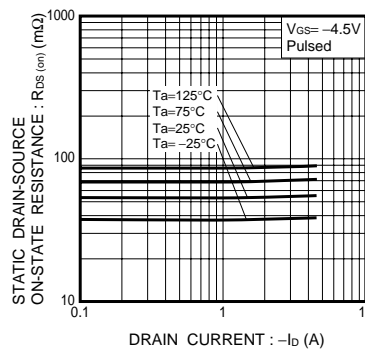

Fig.8 Static Drain-Source On-State Resistance vs. Drain Current (II)

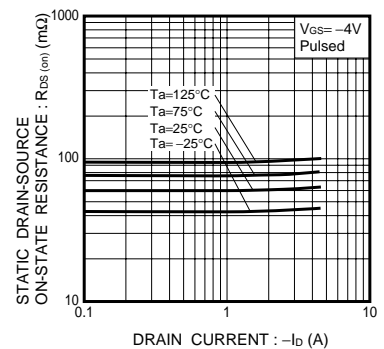

Fig.9 Static Drain-Source On-State Resistance vs. Drain Current (III)

Notes

- No technical content pages of this document may be reproduced in any form or transmitted by any means without prior permission of ROHM CO.,LTD.
- The contents described herein are subject to change without notice. The specifications for the product described in this document are for reference only. Upon actual use, therefore, please request that specifications to be separately delivered.
- Application circuit diagrams and circuit constants contained herein are shown as examples of standard use and operation. Please pay careful attention to the peripheral conditions when designing circuits and deciding upon circuit constants in the set.
- Any data, including, but not limited to application circuit diagrams information, described herein are intended only as illustrations of such devices and not as the specifications for such devices. ROHM CO.,LTD. disclaims any warranty that any use of such devices shall be free from infringement of any third party's intellectual property rights or other proprietary rights, and further, assumes no liability of whatsoever nature in the event of any such infringement, or arising from or connected with or related to the use of such devices.
- Upon the sale of any such devices, other than for buyer's right to use such devices itself, resell or otherwise dispose of the same, no express or implied right or license to practice or commercially exploit any intellectual property rights or other proprietary rights owned or controlled by
- ROHM CO., LTD. is granted to any such buyer.
- Products listed in this document are no antiradiation design.

The products listed in this document are designed to be used with ordinary electronic equipment or devices (such as audio visual equipment, office-automation equipment, communications devices, electrical appliances and electronic toys).

Should you intend to use these products with equipment or devices which require an extremely high level of reliability and the malfunction of which would directly endanger human life (such as medical instruments, transportation equipment, aerospace machinery, nuclear-reactor controllers, fuel controllers and other safety devices), please be sure to consult with our sales representative in advance.

About Export Control Order in Japan

Products described herein are the objects of controlled goods in Annex 1 (Item 16) of Export Trade Control Order in Japan.

In case of export from Japan, please confirm if it applies to "objective" criteria or an "informed" (by MITI clause) on the basis of "catch all controls for Non-Proliferation of Weapons of Mass Destruction.