

HiPerFET™ Power MOSFETs Q-CLASS

IXFK 27N80Q
IXFR 27N80Q
IXFX 27N80Q

$V_{DSS} = 800\text{ V}$
 $I_{D25} = 27\text{ A}$
 $R_{DS(on)} = 300\text{ m}\Omega$

Single MOSFET Die

$t_{rr} \leq 250\text{ ns}$

N-Channel Enhancement Mode
Avalanche Rated, Low Q_g , High dV/dt , Low t_{rr}

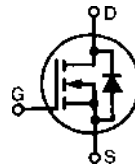

| Symbol | Test Conditions | Maximum Ratings | |
|-----------|---|----------------------|------------------|
| V_{DSS} | $T_J = 25^\circ\text{C}$ to 150°C | 800 | V |
| V_{DGR} | $T_J = 25^\circ\text{C}$ to 150°C ; $R_{GS} = 1\text{ M}\Omega$ | 800 | V |
| V_{GS} | Continuous | ± 20 | V |
| V_{GSM} | Transient | ± 30 | V |
| I_{D25} | $T_C = 25^\circ\text{C}$ | 27 | A |
| I_{DM} | $T_C = 25^\circ\text{C}$, pulse width limited by T_{JM} | 108 | A |
| I_{AR} | $T_C = 25^\circ\text{C}$ | 27 | A |
| E_{AR} | $T_C = 25^\circ\text{C}$ | 60 | mJ |
| E_{AS} | $T_C = 25^\circ\text{C}$ | 2.5 | J |
| dv/dt | $I_S \leq I_{DM}$, $di/dt \leq 100\text{ A}/\mu\text{s}$, $V_{DD} \leq V_{DSS}$ $T_J \leq 150^\circ\text{C}$, $R_G = 2\ \Omega$ | 5 | V/ns |
| P_D | $T_C = 25^\circ\text{C}$ | 500 | W |
| T_J | | -55 ... +150 | $^\circ\text{C}$ |
| T_{JM} | | 150 | $^\circ\text{C}$ |
| T_{stg} | | -55 ... +150 | $^\circ\text{C}$ |
| T_L | 1.6 mm (0.063 in.) from case for 10 s | 300 | $^\circ\text{C}$ |
| M_d | Mounting torque | TO-264 | 0.4/6 Nm/lb.in. |
| Weight | | PLUS 247/ISOPLUS 247 | 6 g |
| | | TO-264 | 10 g |

PLUS 247™ (IXFX)

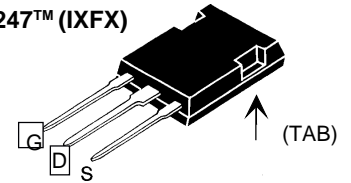

TO-264 AA (IXFK)

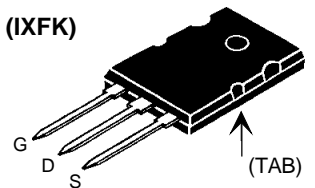

ISOPLUS 247™ (IXFR)
E153432

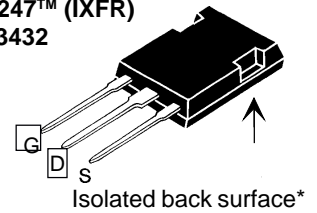

G = Gate
S = Source

D = Drain
TAB = Drain

Features

- IXYS advanced low Q_g process
- Low gate charge and capacitances
 - easier to drive
 - faster switching
- International standard packages
- Low $R_{DS(on)}$
- Rated for unclamped Inductive load switching (UIS) rated
- Molding epoxies meet UL 94 V-0 flammability classification

Applications

- DC-DC converters
- Battery chargers
- Switched-mode and resonant-mode power supplies
- DC choppers
- AC motor control
- Temperature and lighting controls

Advantages

- PLUS 247™ package for clip or spring mounting
- Space savings
- High power density

| Symbol | Test Conditions | Characteristic Values ($T_J = 25^\circ\text{C}$, unless otherwise specified) | | |
|--------------|--|---|------|---------------------------|
| | | min. | typ. | max. |
| V_{DSS} | $V_{GS} = 0\text{ V}$, $I_D = 250\mu\text{A}$ | 800 | | V |
| $V_{GS(th)}$ | $V_{DS} = V_{GS}$, $I_D = 4\text{ mA}$ | 2.0 | | 4.5 V |
| I_{GSS} | $V_{GS} = \pm 20\text{ V}$, $V_{DS} = 0$ | | | $\pm 100\text{ nA}$ |
| I_{DSS} | $V_{DS} = V_{DSS}$ $V_{GS} = 0\text{ V}$ | | | 100 μA 2 mA |
| $R_{DS(on)}$ | $V_{GS} = 10\text{ V}$, $I_D = 0.5 \cdot I_{D25}$ Note 1 | | | 300 $\text{m}\Omega$ |

| Symbol | Test Conditions | Characteristic Values ($T_J = 25^\circ\text{C}$, unless otherwise specified) | | |
|--------------|--|---|------|------|
| | | min. | typ. | max. |
| g_{fs} | $V_{DS} = 10\text{ V}; I_D = 0.5 \cdot I_{D25}$ Note 1 | 20 | 27 | S |
| C_{iss} | $V_{GS} = 0\text{ V}, V_{DS} = 25\text{ V}, f = 1\text{ MHz}$ | | 7600 | pF |
| C_{oss} | | | 750 | pF |
| C_{rss} | | | 120 | pF |
| $t_{d(on)}$ | $V_{GS} = 10\text{ V}, V_{DS} = 0.5 \cdot V_{DSS}, I_D = 0.5 \cdot I_{D25}$ $R_G = 1\ \Omega$ (External), | | 20 | ns |
| t_r | | | 28 | ns |
| $t_{d(off)}$ | | | 50 | ns |
| t_f | | | 13 | ns |
| $Q_{g(on)}$ | $V_{GS} = 10\text{ V}, V_{DS} = 0.5 \cdot V_{DSS}, I_D = 0.5 \cdot I_{D25}$ | | 170 | nC |
| Q_{gs} | | | 47 | nC |
| Q_{gd} | | | 65 | nC |
| R_{thJC} | | | 0.26 | K/W |
| R_{thCK} | | 0.15 | | K/W |

| Symbol | Test Conditions | Characteristic Values ($T_J = 25^\circ\text{C}$, unless otherwise specified) | | |
|----------|--|---|------|---------------|
| | | min. | typ. | max. |
| I_S | $V_{GS} = 0\text{ V}$ | | | 27 A |
| I_{SM} | Repetitive; pulse width limited by T_{JM} | | | 108 A |
| V_{SD} | $I_F = I_S, V_{GS} = 0\text{ V}$, Note 1 | | | 1.5 V |
| t_{rr} | $I_F = I_S, -di/dt = 100\text{ A}/\mu\text{s}, V_R = 100\text{ V}$ | | | 250 ns |
| Q_{RM} | | | 1.3 | μC |
| I_{RM} | | | 8 | A |

Note: 1. Pulse test, $t \leq 300\ \mu\text{s}$, duty cycle $d \leq 2\%$

ISOPLUS 247 (IXFR) OUTLINE

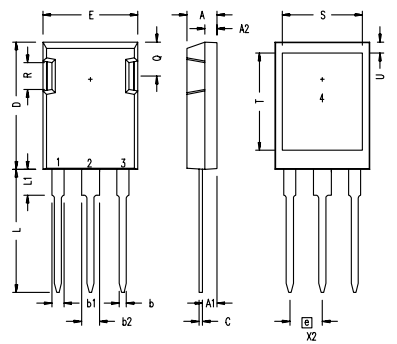

1 Gate, 2 Drain (Collector)
3 Source (Emitter)
4 no connection

| Dim. | Millimeter | | Inches | |
|----------------|------------|-------|----------|------|
| | Min. | Max. | Min. | Max. |
| A | 4.83 | 5.21 | .190 | .205 |
| A ₁ | 2.29 | 2.54 | .090 | .100 |
| A ₂ | 1.91 | 2.16 | .075 | .085 |
| b | 1.14 | 1.40 | .045 | .055 |
| b ₁ | 1.91 | 2.13 | .075 | .084 |
| b ₂ | 2.92 | 3.12 | .115 | .123 |
| C | 0.61 | 0.80 | .024 | .031 |
| D | 20.80 | 21.34 | .819 | .840 |
| E | 15.75 | 16.13 | .620 | .635 |
| e | 5.45 BSC | | .215 BSC | |
| L | 19.81 | 20.32 | .780 | .800 |
| L1 | 3.81 | 4.32 | .150 | .170 |
| Q | 5.59 | 6.20 | .220 | .244 |
| R | 4.32 | 4.83 | .170 | .190 |
| S | 13.21 | 13.72 | .520 | .540 |
| T | 15.75 | 16.26 | .620 | .640 |
| U | 1.65 | 3.03 | .065 | .080 |

TO-264 AA (IXFK) Outline

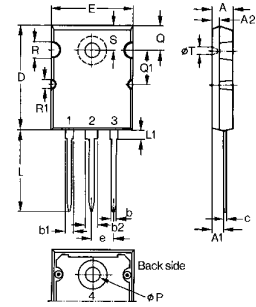

| Dim. | Millimeter | | Inches | |
|------|------------|-------|----------|-------|
| | Min. | Max. | Min. | Max. |
| A | 4.82 | 5.13 | .190 | .202 |
| A1 | 2.54 | 2.89 | .100 | .114 |
| A2 | 2.00 | 2.10 | .079 | .083 |
| b | 1.12 | 1.42 | .044 | .056 |
| b1 | 2.39 | 2.69 | .094 | .106 |
| b2 | 2.90 | 3.09 | .114 | .122 |
| c | 0.53 | 0.83 | .021 | .033 |
| D | 25.91 | 26.16 | 1.020 | 1.030 |
| E | 19.81 | 19.96 | .780 | .786 |
| e | 5.46 BSC | | .215 BSC | |
| J | 0.00 | 0.25 | .000 | .010 |
| K | 0.00 | 0.25 | .000 | .010 |
| L | 20.32 | 20.83 | .800 | .820 |
| L1 | 2.29 | 2.59 | .090 | .102 |
| P | 3.17 | 3.66 | .125 | .144 |
| Q | 6.07 | 6.27 | .239 | .247 |
| Q1 | 8.38 | 8.69 | .330 | .342 |
| R | 3.81 | 4.32 | .150 | .170 |
| R1 | 1.78 | 2.29 | .070 | .090 |
| S | 6.04 | 6.30 | .238 | .248 |
| T | 1.57 | 1.83 | .062 | .072 |

PLUS247™ (IXFX) Outline

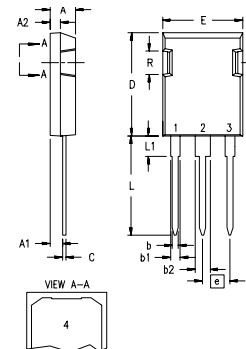

| Dim. | Millimeter | | Inches | |
|----------------|------------|-------|----------|------|
| | Min. | Max. | Min. | Max. |
| A | 4.83 | 5.21 | .190 | .205 |
| A ₁ | 2.29 | 2.54 | .090 | .100 |
| A ₂ | 1.91 | 2.16 | .075 | .085 |
| b | 1.14 | 1.40 | .045 | .055 |
| b ₁ | 1.91 | 2.13 | .075 | .084 |
| b ₂ | 2.92 | 3.12 | .115 | .123 |
| C | 0.61 | 0.80 | .024 | .031 |
| D | 20.80 | 21.34 | .819 | .840 |
| E | 15.75 | 16.13 | .620 | .635 |
| e | 5.45 BSC | | .215 BSC | |
| L | 19.81 | 20.32 | .780 | .800 |
| L1 | 3.81 | 4.32 | .150 | .170 |
| Q | 5.59 | 6.20 | .220 | .244 |
| R | 4.32 | 4.83 | .170 | .190 |