

# BGA711L7

Single-Band UMTS LNA  
(2100, 1900 MHz)

RF & Protection Devices



Never stop thinking

**Edition 2009-05-27**

**Published by  
Infineon Technologies AG  
81726 München, Germany**

**© Infineon Technologies AG 2009.  
All Rights Reserved.**

### **Legal Disclaimer**

The information given in this document shall in no event be regarded as a guarantee of conditions or characteristics ("Beschaffenhheitsgarantie"). With respect to any examples or hints given herein, any typical values stated herein and/or any information regarding the application of the device, Infineon Technologies hereby disclaims any and all warranties and liabilities of any kind, including without limitation warranties of non-infringement of intellectual property rights of any third party.

### **Information**

For further information on technology, delivery terms and conditions and prices please contact your nearest Infineon Technologies Office ([www.infineon.com](http://www.infineon.com)).

### **Warnings**

Due to technical requirements components may contain dangerous substances. For information on the types in question please contact your nearest Infineon Technologies Office.

Infineon Technologies Components may only be used in life-support devices or systems with the express written approval of Infineon Technologies, if a failure of such components can reasonably be expected to cause the failure of that life-support device or system, or to affect the safety or effectiveness of that device or system. Life support devices or systems are intended to be implanted in the human body, or to support and/or maintain and sustain and/or protect human life. If they fail, it is reasonable to assume that the health of the user or other persons may be endangered.

---

**BGA711L7**

**Revision History: 2009-05-27, V3.2**

**Previous Version: 2008-11-05, V3.1**

<b>Page</b>	<b>Subjects (major changes since last revision)</b>
7	Updated DC Characteristics (added limits)
9, 10, 11	Updated footnotes
18	Updated value of C4 at Application Circuit Schematic for band II

## Table of Contents

	<b>Table of Contents</b> .....	4
<b>1</b>	<b>Description</b> .....	5
<b>2</b>	<b>Electrical Characteristics</b> .....	6
2.1	Absolute Maximum Ratings .....	6
2.2	Thermal Resistance .....	6
2.3	ESD Integrity .....	6
2.4	DC Characteristics .....	7
2.5	Gain Mode Select Truth Table .....	7
2.6	Switching Times .....	7
2.7	Supply current and Power gain characteristics; $T_A = 25\text{ }^\circ\text{C}$ .....	8
2.8	Logic Signal Characteristics; $T_A = 25\text{ }^\circ\text{C}$ .....	8
2.9	Measured RF Characteristics UMTS Bands I / IV / X (with reference resistor) .....	9
2.10	Measured RF Characteristics UMTS Bands I / IV / X (without reference resistor) .....	10
2.11	Measured RF Characteristics UMTS Band II (with reference resistor) .....	11
2.12	Measured Performance High Band (Band I) High Gain Mode vs. Frequency .....	12
2.13	Measured Performance High Band (Band I) High Gain Mode vs. Temperature .....	13
2.14	Measured Performance High Band (Band I) Low Gain Mode vs. Frequency .....	14
2.15	Measured Performance High Band (Band I) Low Gain Mode vs. Temperature .....	16
<b>3</b>	<b>Application Circuit and Block Diagram</b> .....	17
3.1	UMTS bands I, IV and X Application Circuit Schematic .....	17
3.2	UMTS band II Application Circuit Schematic .....	17
3.3	Pin Definition .....	18
3.4	Application Board .....	19
<b>4</b>	<b>Physical Characteristics</b> .....	21
4.1	Package Dimensions .....	21

## 1 Description

The BGA711L7 is a low current single-band low noise amplifier MMIC for UMTS bands I, IV and X. The LNA is based upon Infineon's proprietary and cost-effective SiGe:C technology and comes in a low profile TSLP-7-1 leadless green package. Because the matching is off chip, the 2100 MHz path can be easily converted into a 1900 MHz path by optimizing the input and output matching network. This document specifies the electrical parameters, pinout, application circuit and packaging of the chip.

### Features

- Gain: 17 / -8 dB in high / low gain mode
- Noise figure: 1.1 dB in high gain mode
- Supply current: 3.6 / 0.5 mA in high / low gain mode
- Standby mode (< 2  $\mu$ A typ.)
- Output internally matched to 50  $\Omega$
- Inputs pre-matched to 50  $\Omega$
- 2 kV HBM ESD protection
- Low external component count
- Small leadless TSLP-7-1 package (2.0 x 1.3 x 0.39 mm)
- Pb-free (RoHS compliant) package



**TSLP-7-1 package**

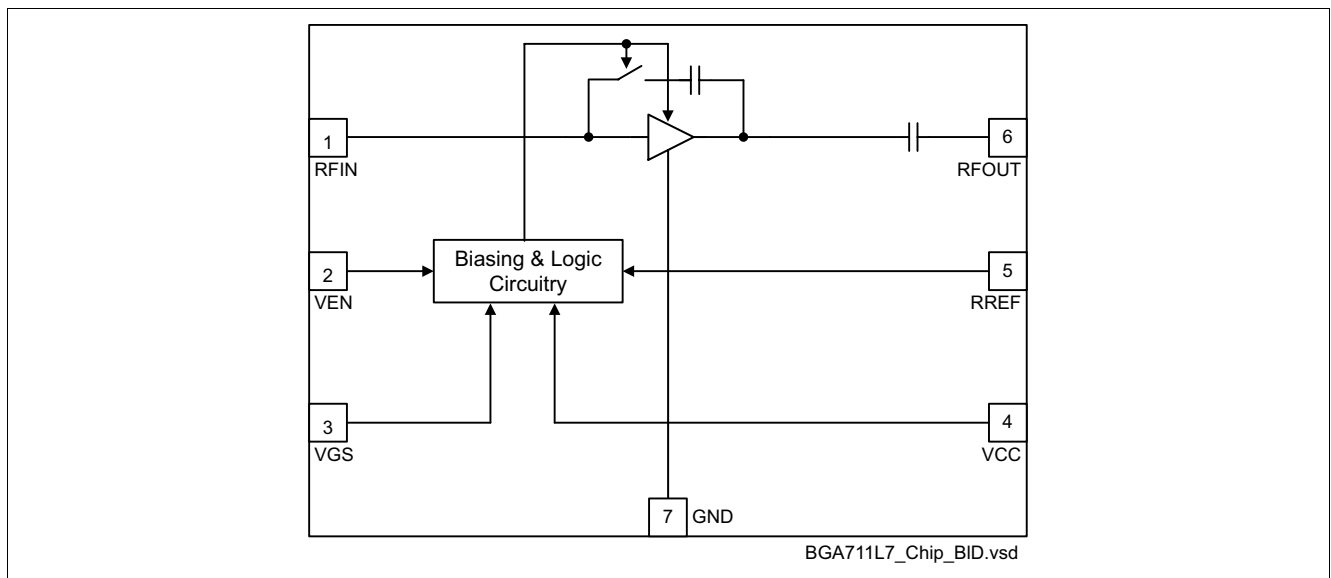

**Figure 1 Block diagram of single-band LNA**

Type	Package	Marking	Chip
BGA711L7	TSLP-7-1	B1	T1531

## 2 Electrical Characteristics

### 2.1 Absolute Maximum Ratings

Table 1 Absolute Maximum Ratings

Parameter	Symbol	Values		Unit	Note / Test Condition
		Min.	Max.		
Supply voltage	$V_{CC}$	-0.3	3.6	V	
Supply current	$I_{CC}$		10	mA	
Pin voltage	$V_{PIN}$	-0.3	$V_{CC}+0.3$	V	All pins except RF input pin
Pin voltage RF Input Pin	$V_{RFIN}$	-0.3	0.9	V	
RF input power	$P_{RFIN}$		4	dBm	
Junction temperature	$T_j$		150	°C	
Ambient temperature range	$T_A$	-30	85	°C	
Storage temperature range	$T_{stg}$	-65	150	°C	

### 2.2 Thermal Resistance

Table 2 Thermal Resistance

Parameter	Symbol	Value	Unit	Note / Test Conditions
Thermal resistance junction to soldering point	$R_{thJS}$	240	K/W	

### 2.3 ESD Integrity

Table 3 ESD Integrity

Parameter	Symbol	Value (typ.)	Unit	Note / Test Conditions
ESD hardness HBM <sup>1)</sup>	$V_{ESD-HBM}$	2000	V	All pins

1) According to JESD22-A114

## 2.4 DC Characteristics

**Table 4 DC Characteristics,  $T_A = 25\text{ °C}$**

Parameter	Symbol	Values			Unit	Note / Test Condition
		Min.	Typ.	Max.		
Supply voltage	$V_{CC}$	2.6	2.8	3.0	V	
Supply current high gain mode	$I_{CCHG}$		3.6		mA	
Supply current low gain mode	$I_{CCLG}$		500		$\mu\text{A}$	
Supply current standby mode	$I_{CCOFF}$		0.1	2.0	$\mu\text{A}$	
Logic level high	$V_{HI}$	1.5	2.8		V	VEN and VGS
Logic level low	$V_{LO}$	-0.2	0.0	0.5	V	
Logic currents VEN	$I_{ENL}$			0.1	$\mu\text{A}$	VEN
	$I_{ENH}$		5.0	6.0	$\mu\text{A}$	
Logic currents VGS	$I_{GSL}$			0.1	$\mu\text{A}$	VGS
	$I_{GSH}$		5.0	6.0	$\mu\text{A}$	

## 2.5 Gain Mode Select Truth Table

**Table 5 Truth Table**

Control Voltage		State	
		Bands I, II, IV and X	
VEN	VGS	HG	LG
H	L	OFF	ON
H	H	ON	OFF
L	L	STANDBY <sup>1)</sup>	
L	H		

1) In order to achieve minimum standby current it is encouraged to apply logic low-level at the VGS pin in standby mode although this is not mandatory. Details see section 2.4.

## 2.6 Switching Times

**Table 6 Typical switching times;  $T_A = -30 \dots 85\text{ °C}$**

Parameter	Symbol	Values			Unit	Note / Test Condition
		Min.	Typ.	Max.		
Settling time gainstep	$t_{GS}$		1		$\mu\text{s}$	Switching LG $\leftrightarrow$ HG

Supply current and Power gain characteristics;  $T_A = 25\text{ }^\circ\text{C}$

## 2.7 Supply current and Power gain characteristics; $T_A = 25\text{ }^\circ\text{C}$

Supply current and Power gain high gain mode versus reference resistor  $R_{REF}$  (see [Figure 2 on page 17](#) for reference resistor; low gain mode supply current is independent of reference resistor).

**Supply Current**  $I_{CC} = f(R_{REF})$   
 $V_{CC} = 2.8\text{ V}$

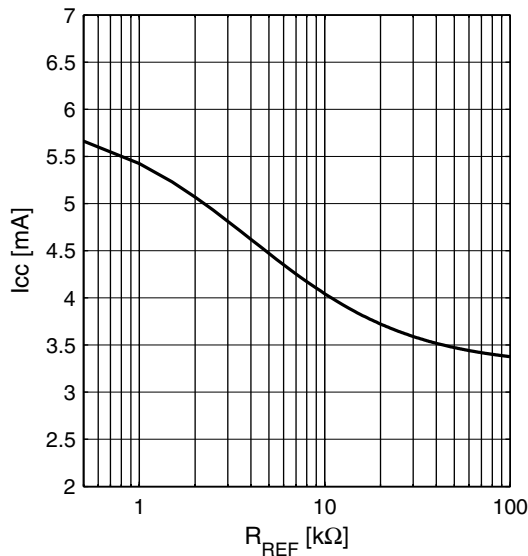

**Power Gain**  $|S_{21}| = f(R_{REF})$   
 $V_{CC} = 2.8\text{ V}$

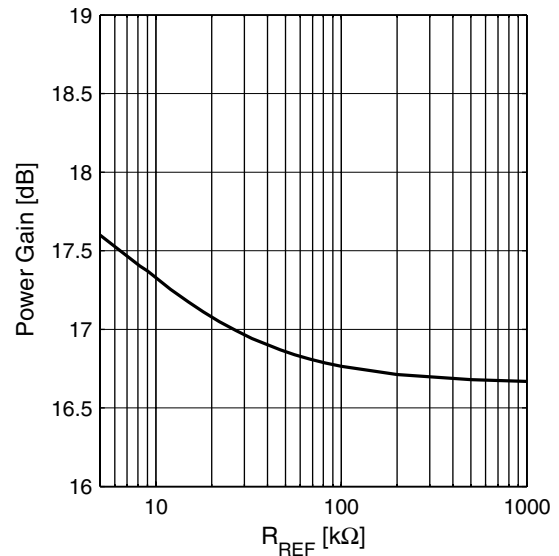

## 2.8 Logic Signal Characteristics; $T_A = 25\text{ }^\circ\text{C}$

Current consumption of logic inputs  $V_{EN}$ ,  $V_{GS}$

**Logic currents**  $I_{EN} = f(V_{EN})$   
 $V_{CC} = 2.8\text{ V}$

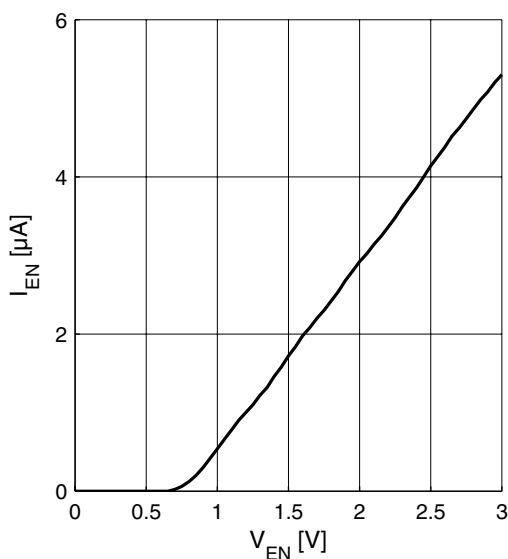

**Logic currents**  $I_{GS} = f(V_{GS})$   
 $V_{CC} = 2.8\text{ V}$

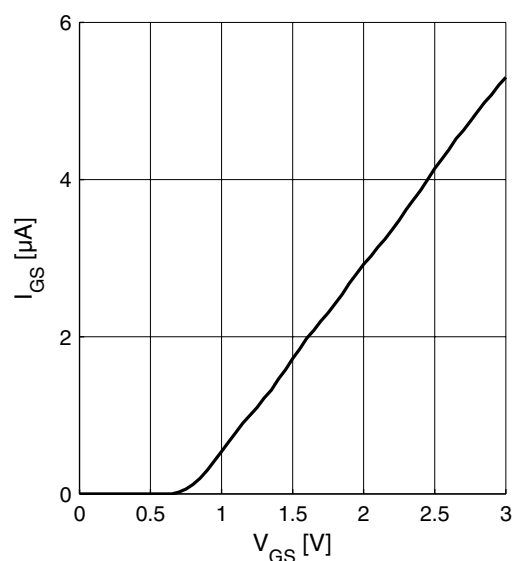



**Measured RF Characteristics UMTS Bands I / IV / X (with reference resistor)**

**2.9 Measured RF Characteristics UMTS Bands I / IV / X (with reference resistor)**

**Table 7 Typical Characteristics 2100 MHz Band  $T_A = 25\text{ °C}$ ,  $V_{CC} = 2.8\text{ V}$ ,  $R_{REF} = 27\text{ k}\Omega$**

Parameter	Symbol	Values			Unit	Note / Test Condition
		Min.	Typ.	Max.		
Pass band range band I / X		2110		2170	MHz	
Pass band range band IV		2110		2155	MHz	
Current consumption	$I_{CCHG}$		3.6		mA	High gain mode
	$I_{CCLG}$		0.5		mA	Low gain mode
Gain	$S_{21HG}$		17.0		dB	High gain mode
	$S_{21LG}$		-7.6		dB	Low gain mode
Reverse Isolation <sup>1)</sup>	$S_{12HG}$		-36		dB	High gain mode
	$S_{12LG}$		-8		dB	Low gain mode
Noise figure	$NF_{HG}$		1.1		dB	High gain mode
	$NF_{LG}$		7.8		dB	Low gain mode
Input return loss <sup>1)</sup>	$S_{11HG}$		-20		dB	50 $\Omega$ , high gain mode
	$S_{11LG}$		-15		dB	50 $\Omega$ , low gain mode
Output return loss <sup>1)</sup>	$S_{22HG}$		-19		dB	50 $\Omega$ , high gain mode
	$S_{22LG}$		-17		dB	50 $\Omega$ , low gain mode
Stability factor <sup>2)</sup>	$k$		>2.3			DC to 10 GHz; all gain modes
Input compression point <sup>1)</sup>	$IP_{1dBHG}$		-8		dBm	High gain mode
	$IP_{1dBLG}$		-2		dBm	Low gain mode
Inband IIP3 <sup>1)</sup> $f_1 - f_2 = 1\text{ MHz}$ $P_{f1} = P_{f2} = -37\text{ dBm}$	$IIP3_{HG}$		-2		dBm	High gain mode
	$IIP3_{LG}$		7			Low gain mode

1) Verification based on AQL; not 100% tested in production

2) Guaranteed by device design; not tested in production

**Measured RF Characteristics UMTS Bands I / IV / X (without ref. resistor)**

**2.10 Measured RF Characteristics UMTS Bands I / IV / X (without ref. resistor)**

**Table 8 Typical Characteristics 2100 MHz Band  $T_A = 25\text{ °C}$ ,  $V_{CC} = 2.8\text{ V}$ ,  $R_{REF} = n/c$**

Parameter	Symbol	Values			Unit	Note / Test Condition
		Min.	Typ.	Max.		
Pass band range band I / X		2110		2170	MHz	
Pass band range band IV		2110		2155	MHz	
Current consumption	$I_{CCHG}$		3.3		mA	High gain mode
	$I_{CCLG}$		0.5		mA	Low gain mode
Gain	$S_{21HG}$		16.7		dB	High gain mode
	$S_{21LG}$		-7.7		dB	Low gain mode
Reverse Isolation <sup>1)</sup>	$S_{12HG}$		-36		dB	High gain mode
	$S_{12LG}$		-8		dB	Low gain mode
Noise figure	$NF_{HG}$		1.1		dB	High gain mode
	$NF_{LG}$		8.1		dB	Low gain mode
Input return loss <sup>1)</sup>	$S_{11HG}$		-21		dB	50 $\Omega$ , high gain mode
	$S_{11LG}$		-14		dB	50 $\Omega$ , low gain mode
Output return loss <sup>1)</sup>	$S_{22HG}$		-19		dB	50 $\Omega$ , high gain mode
	$S_{22LG}$		-18		dB	50 $\Omega$ , low gain mode
Stability factor <sup>2)</sup>	$k$		>2.3			DC to 10 GHz; all gain modes
Input compression point <sup>1)</sup>	$IP_{1dBHG}$		-8		dBm	High gain mode
	$IP_{1dB LG}$		-2		dBm	Low gain mode
Inband IIP3 <sup>1)</sup> $f_1 - f_2 = 1\text{ MHz}$ $P_{f1} = P_{f2} = -37\text{ dBm}$	$IIP3_{HG}$		-2		dBm	High gain mode
	$IIP3_{LG}$		7			Low gain mode

1) Verification based on AQL; not 100% tested in production

2) Guaranteed by device design; not tested in production

**Measured RF Characteristics UMTS Band II (with reference resistor)**

**2.11 Measured RF Characteristics UMTS Band II (with reference resistor)**

**Table 9 Typical Characteristics 1900 MHz Band  $T_A = 25\text{ °C}$ ,  $V_{CC} = 2.8\text{ V}$ ,  $R_{REF} = 27\text{ k}\Omega$**

Parameter	Symbol	Values			Unit	Note / Test Condition
		Min.	Typ.	Max.		
Pass band range band II		1930		1990	MHz	
Current consumption	$I_{CCHG}$		3.6		mA	High gain mode
	$I_{CCLG}$		0.5		mA	Low gain mode
Gain	$S_{21HG}$		17.2		dB	High gain mode
	$S_{21LG}$		-9.2		dB	Low gain mode
Reverse Isolation <sup>1)</sup>	$S_{12HG}$		-38.6		dB	High gain mode
	$S_{12LG}$		-9.2		dB	Low gain mode
Noise figure	$NF_{HG}$		1.1		dB	High gain mode
	$NF_{LG}$		9.4		dB	Low gain mode
Input return loss <sup>1)</sup>	$S_{11HG}$		-14		dB	50 $\Omega$ , high gain mode
	$S_{11LG}$		-15		dB	50 $\Omega$ , low gain mode
Output return loss <sup>1)</sup>	$S_{22HG}$		-15		dB	50 $\Omega$ , high gain mode
	$S_{22LG}$		-18		dB	50 $\Omega$ , low gain mode
Stability factor <sup>2)</sup>	$k$		>2.2			DC to 10 GHz; all gain modes
Input compression point <sup>1)</sup>	$IP_{1dBHG}$		-7		dBm	High gain mode
	$IP_{1dB LG}$		-3		dBm	Low gain mode
Inband IIP3 <sup>1)</sup> $f_1 - f_2 = 1\text{ MHz}$ $P_{f1} = P_{f2} = -37\text{ dBm}$	$IIP3_{HG}$		-3		dBm	High gain mode
	$IIP3_{LG}$		2			Low gain mode

1) Verification based on AQL; not 100% tested in production

2) Guaranteed by device design; not tested in production

**Measured Performance High Band (Band I) High Gain Mode vs. Frequency**

**2.12 Measured Performance High Band (Band I) High Gain Mode vs. Frequency**

$T_A = 25\text{ }^\circ\text{C}$ ,  $V_{CC} = 2.8\text{ V}$ ,  $V_{GS} = 2.8\text{ V}$ ,  $V_{EN} = 2.8\text{ V}$ ,  $R_{REF} = 27\text{ k}\Omega$

**Power Gain  $|S_{21}| = f(f)$**

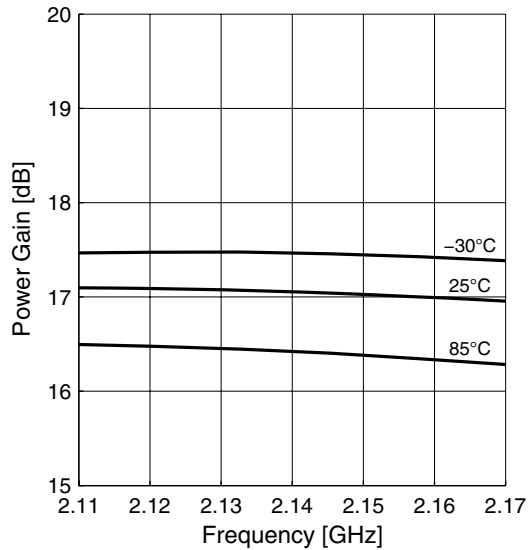

**Power Gain wideband  $|S_{21}| = f(f)$**

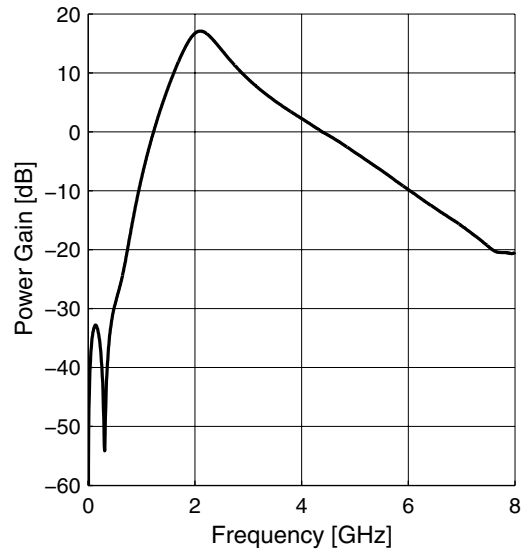

**Matching  $|S_{11}| = f(f)$ ,  $|S_{22}| = f(f)$**

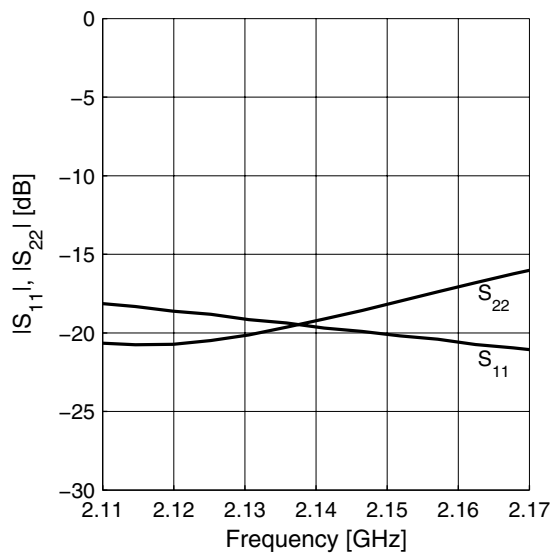

**Gainstep HG-LG  $|\Delta S_{21}| = f(f)$**

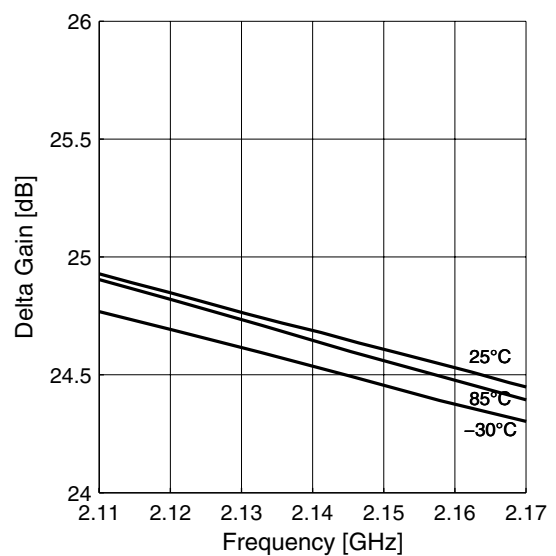

**Measured Performance High Band (Band I) High Gain Mode vs. Temperature**

**Noise Figure  $NF = f(f)$**

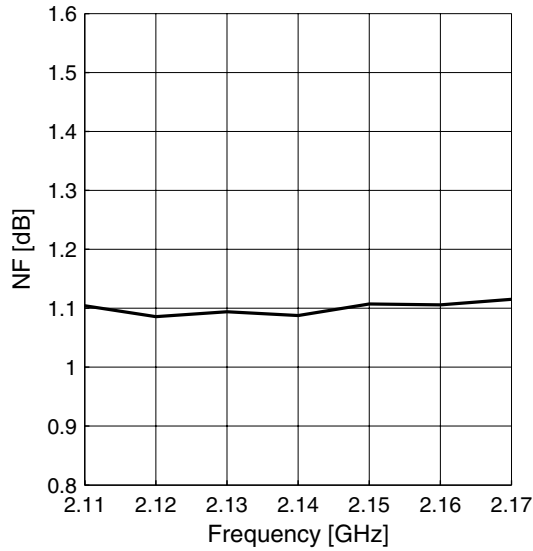

**Input Compression  $P1dB = f(f)$**

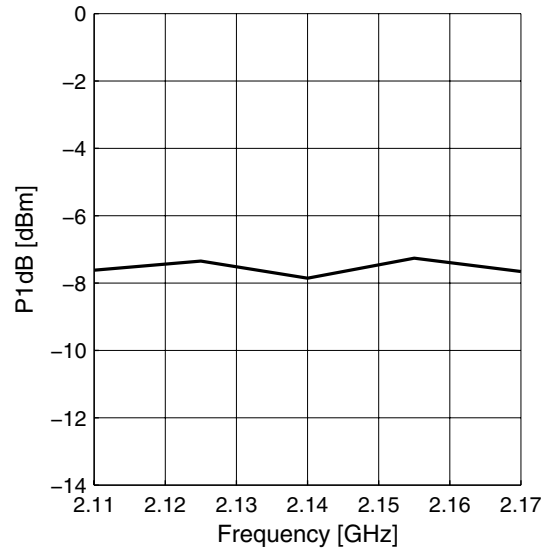

**2.13 Measured Performance High Band (Band I) High Gain Mode vs. Temperature**

$V_{CC} = 2.8 \text{ V}$ ,  $V_{GS} = 2.8 \text{ V}$ ,  $V_{EN} = 2.8 \text{ V}$ ,  $f = 2140 \text{ MHz}$ ,  $R_{REF} = 27 \text{ k}\Omega$

**Power Gain  $|S_{21}| = f(T_A)$**

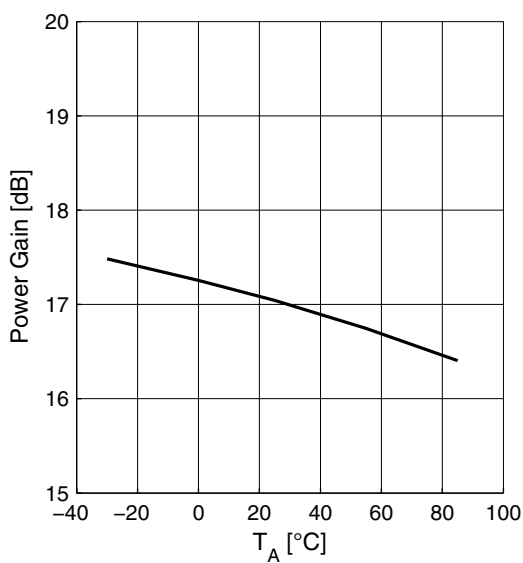

**Supply Current  $I_{CC} = f(T_A)$**

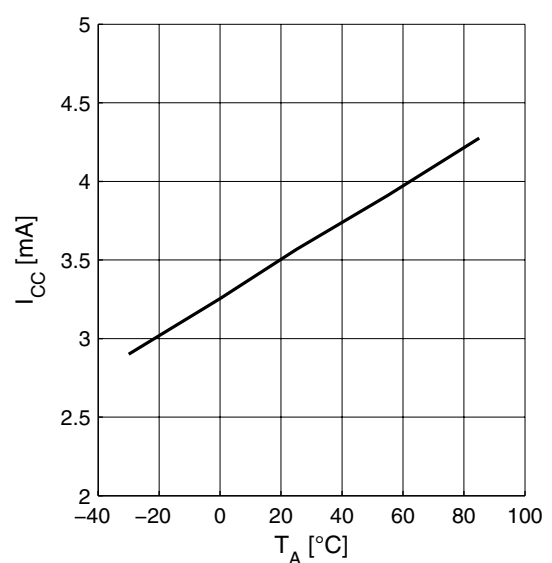

**Measured Performance High Band (Band I) Low Gain Mode vs. Frequency**

**Noise Figure  $NF = f(T_A)$**

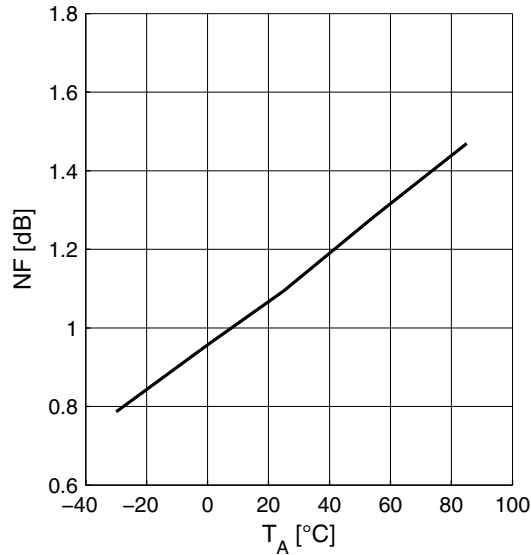

**Input Compression  $P1dB = f(T_A)$**

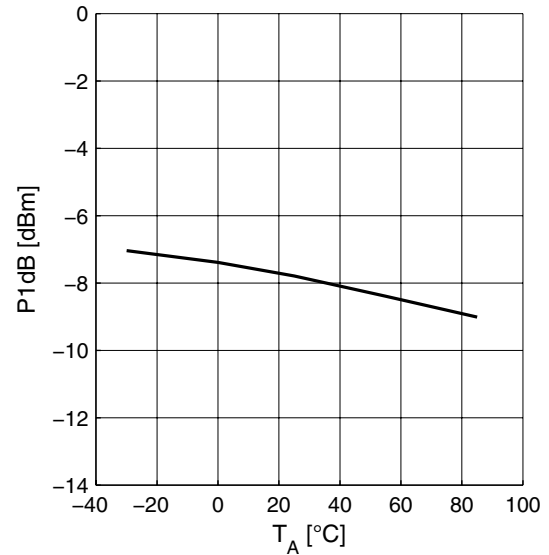

**2.14 Measured Performance High Band (Band I) Low Gain Mode vs. Frequency**

$T_A = 25\text{ °C}$ ,  $V_{CC} = 2.8\text{ V}$ ,  $V_{GS} = 0\text{ V}$ ,  $V_{EN} = 2.8\text{ V}$ ,  $R_{REF} = 27\text{ k}\Omega$

**Power Gain  $|S_{21}| = f(f)$**

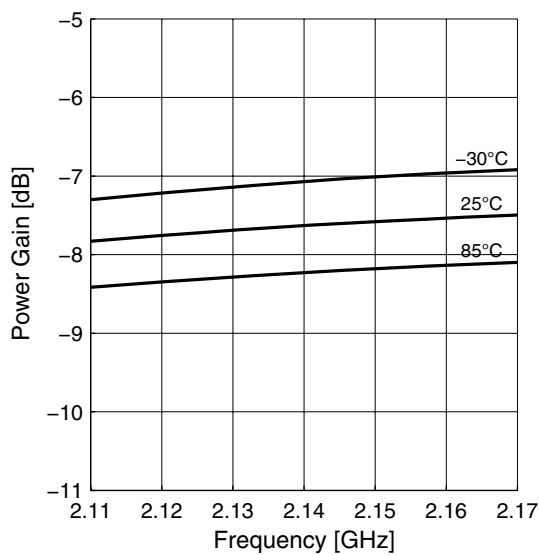

**Power Gain wideband  $|S_{21}| = f(f)$**

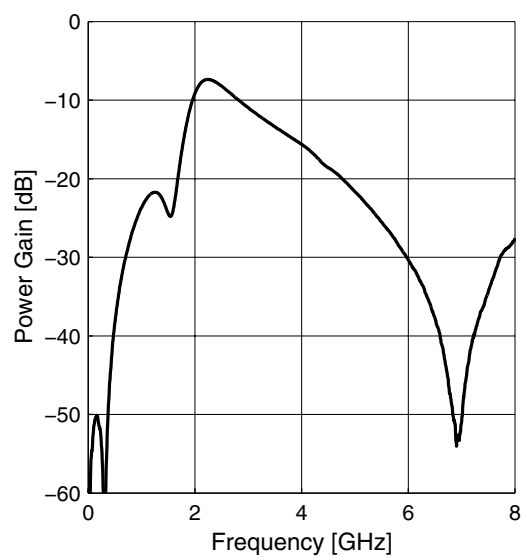

**Measured Performance High Band (Band I) Low Gain Mode vs. Frequency**

**Matching**  $|S_{11}| = f(f)$ ,  $|S_{22}| = f(f)$

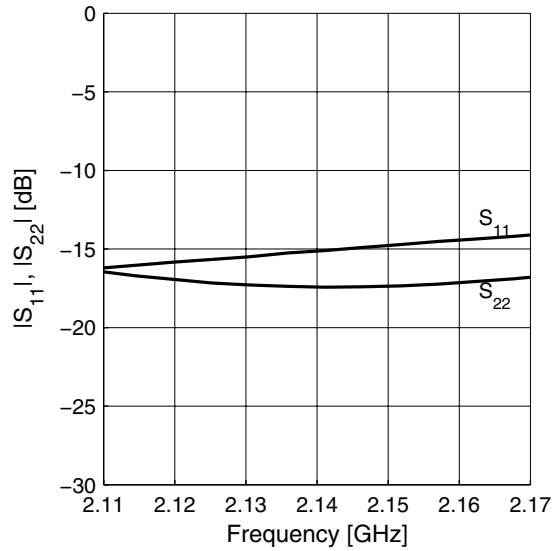

**Noise Figure**  $NF = f(f)$

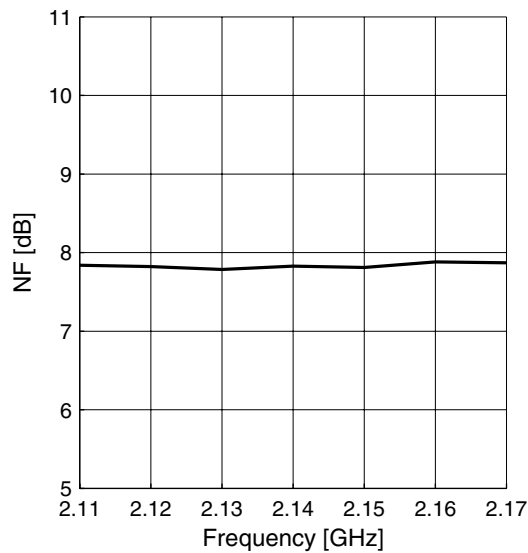

**Input Compression**  $P1dB = f(f)$

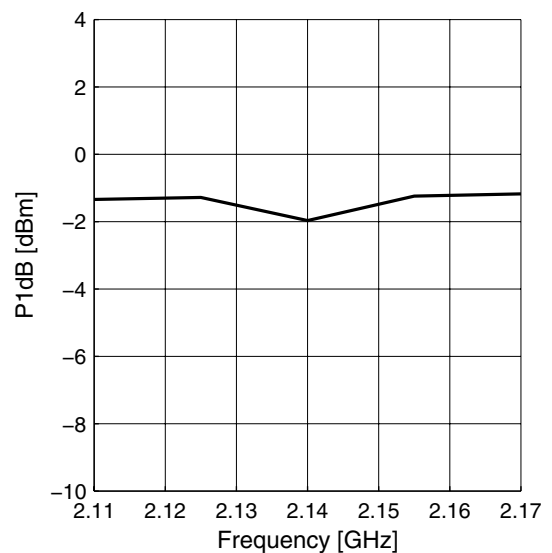

**Measured Performance High Band (Band I) Low Gain Mode vs. Temperature**

**2.15 Measured Performance High Band (Band I) Low Gain Mode vs. Temperature**

$V_{CC} = 2.8\text{ V}$ ,  $V_{GS} = 0\text{ V}$ ,  $V_{EN} = 2.8\text{ V}$ ,  $f = 2140\text{ MHz}$ ,  $R_{REF} = 27\text{ k}\Omega$

**Power Gain  $|S_{21}| = f(T_A)$**

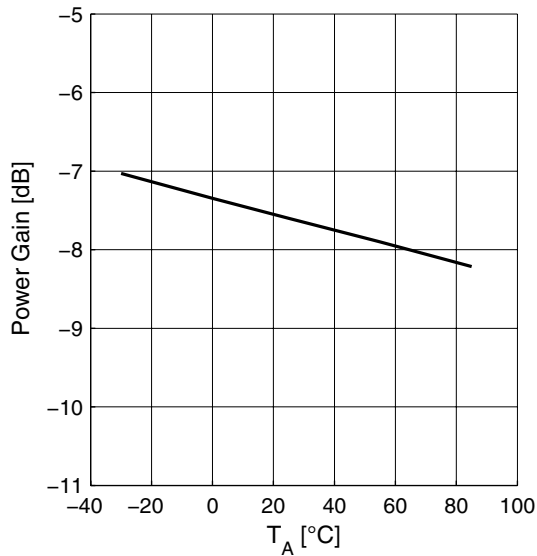

**Supply Current  $I_{CC} = f(T_A)$**

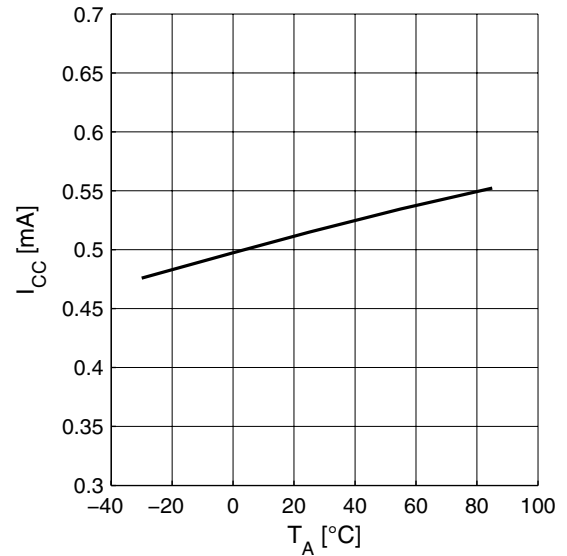

**Noise Figure  $NF = f(T_A)$**

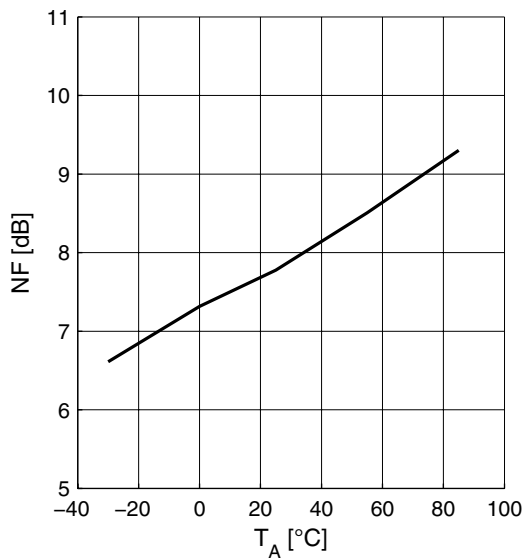

**Input Compression  $P1dB = f(T_A)$**

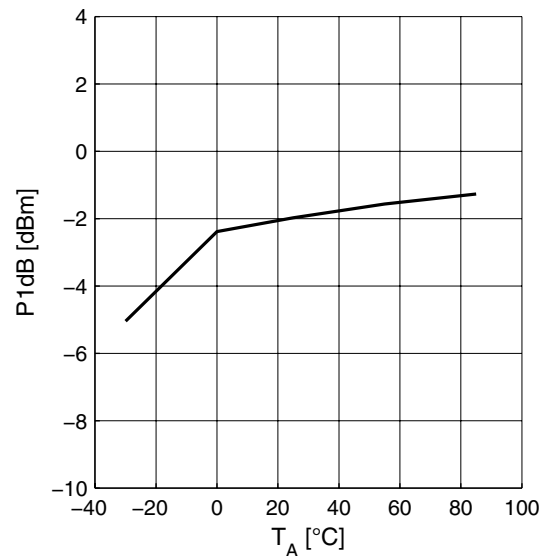



### 3 Application Circuit and Block Diagram

#### 3.1 UMTS bands I, IV and X Application Circuit Schematic

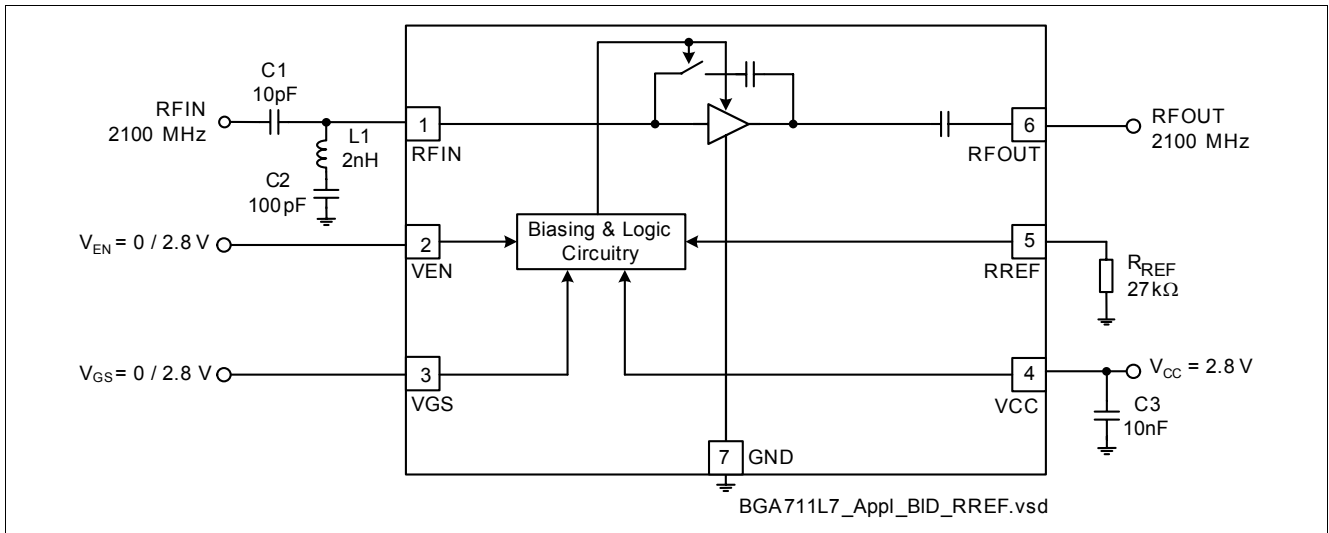

**Figure 2 Application circuit with chip outline (top view)**

*Note: Package paddle (Pin 0) has to be RF grounded.*

**Table 10 Parts List**

Part Number	Part Type	Manufacturer	Size	Comment
L1	Chip inductor	Various	0402	Wirewound, Q ≈ 50
C1 ... C3	Chip capacitor	Various	0402	
R <sub>REF</sub>	Chip resistor	Various	0402	

### 3.2 UMTS band II Application Circuit Schematic

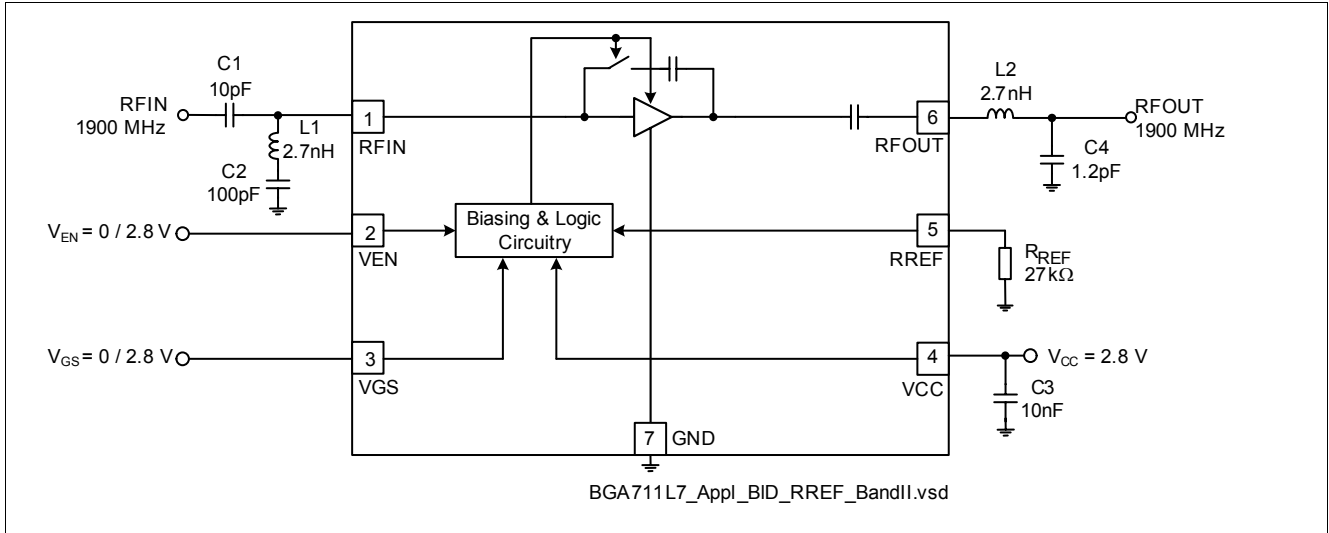

**Figure 3 Application circuit with chip outline (top view)**

*Note: Package paddle (Pin 0) has to be RF grounded.*

**Table 11 Parts List**

Part Number	Part Type	Manufacturer	Size	Comment
L1, L2	Chip inductor	Various	0402	Wirewound, Q ≈ 50
C1 ... C4	Chip capacitor	Various	0402	
R <sub>REF</sub>	Chip resistor	Various	0402	

### 3.3 Pin Definition

**Table 12 Pin Definition and Function**

Pin Number	Symbol	Function
1	RFIN	LNA input (2100/1900 MHz)
2	VEN	Band select control
3	VGS	Gain step control
4	VCC	Supply voltage
5	RREF	Bias current reference resistor (high gain mode)
6	RFOUT	LNA output (2100/1900 MHz)
7	GND	Package paddle; ground connection for LNA and control circuitry

### 3.4 Application Board

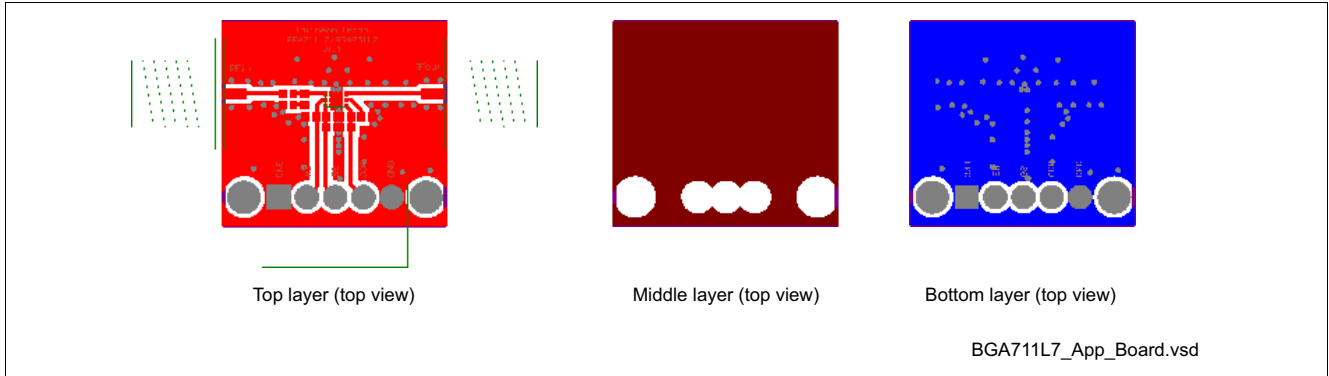

**Figure 4** Application board layout on 3-layer FR4. Top layer thickness: 0.2 mm, bottom layer thickness: 0.8 mm, 17  $\mu\text{m}$  Cu metallization, gold plated. Board size: 21 x 19 mm

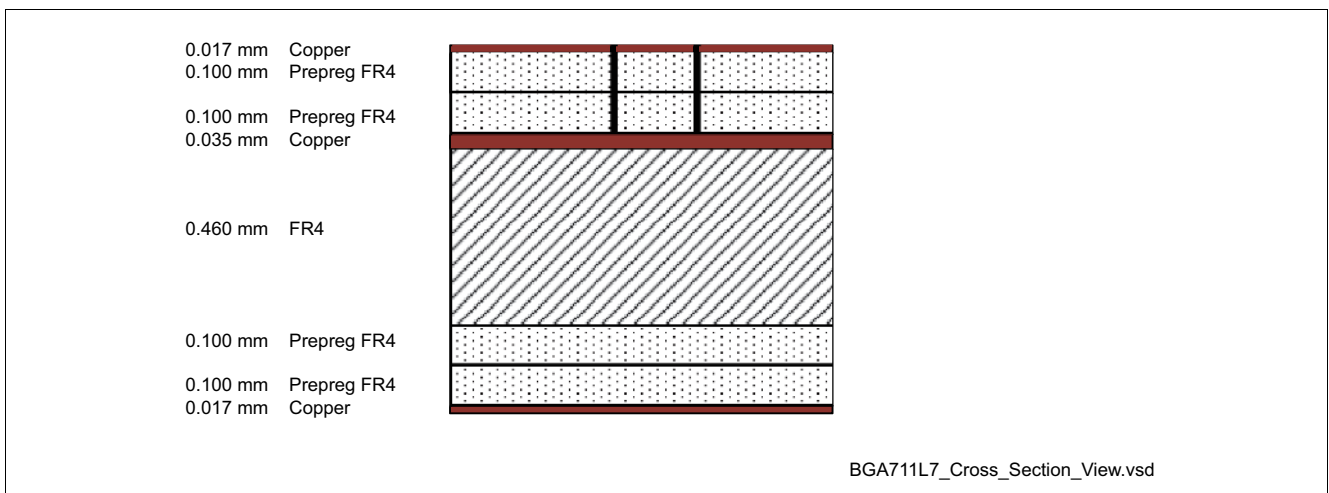

**Figure 5** Cross-section view of application board

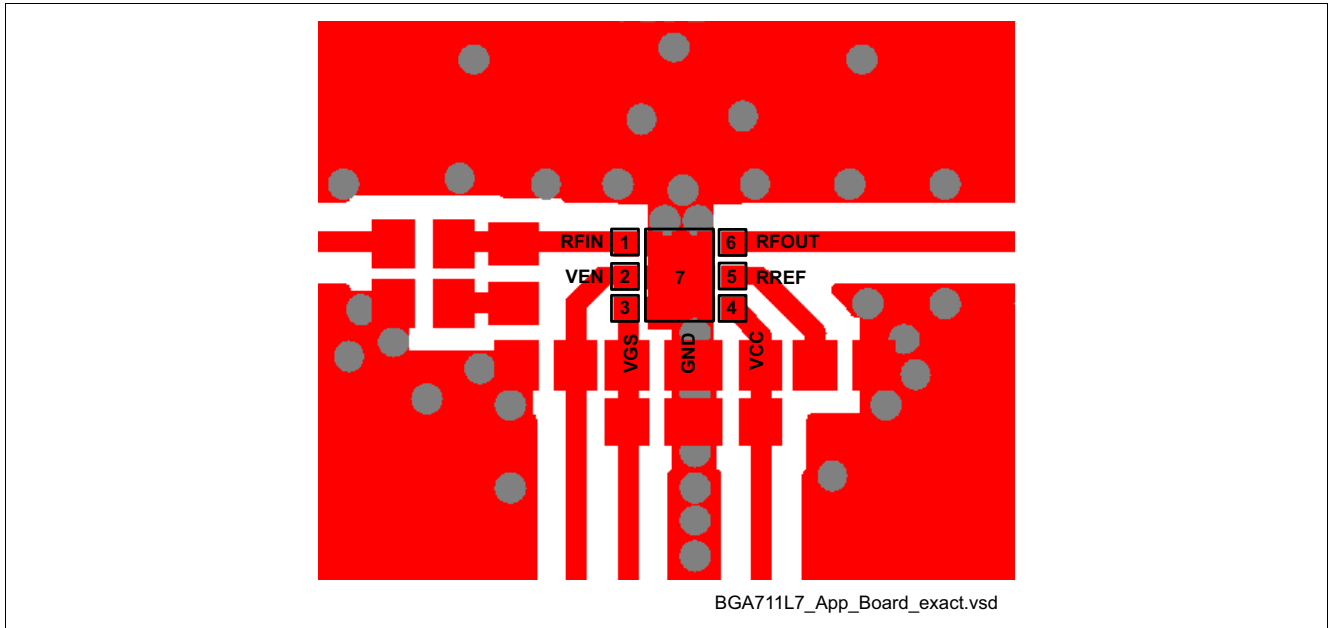
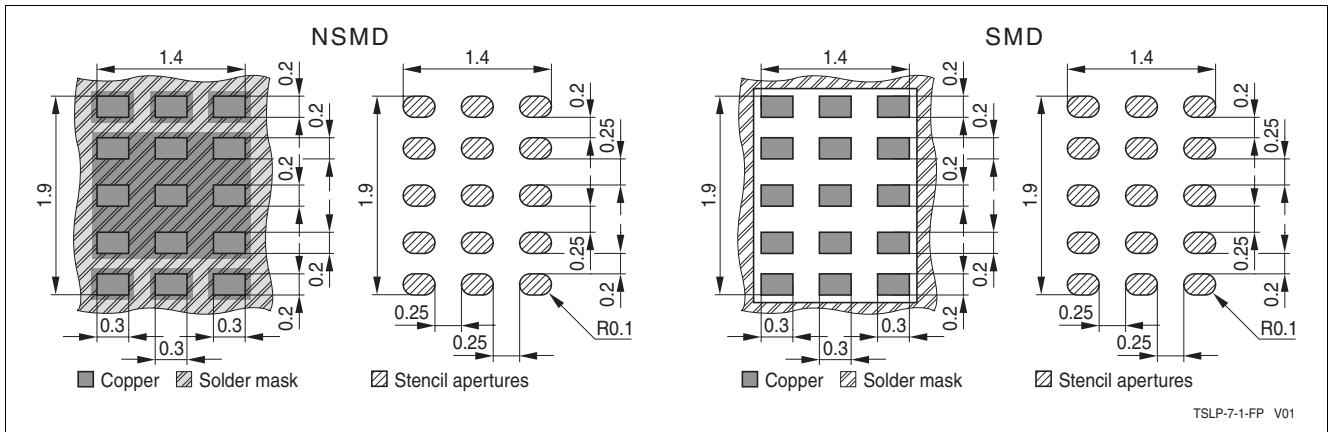

**Figure 6** Detail of application board layout

*Note: In order to achieve the same performance as given in this datasheet please follow the suggested PCB-layout as closely as possible. The position of the GND vias is critical for RF performance.*

## 4 Physical Characteristics

### 4.1 Package Dimensions



**Figure 7 Recommended footprint and stencil layout for the TSLP-7-1 package**

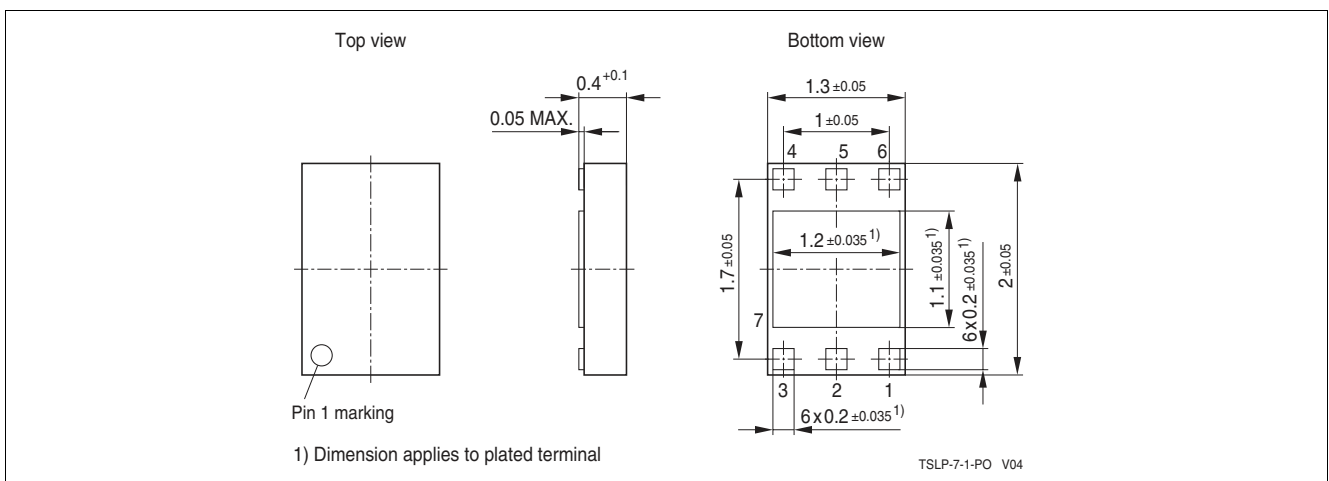

**Figure 8 Package outline (top, side and bottom view)**

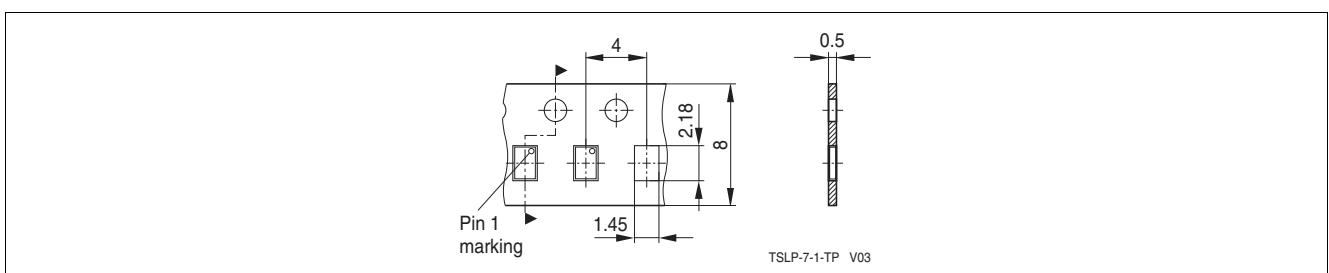

**Figure 9 Tape & Reel Dimensions**

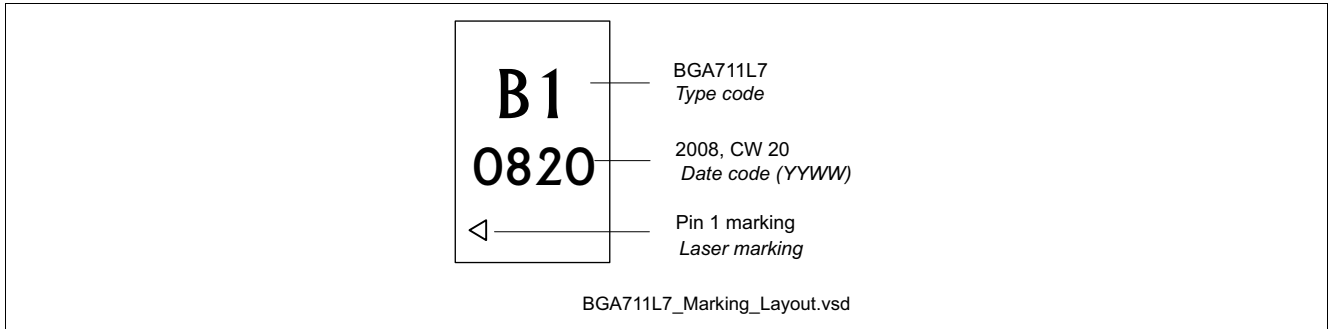

**Figure 10** Marking Layout

[www.infineon.com](http://www.infineon.com)