

## High Dynamic Range Low Noise Amplifier 400 - 500 MHz

Rev. V1

### Features

- Low Noise Figure: 0.9 dB
- High OIP3: +28 dBm at 5 V, 60 mA bias
- High Gain: 21 dB
- Single Supply: +3 to +8 VDC
- Lead-Free SOIC-8 Package
- 100% Matte Tin Plating over Copper
- Halogen-Free “Green” Mold Compound
- 260°C Reflow Compatible
- RoHS\* Compliant Version of MAALSS0025
- Adjustable current: 20 to 80 mA with external resistor

### Description

M/A-COM's MAAL-008624 is a high dynamic range, low noise GaAs MMIC amplifier in a low cost, surface mount package. It employs external input matching to obtain optimum noise figure performance and operating frequency flexibility.

The MAAL-008624 also features flexible biasing to control the current consumption vs. dynamic range trade-off. The MAAL-008624 can operate from any supply voltage in the 3 V to 8 V range. Its current can be controlled over a range of 20 mA to 80 mA with an external resistor.

The MAAL-008624 is ideally suited for use where low noise figure, high gain, high dynamic range, and low power consumption are required. Typical applications include receiver front ends in CDMA450 base stations. It is also useful as a gain block, buffer, driver, and IF amplifier in both fixed and portable cellular and 450 MHz ISM systems.

The MAAL-008624 is fabricated using a low-cost 0.5-micron gate length GaAs process. The process features full passivation for increased performance reliability.

### Ordering Information<sup>1</sup>

Part Number	Package
MAAL-008624-000000	Bulk Packaging
MAAL-008624-TR3000	3000 piece reel

1. Reference Application Note M513 for reel size information.

\* Restrictions on Hazardous Substances, European Union Directive 2002/95/EC.

### Functional Block Diagram

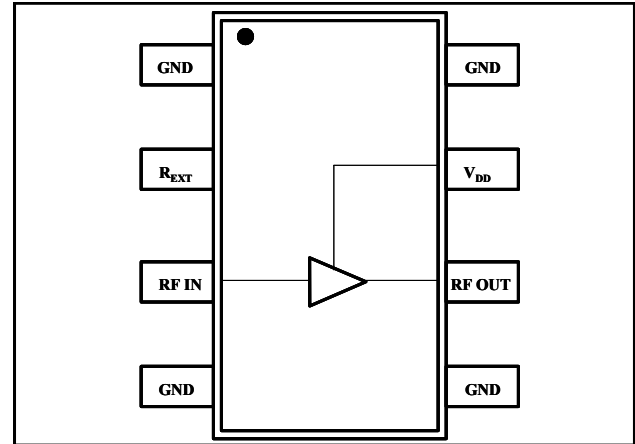

### Pin Configuration

Pin No.	Pin Name	Description
1	GND	RF and DC Ground
2	R <sub>EXT</sub>	External Current Control (optional)
3	RF IN	RF Input
4	GND	RF and DC Ground
5	GND	RF and DC Ground
6	RF OUT	RF Output
7	V <sub>DD</sub>	Positive supply voltage
8	GND	RF and DC Ground

### Absolute Maximum Ratings<sup>2</sup>

Parameter	Absolute Maximum
V <sub>DD</sub>	+10 VDC
Input Power	+10 dBm
Current <sup>3</sup>	120 mA
Channel Temperature <sup>4</sup>	+150°C
Operating Temperature	-40°C to +85°C
Storage Temperature	-65°C to +150°C

2. Exceeding any one or combination of these limits may cause permanent damage to this device.
3. When pin #2 is used to increase current (see note 5).
4. Thermal resistance ( $\theta_{jc}$ ) = +88°C/W.

## High Dynamic Range Low Noise Amplifier 400 - 500 MHz

Rev. V1

**Electrical Specifications:**  $T_A = +25^\circ\text{C}$ ,  $Z_0 = 50 \Omega$ ,  $F = 450 \text{ MHz}$ ,  $P_{in} = -30 \text{ dBm}$

Parameter	Test Conditions	Units	Min	Typ	Max
Gain	5 V, 60 mA <sup>5</sup>	dB	19	21	24
Noise Figure	5 V, 60 mA <sup>5</sup>	dB	—	0.9	1.4
Input Return Loss	—	dB	—	9	—
Output Return Loss	—	dB	—	11	—
Output 1 dB Compression	5 V, 60 mA <sup>5</sup>	dBm	—	16.5	—
Output IP3	5 V, 60 mA <sup>5</sup>	dBm	—	28	—
Input IP3	5 V, 60 mA <sup>5</sup>	dBm	3	7	—
Reverse Isolation	—	dB	—	34	—

5. Using external 15-ohm resistor. See functional schematic.

### Functional Schematic

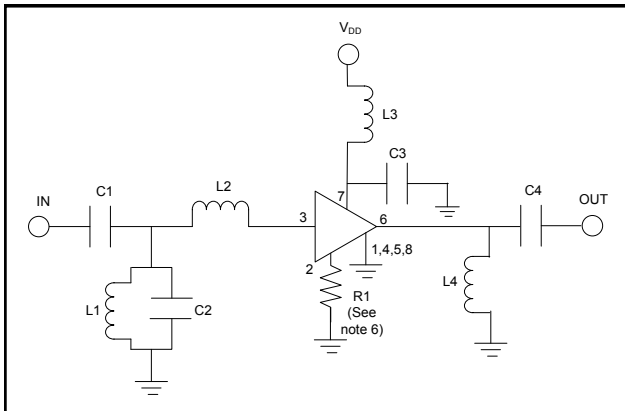

### External Circuitry Parts List

Part	Value	Purpose
C1	100 pF	DC Block
C2	8 pF	Input Matching
C3	470 pF	Bypass
C4	4 pF	Output Matching
L1	22 nH	Input Matching
L2	43 nH	Input Matching
L3	12 nH	RF Choke
L4	11 nH	Output Matching
R1	15 Ohms	Optional current control <sup>6</sup>

### Handling Procedures

The following precautions should be observed to avoid damage:

### Static Sensitivity

Gallium Arsenide Integrated Circuits are sensitive to electrostatic discharge (ESD) and can be damaged by static electricity. Proper ESD control techniques should be used when handling these devices.

6. Pin 2 allows use of an external resistor to ground for optional, higher current. For 20 mA operation, no resistor is used.

For  $I_{DD} \sim 40 \text{ mA}$ ,  $R_2 = 43 \text{ ohms}$ ;  
 For  $I_{DD} \sim 60 \text{ mA}$ ,  $R_2 = 15 \text{ ohms}$ ;  
 For  $I_{DD} \sim 80 \text{ mA}$ ,  $R_2 = 10 \text{ ohms}$ .

## High Dynamic Range Low Noise Amplifier 400 - 500 MHz

Rev. V1

### Typical Performance Curves over Temperature

**Gain**

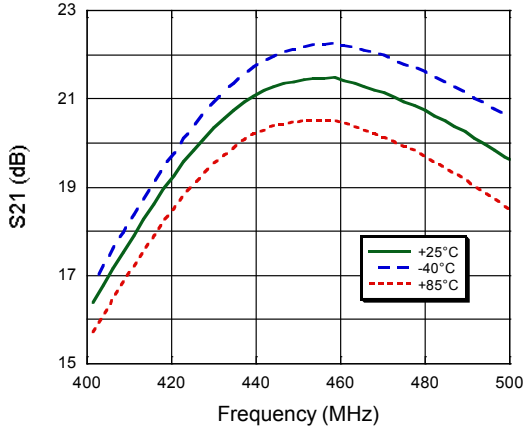

**Reverse Isolation**

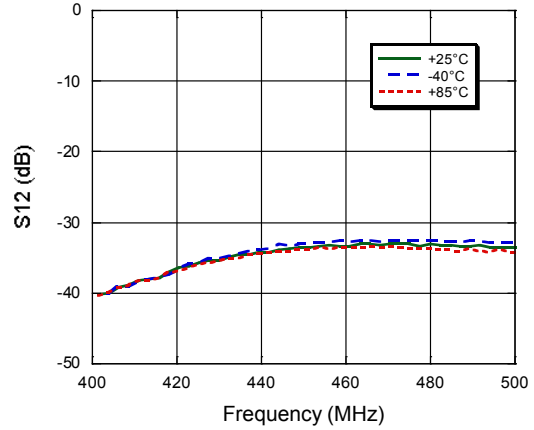

**Input Return Loss**

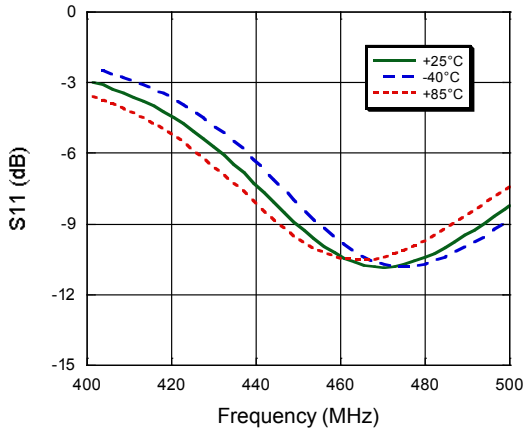

**Output Return Loss**

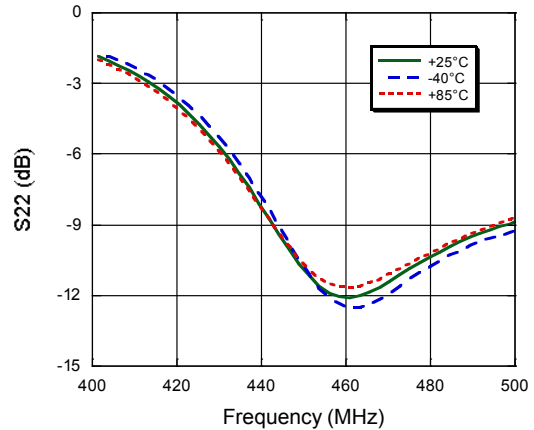

**Noise Figure**

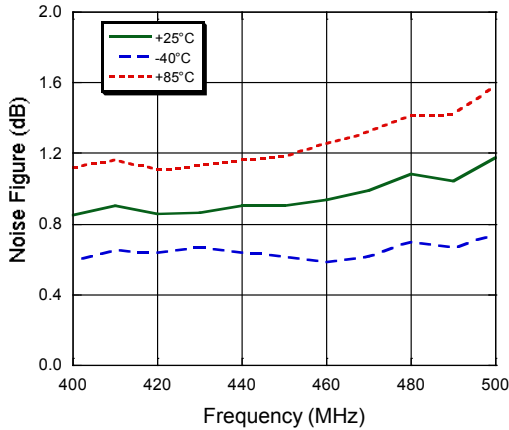

**Output IP3**

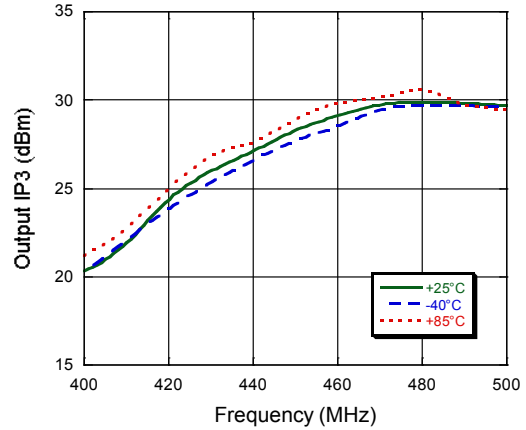

## High Dynamic Range Low Noise Amplifier 400 - 500 MHz

Rev. V1

### Lead-Free SOIC-8<sup>†</sup>

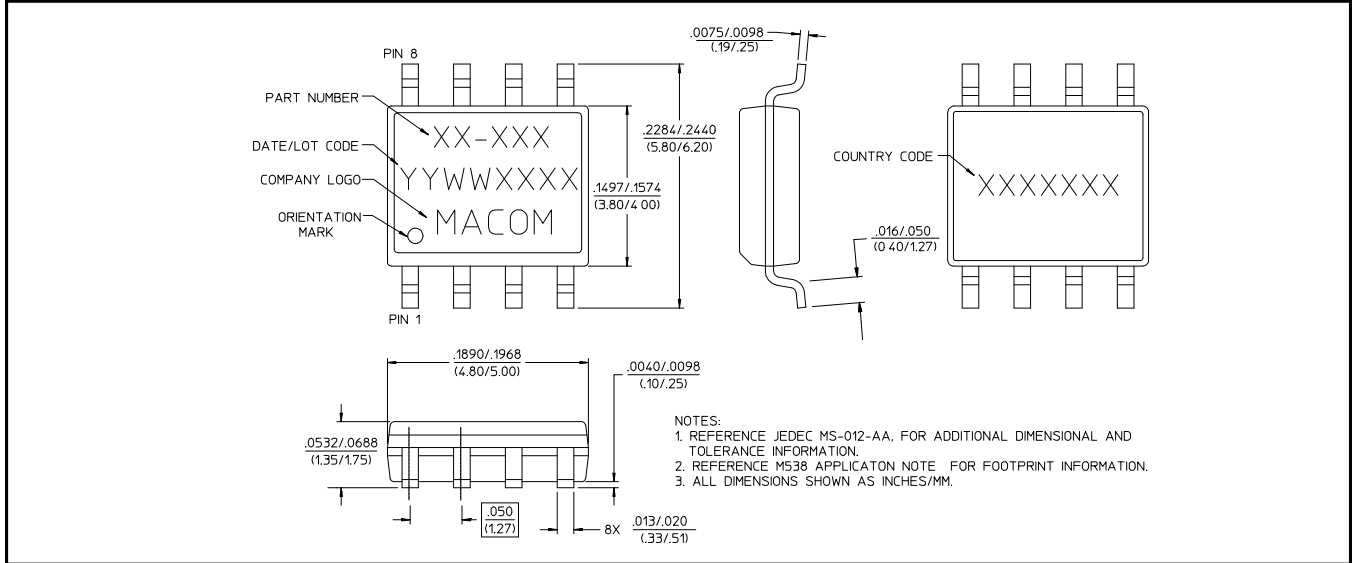

<sup>†</sup> Reference Application Note M538 for lead-free solder reflow recommendations. Meets JEDEC moisture sensitivity level 1 requirements.

### Recommended PCB Configuration

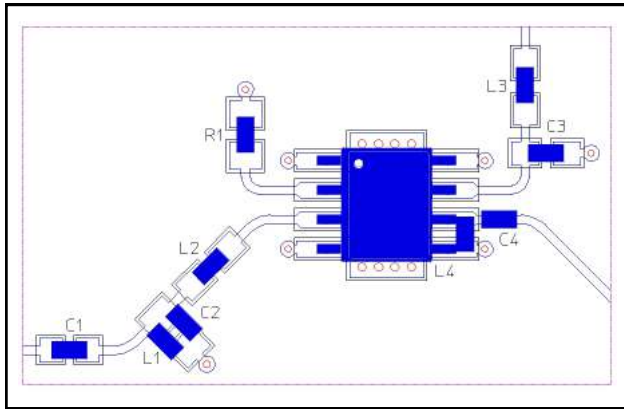

### Cross Section View

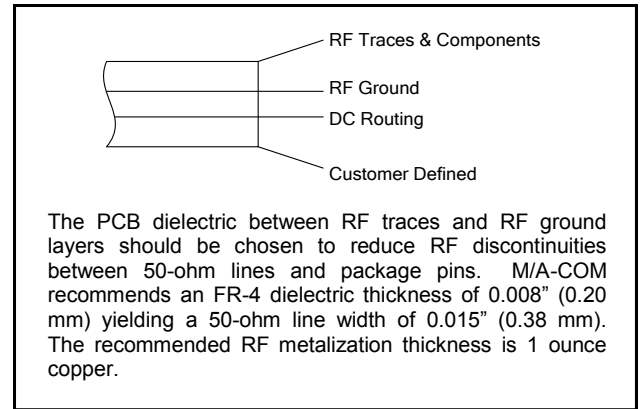

M/A-COM Technology Solutions Inc. All rights reserved.

Information in this document is provided in connection with M/A-COM Technology Solutions Inc ("MACOM") products. These materials are provided by MACOM as a service to its customers and may be used for informational purposes only. Except as provided in MACOM's Terms and Conditions of Sale for such products or in any separate agreement related to this document, MACOM assumes no liability whatsoever. MACOM assumes no responsibility for errors or omissions in these materials. MACOM may make changes to specifications and product descriptions at any time, without notice. MACOM makes no commitment to update the information and shall have no responsibility whatsoever for conflicts or incompatibilities arising from future changes to its specifications and product descriptions. No license, express or implied, by estoppel or otherwise, to any intellectual property rights is granted by this document.

THESE MATERIALS ARE PROVIDED "AS IS" WITHOUT WARRANTY OF ANY KIND, EITHER EXPRESS OR IMPLIED, RELATING TO SALE AND/OR USE OF MACOM PRODUCTS INCLUDING LIABILITY OR WARRANTIES RELATING TO FITNESS FOR A PARTICULAR PURPOSE, CONSEQUENTIAL OR INCIDENTAL DAMAGES, MERCHANTABILITY, OR INFRINGEMENT OF ANY PATENT, COPYRIGHT OR OTHER INTELLECTUAL PROPERTY RIGHT. MACOM FURTHER DOES NOT WARRANT THE ACCURACY OR COMPLETENESS OF THE INFORMATION, TEXT, GRAPHICS OR OTHER ITEMS CONTAINED WITHIN THESE MATERIALS. MACOM SHALL NOT BE LIABLE FOR ANY SPECIAL, INDIRECT, INCIDENTAL, OR CONSEQUENTIAL DAMAGES, INCLUDING WITHOUT LIMITATION, LOST REVENUES OR LOST PROFITS, WHICH MAY RESULT FROM THE USE OF THESE MATERIALS.

MACOM products are not intended for use in medical, lifesaving or life sustaining applications. MACOM customers using or selling MACOM products for use in such applications do so at their own risk and agree to fully indemnify MACOM for any damages resulting from such improper use or sale.