

THIS DRAWING IS UNPUBLISHED. RELEASED FOR PUBLICATION 2000
 © COPYRIGHT 2000 BY TYCO ELECTRONICS CORPORATION. ALL RIGHTS RESERVED.

LOC	DIST	REVISIONS					
P	LTR	DESCRIPTION	DATE	DWN	APVD		
J	-	0	RELEASED	FJ00-1712-00	28AUG2000	T.K	K.I

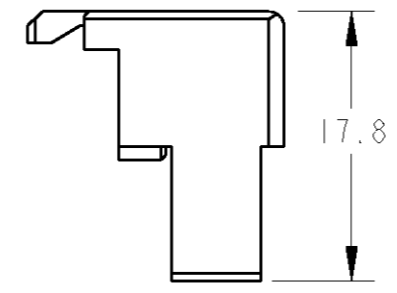
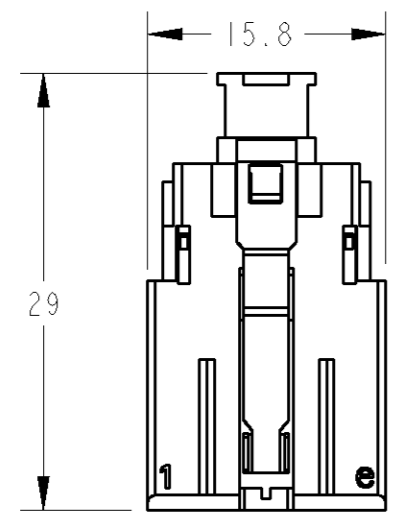
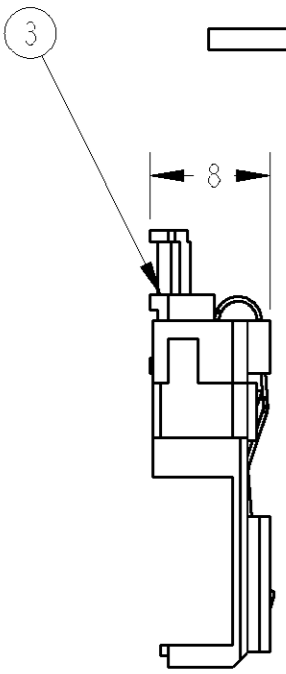
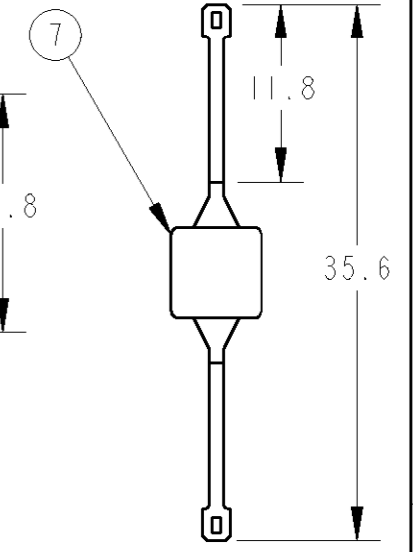
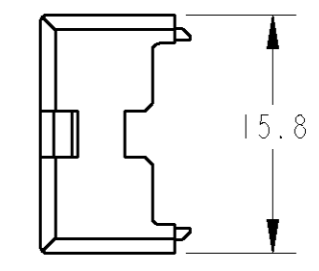
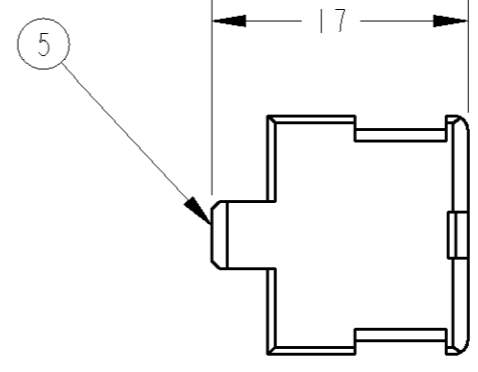
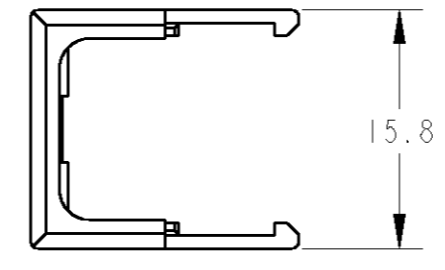
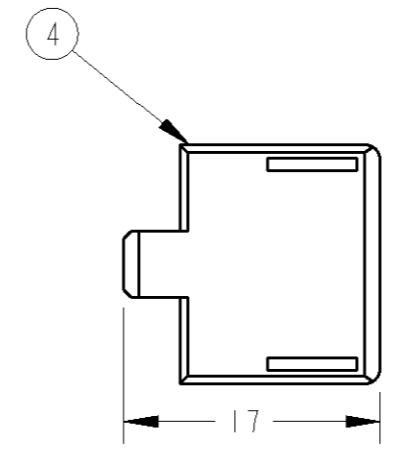
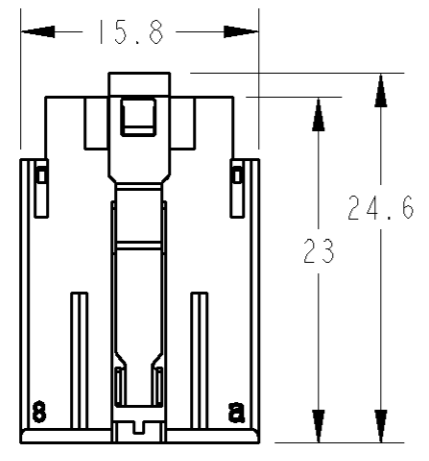
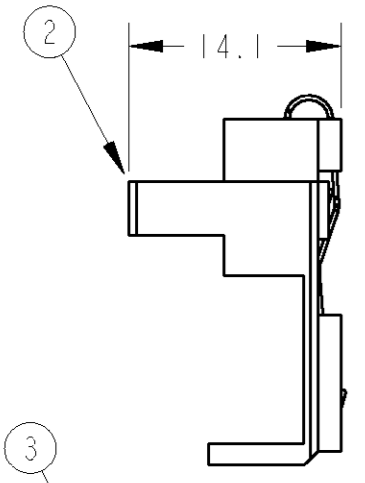
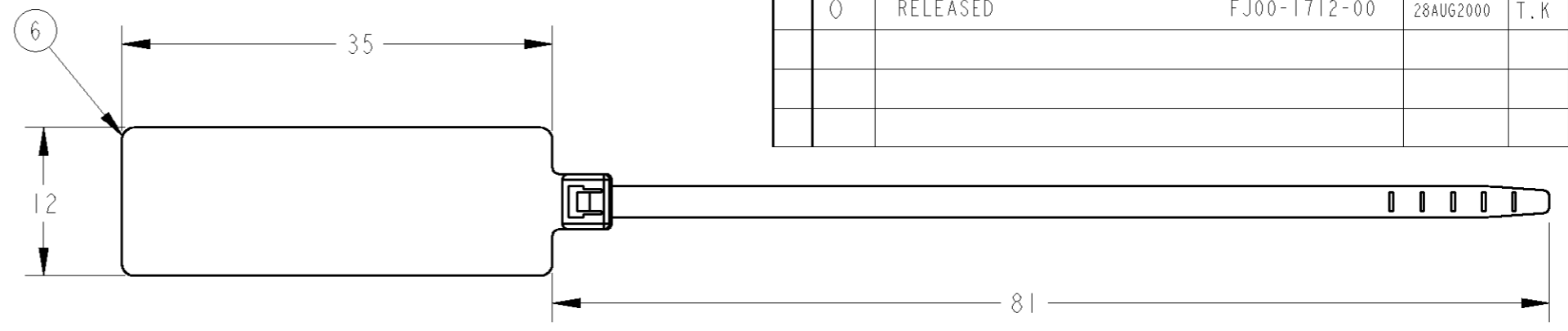
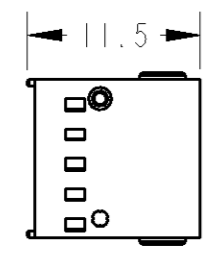
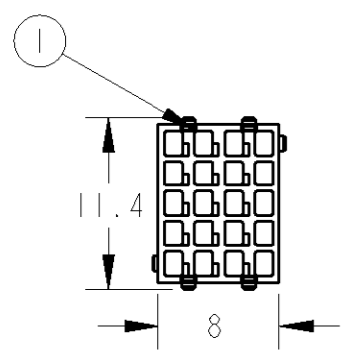

1. 製品は組立てずに梱包される。
 2. 梱包単位: 100EA
 3. 組立時の本体厚; 17.8mm,
 本体高さ (PULL TAB部除<); 30mm
1. PARTS PACKAGED UNASSEMBLED.
 2. PACKING UNIT: 100EA
 3. THICKNESS; 17.8mm
 HEIGHT (EXCEPT FOR THE PULL TAB); 30mm
 (AFTER SET UP)

1	CABLE KEYING	熱可塑性樹脂、ナチュラル/THERMOPLASTIC, NATURAL	7
1	PULL TAB	熱可塑性樹脂、白/THERMOPLASTIC, WHITE	6
1	OUTER COVER BOTTOM 40P	熱可塑性樹脂、黒/THERMOPLASTIC, BLACK	5
1	OUTER COVER TOP 40P	熱可塑性樹脂、黒/THERMOPLASTIC, BLACK	4
1	INNER COVER SUB ASSY BOTTOM 40P	COVER: 熱可塑性樹脂、黒/THERMOPLASTIC, BLACK LOCK LEVER: ステンレス/STAINLESS	3
1	INNER COVER SUB ASSY TOP 40P	COVER: 熱可塑性樹脂、黒/THERMOPLASTIC, BLACK LOCK LEVER: ステンレス/STAINLESS	2
2	RECEPTACLE HOUSING 20P	熱可塑性樹脂、黒/THERMOPLASTIC, BLACK	1
-1	NAME	MATERIAL, COLOR	ITEM

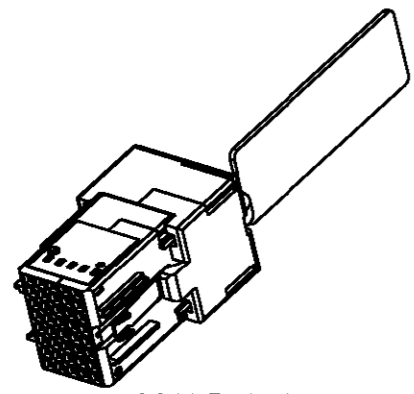

SCALE 1:1

THIS DRAWING IS A CONTROLLED DOCUMENT FOR TYCO ELECTRONICS CORPORATION
 IT IS SUBJECT TO CHANGE AND THE CONTROLLING ENGINEERING ORGANIZATION
 SHOULD BE CONTACTED FOR THE LATEST REVISION.

DIMENSIONS: mm	TOLERANCES UNLESS OTHERWISE SPECIFIED: 0-PLC 10±0.2 1-PLG30±0.25 2-PLG >30±0.3 3-PLC ± 4-PLC ± ANGLES ±3°	DWN T. KATANO 28AUG2000 CHK K. IKEGAMI 28AUG2000 APVD K. IKEGAMI 28AUG2000 PRODUCT SPEC 108-5689 APPLICATION SPEC - WEIGHT 5.95g/EA	AMP Tyco Electronics AMP K.K. Kawasaki, Japan
MATERIAL SEE TABLE	FINISH -	NAME AMP MCC CONN. 40POS.	RESTRICTED TO -
CUSTOMER DRAWING		SIZE A3 CAGE CODE 00779 DRAWING NO. C-1376245	SCALE 2:1 SHEET 1 OF 1 REV 0