

**Contact Code**

503-Fork Tail .115x.025(2.92x0.64) - Tail LG.=.398(10.11)

THIS IS A C.A.D. GENERATED DRAWING  
DO NOT MAKE MANUAL REVISIONS TO MASTER.



ISSUE NUMBER

ORIGINAL ①

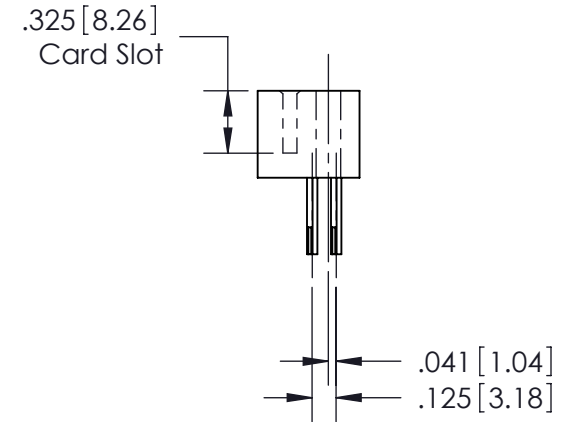
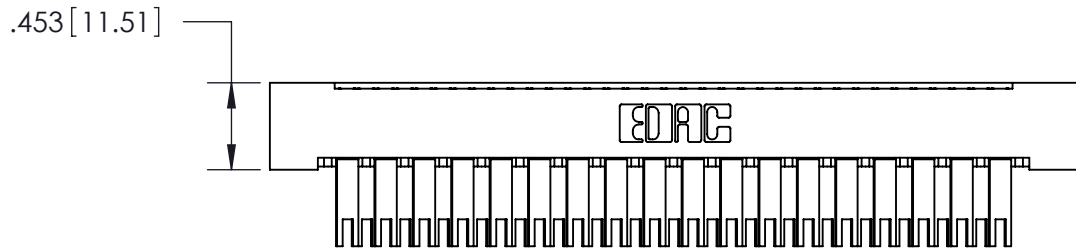
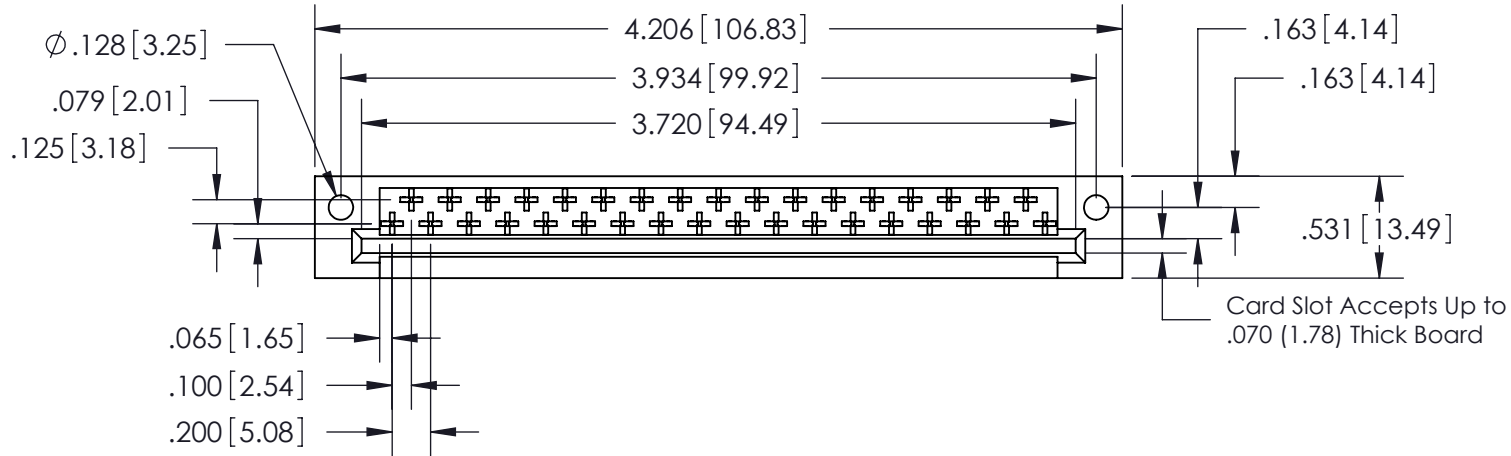

See Accompanying Pages for:  
• Features and Specifications

408/424 Series High Reliability Interlock Connector  
PART NUMBER: 408-035-503-112



EDAC INC  
TORONTO, ONTARIO  
CANADA

YOUR CONNECTION TO QUALITY & SERVICE

THESE DRAWINGS AND SPECIFICATIONS  
ARE THE PROPERTY OF EDAC INC. AND  
SHALL NOT BE REPRODUCED, OR COPIED  
OR USED AS THE BASIS FOR THE  
MANUFACTURE OR SALE OF APPARATUS  
WITHOUT WRITTEN PERMISSION.

ACAD REFERENCE NO. 408-ENG-MASTER

DRAWN: J.LEE DATE: SEPT. 16/09

CHECKED: DATE:

SCALE: NTS SHEET 1 OF 1

DRAWING NUMBER 408-ENG-MASTER ISSUE 1