

PRODUCT NUMBER SEE SHEET 2

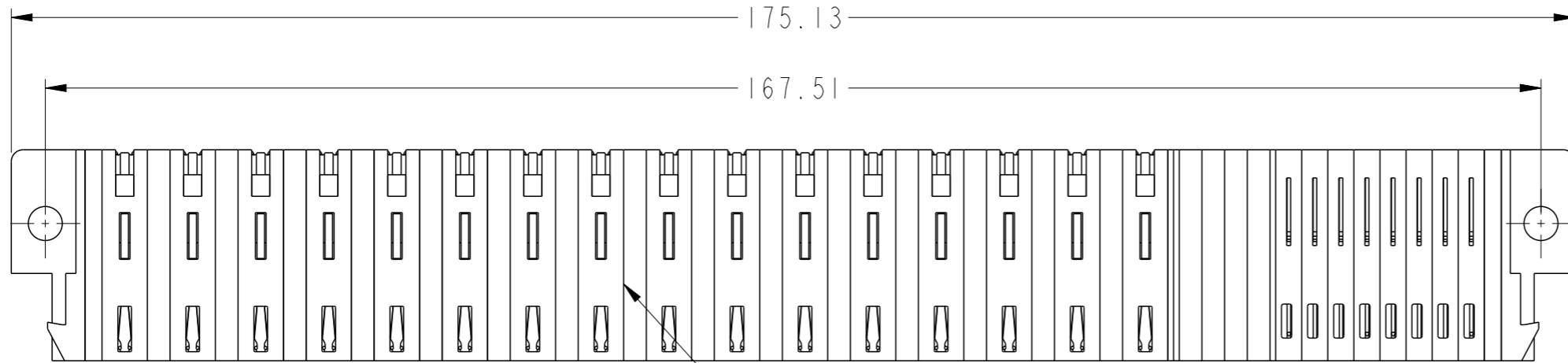

2x3.81 REF

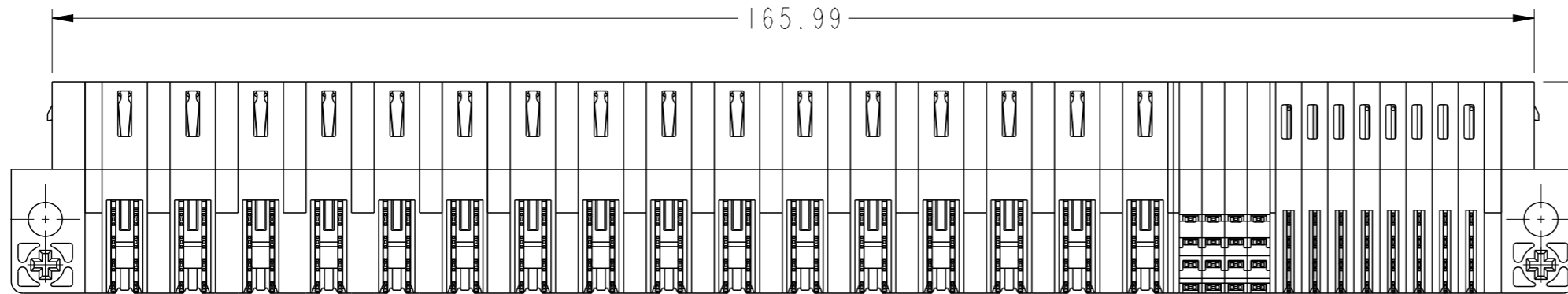
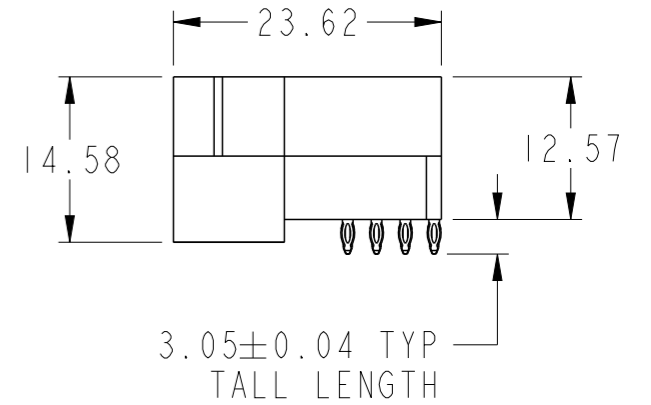
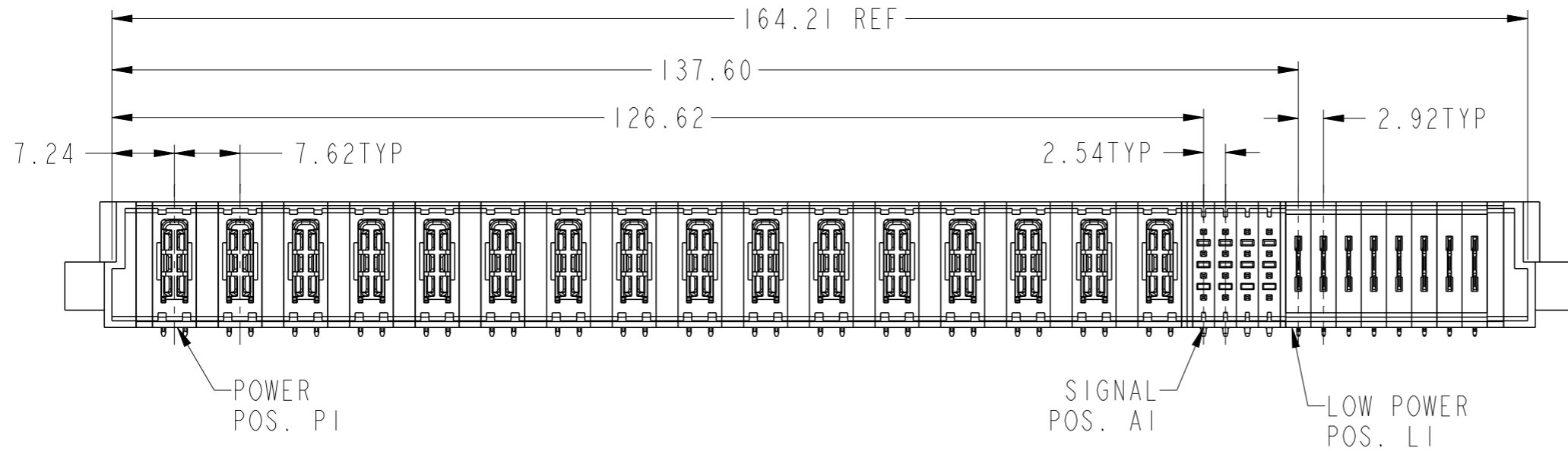

Copyright FCI.
FCI

spec ref	*	dr	Eddy Zeng	2014/12/25	projection	MM	size	A3	scale	3:2													
tolerance std	ASME Y14.5	eng	Vicking Liu	2015/09/22			ecn no	ELX-DG-21958-1															
TOLERANCES UNLESS OTHERWISE SPECIFIED		chr	Fancy Zhang	2015/09/28			product family	PwrBlade+	rel level	Released													
surface	<table border="1"> <tr> <td>linear</td> <td>0.X</td> <td>±0.5</td> </tr> <tr> <td></td> <td>0.XX</td> <td>±0.25</td> </tr> <tr> <td></td> <td>0.XXX</td> <td>±0.10</td> </tr> <tr> <td>angular</td> <td>0°</td> <td>±2°</td> </tr> </table>	linear	0.X	±0.5		0.XX	±0.25		0.XXX	±0.10	angular	0°	±2°	appr	Pei-Ming Zheng	2015/09/28			title	16HP + 16S + 8LP		rev	B
linear	0.X	±0.5																					
	0.XX	±0.25																					
	0.XXX	±0.10																					
angular	0°	±2°																					
ASME Y14.5		www.fci.com	cat. no.	Product - Customer Drw		sheet 1 of 3	dwg no	10106263-G804401															

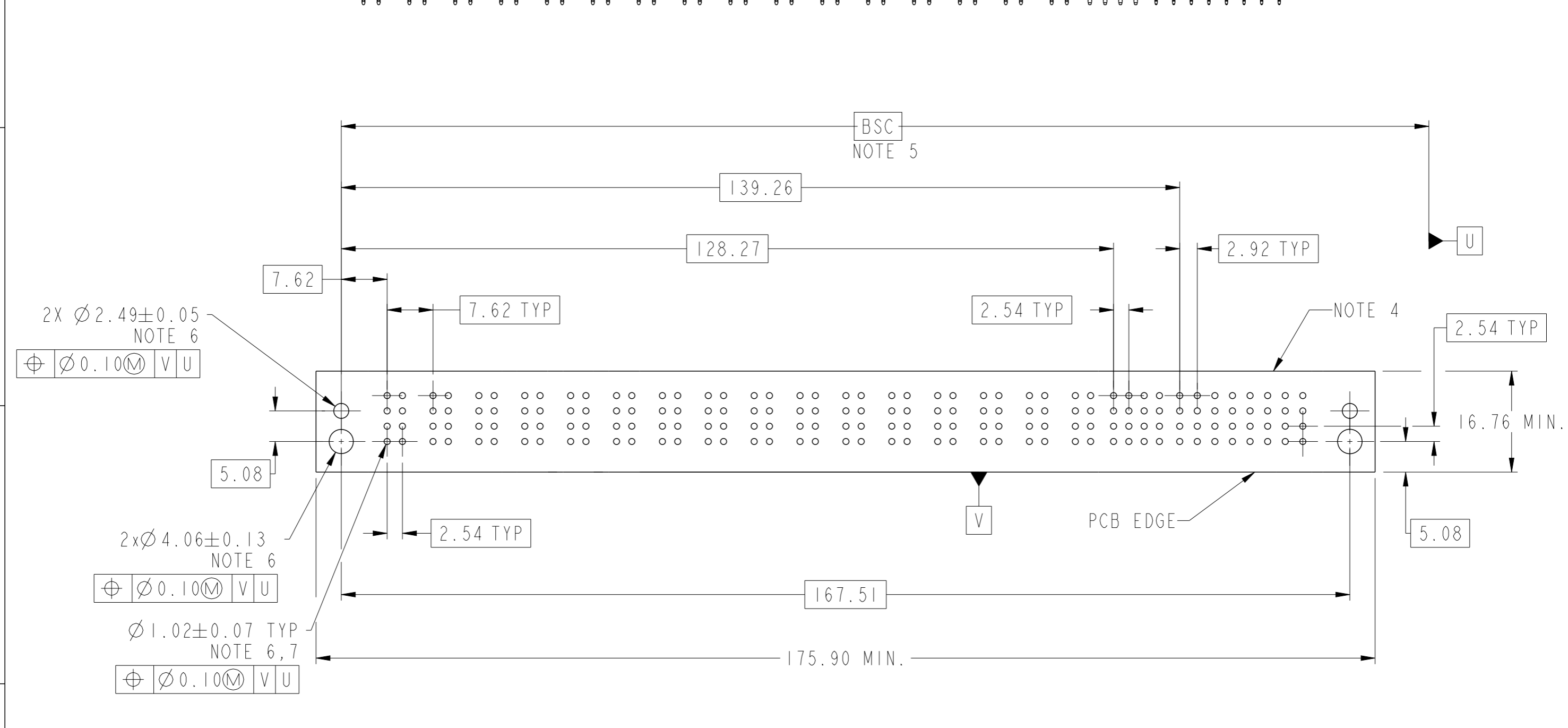
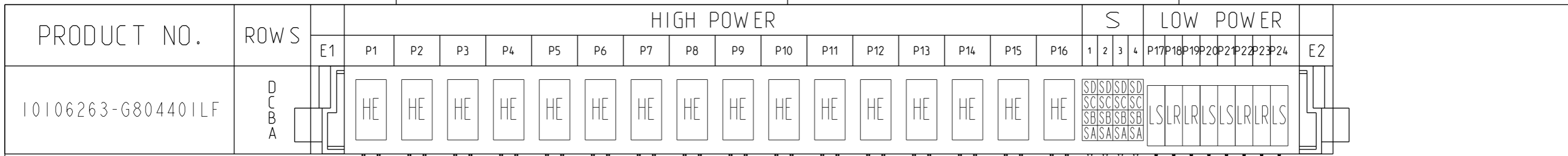

CODE	DESCRIPTION
HE	STD HIGH POWER CONTACT (3.05)
LR	MFBL LOW POWER CONTACT (3.05)
LS	STD LOW POWER CONTACT (3.05)
SA	STD SIGNAL CONTACT, ROW A (3.05)
SB	STD SIGNAL CONTACT, ROW B (3.05)
SC	STD SIGNAL CONTACT, ROW C (3.05)
SD	STD SIGNAL CONTACT, ROW D (3.05)

dr	Eddy Zeng	2014/12/25	projection	MM	size	A3	scale	3:2	
eng	Vicking Liu	2015/09/22			ecn no	ELX-DG-21958-1	rel level	Released	
chr	Fancy Zhang	2015/09/28							
appr	Pei-Ming Zheng	2015/09/28	product family	PwrBlade+					
			title 16HP + 16S + 8LP RA PF HEADER			dwg no 10106263-G804401		rev B	
www.fci.com			cat. no.		Product - Customer Drw			sheet 2 of 3	

Copyright FCI.

NOTES:

- 1) "FCI", PART NUMBER AND DATE CODE TO BE MARKED ON THIS SURFACE.
THE MARK CAN BE OMITTED IF THERE IS NOT ENOUGH SPACE ON THIS SURFACE.
- 2) MATERIALS:
-HOUSING - GLASS FILLED WITH HIGH TEMP THERMOPLASTIC, UL94V-0.
-SIGNAL CONTACT - COPPER ALLOY.
-POWER CONTACT - HIGH CONDUCTIVITY COPPER ALLOY.
- 3) PLATING SPECIFICATION : 10116351
- 4) DENOTES CONNECTOR KEEP OUT ZONE.
- 5) DATUM AND BASIC DIMENIONS ARE ESTABLISHED BY CUSTOMER.
- 6) ALL HOLE DIAMETERS ARE FINISHED HOLE SIZES.
- 7) 1.15±0.025MM DRILLED HOLE PLATED WITH 0.00762MM MIN Sn
OVER 0.0254-0.0762MM Cu PLATING TO ACHIEVE A 1.02±0.07MM HOLE.
- 8) PRODUCT SPECIFICATION : GS-12-658.
APPLICATION SPECIFICATION : GS-20-141.
PACKAGE SPECIFICATION: GS-14-1502(PRODUCT PACKAGED IN TRAYS).

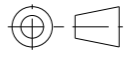
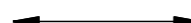

Copyright FCI.

dr	Eddy Zeng	2014/12/25	projection 	MM 	size	A3	scale	3:2	
eng	Vicking Liu	2015/09/22			ecn no	ELX-DG-21958-1			
chr	Fancy Zhang	2015/09/28			product family	PwrBlade+	rel level	Released	
appr	Pei-Ming Zheng	2015/09/28			title	16HP + 16S + 8LP		rev	B
		www.fci.com	cat. no.	Product - Customer Drw			dwg no	10106263-G804401	sheet 3 of 3