

PCB connection terminal block - PT-SG/ 1 8X0,1-2 THR2,1 R24 - 1841830

Please be informed that the data shown in this PDF Document is generated from our Online Catalog. Please find the complete data in the user's documentation. Our General Terms of Use for Downloads are valid (<http://phoenixcontact.com/download>)



PCB terminal block without insulating housing for contacting, e.g., flat-ribbon conductors, contact pins or PCBs, nominal current: 41 A, 1-pos., connection method: spring connection, mounting: THT/THR, user information on THT/THR technology can be found under "Downloads"



Key commercial data

Packing unit	1 pc
Minimum order quantity	250 pc
Weight per Piece (excluding packing)	4.64 GRM
Custom tariff number	85369010
Country of origin	Germany

Technical data

Dimensions

Pin dimensions	0,5 x 1
Hole diameter	1.4 mm

General

Range of articles	PT-SG
Nominal current I_N	41 A
Nominal cross section	6 mm ²
Solder pin surface	Sn
Number of positions	1

Connection data

Conductor cross section solid min.	0.25 mm ²
Conductor cross section solid max.	2.5 mm ²
Conductor cross section stranded, with ferrule without plastic sleeve min.	0.25 mm ²
Conductor cross section stranded, with ferrule without plastic sleeve max.	2.5 mm ²
Conductor cross section stranded, with ferrule with plastic sleeve min.	0.25 mm ²

PCB connection terminal block - PT-SG/ 1 8X0,1-2 THR2,1 R24 - 1841830

Technical data

Connection data

Conductor cross section stranded, with ferrule with plastic sleeve max.	2.5 mm ²
Conductor cross section AWG/kcmil min.	22
Conductor cross section AWG/kcmil max	14
Max. width of flat-ribbon conductor	8 mm
Min. height of flat-ribbon conductor	0.1 mm
Max. height of flat-ribbon conductor	2 mm
Stripping length	3.5 mm ... 7 mm (Avoid tensile force on the terminal point)

Classifications

eCl@ss

eCl@ss 5.1	27141190
eCl@ss 6.0	27261101
eCl@ss 8.0	27440401

ETIM

ETIM 5.0	EC002498
----------	----------

Drawings

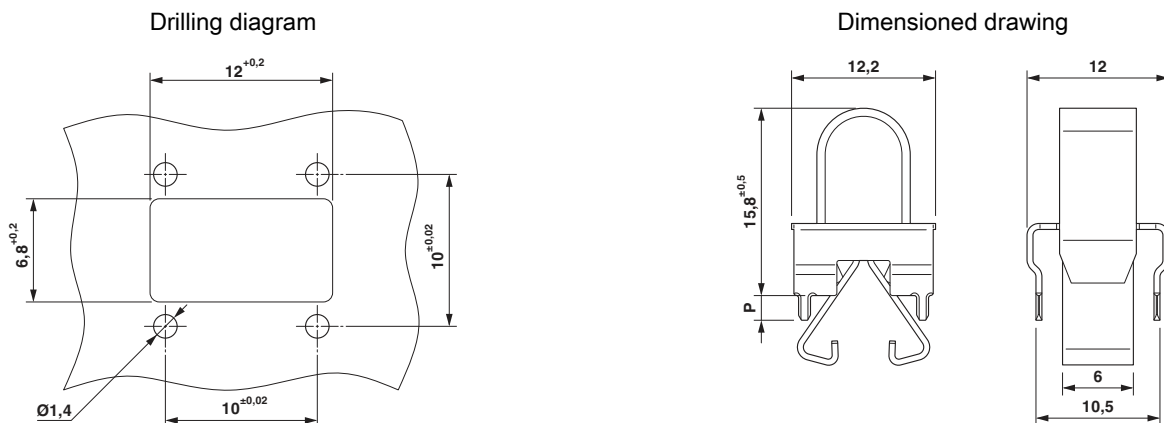

Dimension P= 2.1 mm

PCB connection terminal block - PT-SG/ 1 8X0,1-2 THR2,1 R24 - 1841830

Diagram

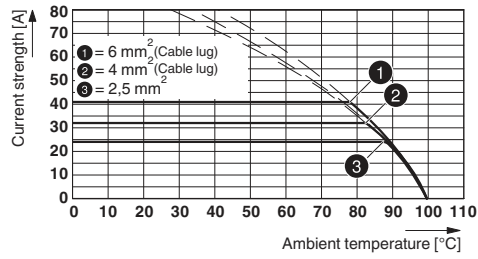

Type: PT-SG/ 1 8X0,1-2 THR... R24
Tested in accordance with DIN EN 60512-5-2:2003-01
Reduction factor = 1
Number of positions: 1