

Preliminary Technical Document**Evaluation Board for AD5689R AD5687R, Quad, 16-/12-Bit, Serial Voltage-Output
DAC****FEATURES**

Full-featured evaluation board for the [AD5689R AD5687R](#)
On-board reference
Various link options
PC control in conjunction with Analog Devices
System demonstration platform (SDP)
PC software for control of DACs
On-board ADC for voltage readback

PACKAGE CONTENTS

AD5689R/87R evaluation board
AD5689R or AD5687R device
CD that includes
Self-installing software that allows users to control the
board and exercise all functions of the device
Electronic version of the AD5689R data sheet
Electronic version of Evaluation Board Document

GENERAL DESCRIPTION

The Analog Devices, Inc., AD5689R / AD56887R evaluation board (EVAL-AD5689RSDZ and AD5687RSDZ) is designed to help customers quickly prototype new AD5687R/89R circuits and reduce design time. The AD5689R/89R operates from a single 2.7 V to 5.5 V supply. The part incorporates an internal 2.5 V

on-board reference to give an output voltage span of 2.5 V or 5 V. The on-board reference is on at power-up.

The part must be written to after power-up to turn off the internal reference.

Full data on the AD5689R/87R may be found in the data sheet available from Analog Devices and should be consulted in conjunction with this data sheet when using the evaluation board.

The evaluation board interfaces to the USB port of an IBM compatible PC via the SDP board. Software is available with the evaluation board which allows the user to easily program the AD5689R/87R and simulation mode is available.

This evaluation board requires the EVAL-SDP-CB1Z board. This is available on the Analog Devices website.



Figure 1. Universal Evaluation Board

EVALUATION BOARD HARDWARE

POWER SUPPLIES

To power the AD5689R/87R evaluation board supply 6V between the +6V and AGND inputs of the evaluation board.

Both AGND and DGND inputs are provided on the board. The AGND and DGND planes are connected at one location close to the AD5689R/87R. It is recommended not to connect AGND and DGND elsewhere in the system to avoid ground loop problems.

All supplies are decoupled to ground with 10 μ F tantalum and 0.1 μ F ceramic capacitors.

Table 1. Power Supply Connectors

Connector No.	Voltage
J1	Analog positive power supply, VDD.
J2	Digital positive power supply, VDD.
J3	+6V board positive power supply, VDD. Supply 6V for board operation.

LINK OPTIONS

A number of link and switch options are incorporated in the evaluation board and should be set for the required operating setup before using the board. The functions of these link options are described in detail in Table 3. Table 2 describes the positions of the different links to control the evaluation board by PC, via the USB port and SDP board in single-supply mode.

Table 2. Link Options Setup for SDP Control (Default)

Link No.	Options
LK1	A
LK2	A
LK3	C
LK4	B
LK5	A
LK6	B

Table 3. Link Functions

Link No.	Option
LK1	This Link selects the DAC analog voltage source: <ul style="list-style-type: none"> • Position A selects the internal voltage source from the ADP3331 • Position B selects an external supply voltage(EXT_VDD)
LK2	This Link selects the DAC digital voltage source: <ul style="list-style-type: none"> • Position A selects the digital voltage source from SDP board • Position B selects an external digital supply voltage(EXT_VL)
LK3	This link selects the reference source: <ul style="list-style-type: none"> • Position A selects the on-board 2.5 V reference as the reference source. • Position B selects the on-board 5 V reference as the reference source. • Position C selects the internal reference as the reference source. • Position D selects an off board voltage reference via the EXT_REF connector.
LK4	This link selects the GAIN setting of the AD5689R/87R(not populated): <ul style="list-style-type: none"> • Position A selects GAIN=x2. • Position B selects GAIN=x1.
LK5	This link selects the GAIN setting of the AD5689R/87R: <ul style="list-style-type: none"> • Position A selects GAIN=x2. • Position B selects GAIN=x1.
LK6	This link selects the /SYNC setting: <ul style="list-style-type: none"> • Position B selects the AD5689R.

EVALUATION BOARD SOFTWARE

INSTALLING THE SOFTWARE

The EVAL-AD568XRRSDZ evaluation kit includes self-installing software on CD. The software is compatible with Windows® XP, Windows Vista (32-bits) and Windows 7 (32-bits). When users need drivers for 64-bit operating systems, contact Linear.Apps@analog.com.

Install the software before connecting the SDP board to the USB port of the PC. This ensures that the SDP board is recognized when it connects to the PC.

1. Start the Windows® operating system and insert CD.
2. The installation software must open automatically. If it does not, run the **setup.exe** file from the CD.
3. After installation is completed, power-up the evaluation board as described in the Power Supplies section
4. -. Plug the EVAL-AD568XRSZ into the SDP board and the SDP board into the PC using the USB cable included in the box.
5. When the software detects the evaluation board, proceed through any dialog boxes that appear to finalize the installation.

RUNNING THE SOFTWARE

To run the program, do the following:

1. Click **Start > All Programs > Analog Devices > AD56xR > AD568xR Evaluation Software**. To uninstall the program, click **Start > Control Panel > Add or Remove Programs > AD568xR Evaluation Software**.
2. If the SDP board is not connected to the USB port when the software is launched, a connectivity error is displayed (see Figure 2). Simply connect the evaluation board to the USB port of the PC, wait a few seconds, click **Rescan**, and follow the instructions.

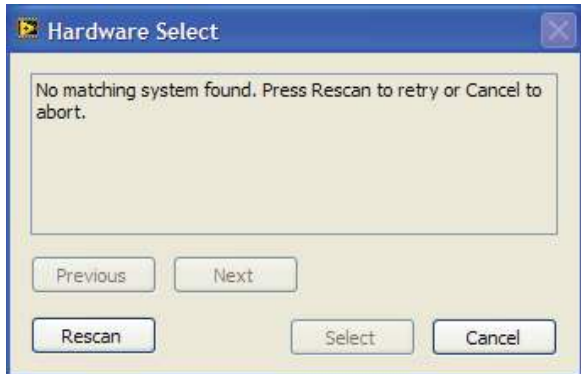

Figure 2. Pop-Up Window Error

3. If the SDP board is not connected to the evaluation boards a message box appears as shown in Figure 3. Check the connection between the SDP and EVAL-AD568xSDZ boards or use simulation mode.



Figure 3. Error Message

4. If the SDP board is connect the System Development Platform will connect for a brief period.



Figure 4. System Develop Platform Wait Window

5. The main window of the AD5689R/87R evaluation software then opens, as shown in Figure 5.

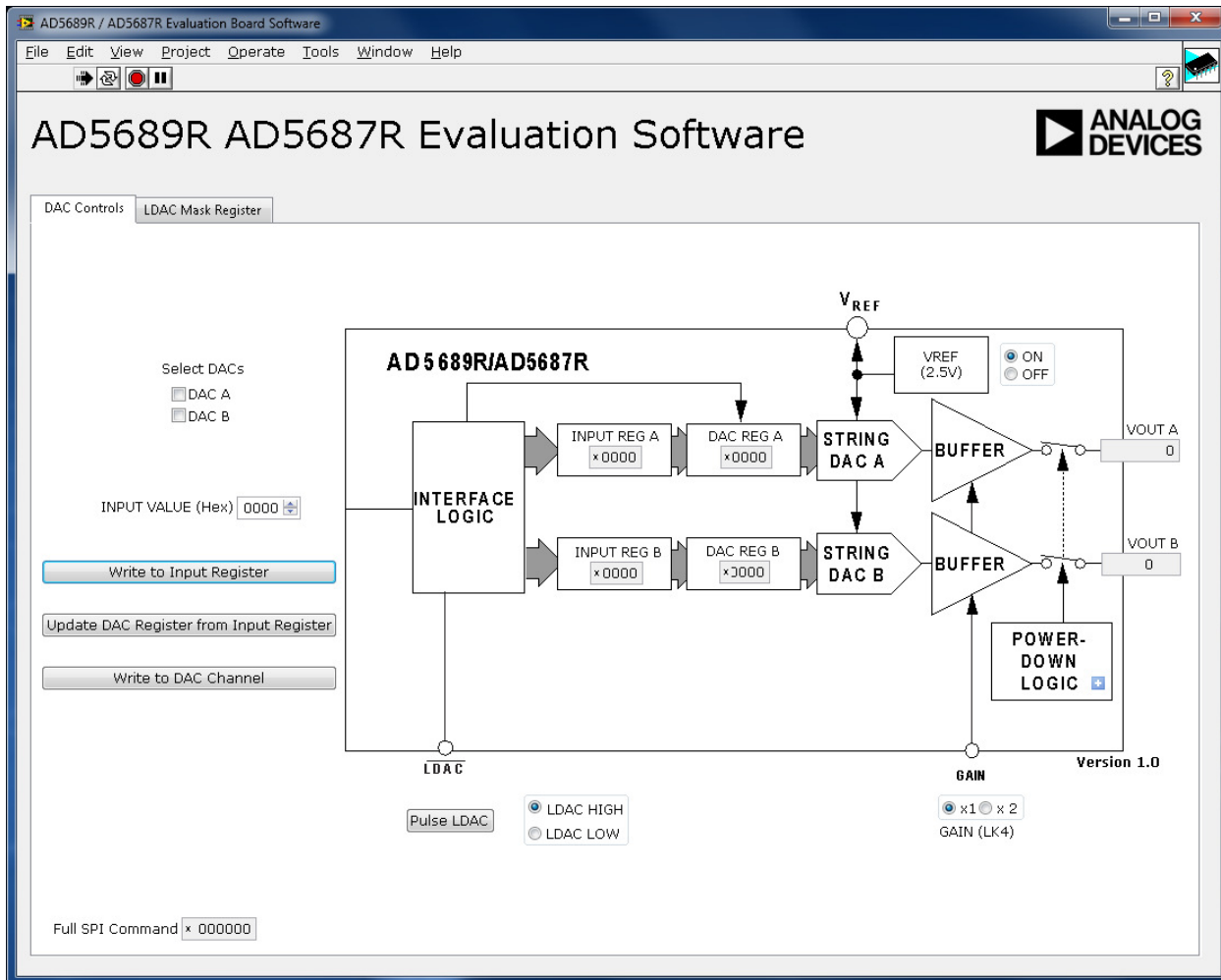

Figure 5. AD568xR Evaluation Board Main Window

SOFTWARE OPERATION

To select the AD5689R: From the **Analog Devices** menu, click **Start > All Programs >**

Analog Devices > AD568xR > AD568xR SDP Evaluation Software.

To select the AD5687R: From the **Analog Devices** menu, click **Start > All Programs >**

Analog Devices > AD568xR > AD568xR SDP Evaluation Software.

For older PCs, click **Start > Programs > Analog Devices > AD568xR > AD568xR SDP Evaluation Software.**

The AD568xR main window opens, as shown in Figure 5. The data programmed into the 32 bit input shift register is displayed. You can select the command bits, the address bits and the data bits by clicking the appropriate button under each area.

To select a command with which to program the part, select the appropriate option from the drop down menu under **Command Menu**. For example, to program all DAC outputs with fullscale click “Write to and Update DAC channel n”. Click the DAC channels you wish to update.

Under **Data Bits**, type the data in decimal format. To execute click **Write to Part**. You must click **Write to Part** to execute all writes to the part.

Other AD568xR Commands are available by selecting the drop down menu under **Command Menu** and clicking **Write to Part**. You can also set the register bits for the required mode of operation. Consult the AD568xR datasheet for details. Set /LDAC and /RESET to High or Low by clicking the corresponding checkbox under **Hardware Pins**. This command is executed immediately so there is no need to click **Write to Part**.

EVALUATION BOARD SCHEMATICS AND ARTWORK

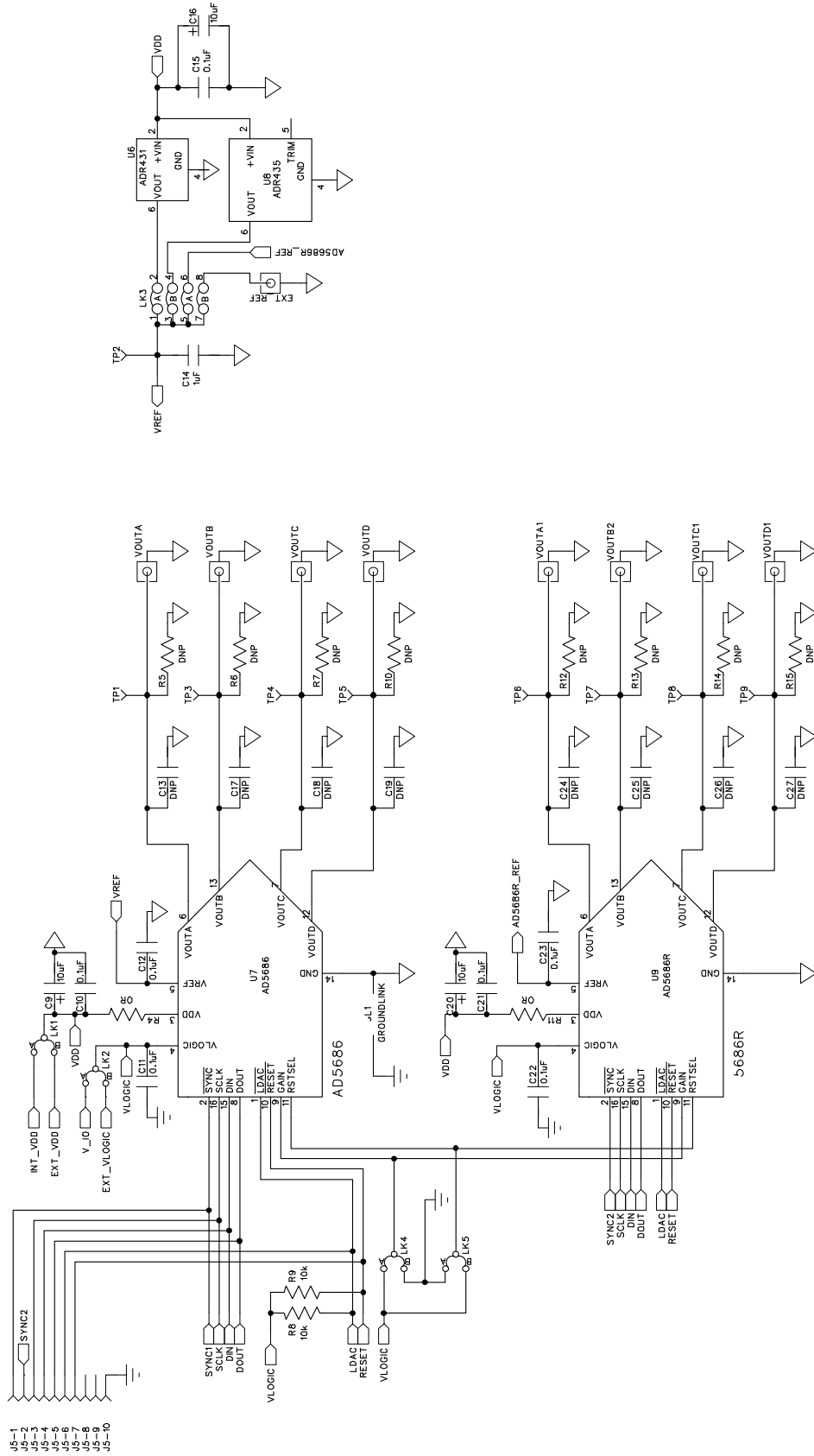

Figure 6. Schematic of AD5686R Evaluation Circuitry

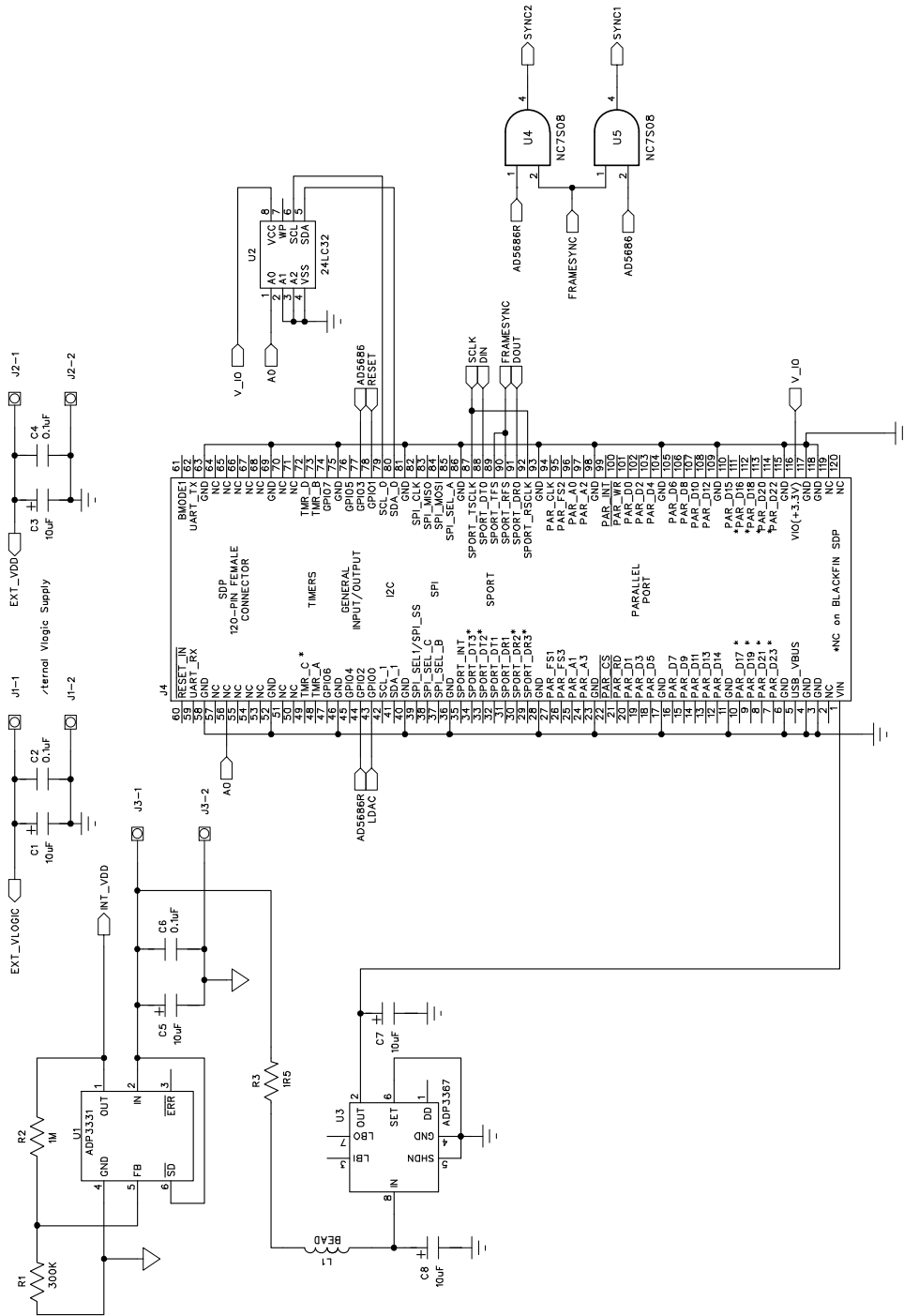

Figure 7. Schematic of SDP Connector

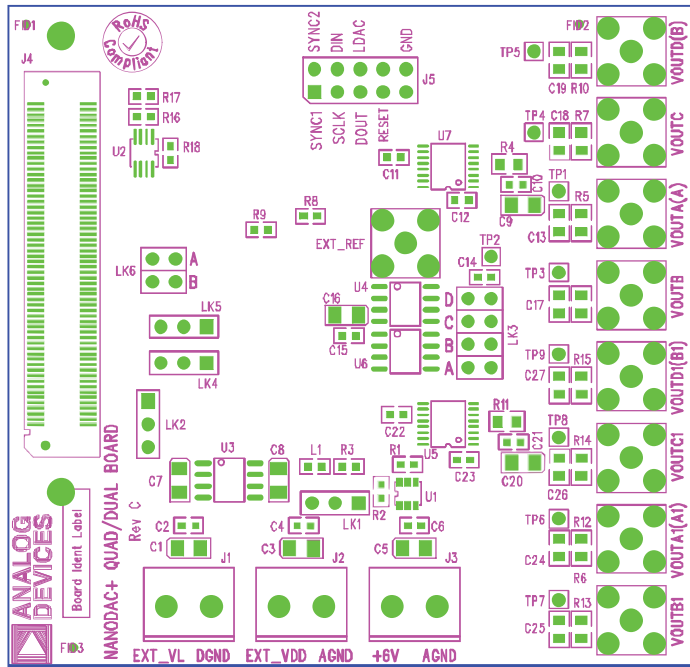

Figure 8. AD568x(R) Component Silkscreen

10954-007

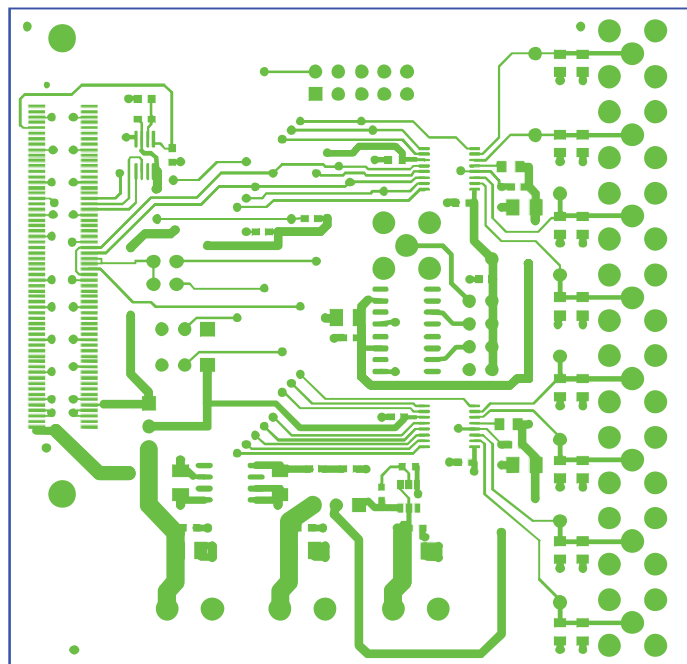

Figure 9. AD568x(R) Top Side Routing

10954-008

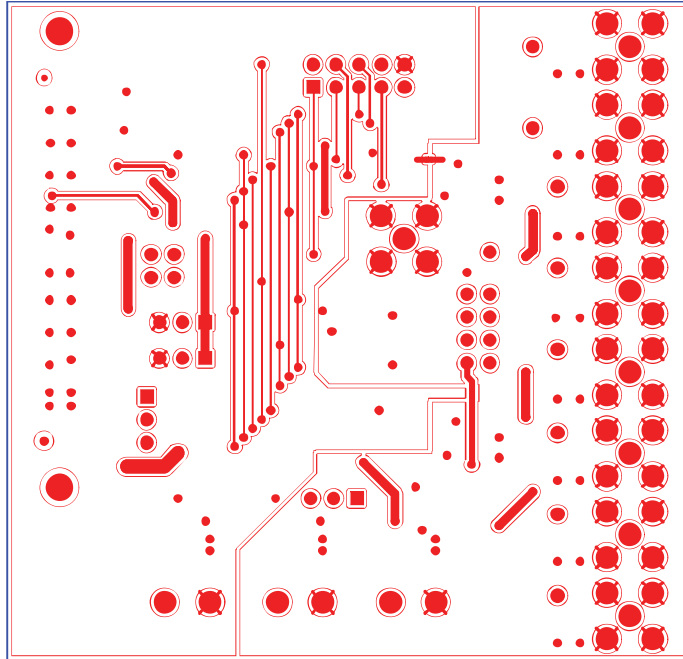

Figure 10. AD568x(R) Bottom Side Routing

ORDERING INFORMATION

COMPONENTS LIST

Table 4.

Qty	Reference Designator	Description	Supplier/Part Number
1	U5	AD5689R or AD5687R	Analog Devices AD5689R or AD5687R
1	U7	AD5686 or AD5684	Analog Devices AD5686 or AD5684
2	R4, R11	RESISTOR, 0805 0R0	FEC 9333681
9	VOUTA, VOUTA1, VOUTB, VOUTB1, VOUTC, VOUTC1, VOUTD, VOUTD1, EXT_REF	SMB Jack 50 Ohm	FEC1206013
		120-Way Female Connector	FEC 1324660
		32k I2C Serial EEPROM	FEC 1331330
3	J1, J2, J3	2 Pin Terminal Block	FEC 151789
1	J4	120 Pin Female Connector	FEC 1324660
3	J5, LK3, LK6	10 Pin Terminal Block, 8 Pin (4x2) 0.1" Header	FEC 1022244
8	C1, C3, C5, C7, C8, C9, C16, C20	Case A 10uF Capacitor	FEC 197-130
10	C2, C4, C6, C10, C11, C12, C15, C21, C22, C23	CAPACITOR, 100NF, 50V, 0603	FEC 8820023
1	C14	CAPACITOR, 0603, 1UF, 10V	FEC 318-8840
9	TP1-TP9	Red Testpoint	FEC 8731144 (Pack)
2	R8, R9	10K SMD Resistor	FEC 9330399
2	R17, R18	100K SMD Resistor	FEC 9330402
1	R1	0603 300K Resistor	Digikey 541-300KHCT-ND
1	R2	RESISTOR, 1M, 1%, 0.063W, 0603	Digikey RMCF1/161MFRCT-ND
1	R3	Resistor, 1R5, 5%, 0.063W, 0603	FEC 9331832
1	L1	Ferrite Bead, 600 ohms @ 100MHz	Digikey 490-1024-1-ND
		Octal Buffer/Line Driver	FEC 9591915
4	LK1, LK2, LK4, LK5	JUMPER BLOCK USING 3 PIN SIP HEADER	FEC 1022248
1	U1	Adjustable LDO Regulator	Analog Devices ADP3331
1	U2	32K I2C Serial EEPROM	FEC 1331330
1	U3	+5V Fixed, Adjustable Voltage Regulator	Analog Devices ADP3367
1	U6	Voltage Reference	Analog Devices REF431
1	U4	Voltage Reference	Analog Devices REF435

NOTES

NOTES

NOTES

**ESD Caution**

ESD (electrostatic discharge) sensitive device. Charged devices and circuit boards can discharge without detection. Although this product features patented or proprietary protection circuitry, damage may occur on devices subjected to high energy ESD. Therefore, proper ESD precautions should be taken to avoid performance degradation or loss of functionality.

Legal Terms and Conditions

By using the evaluation board discussed herein (together with any tools, components documentation or support materials, the "Evaluation Board"), you are agreeing to be bound by the terms and conditions set forth below ("Agreement") unless you have purchased the Evaluation Board, in which case the Analog Devices Standard Terms and Conditions of Sale shall govern. Do not use the Evaluation Board until you have read and agreed to the Agreement. Your use of the Evaluation Board shall signify your acceptance of the Agreement. This Agreement is made by and between you ("Customer") and Analog Devices, Inc. ("ADI"), with its principal place of business at One Technology Way, Norwood, MA 02062, USA. Subject to the terms and conditions of the Agreement, ADI hereby grants to Customer a free, limited, personal, temporary, non-exclusive, non-sublicensable, non-transferable license to use the Evaluation Board FOR EVALUATION PURPOSES ONLY. Customer understands and agrees that the Evaluation Board is provided for the sole and exclusive purpose referenced above, and agrees not to use the Evaluation Board for any other purpose. Furthermore, the license granted is expressly made subject to the following additional limitations: Customer shall not (i) rent, lease, display, sell, transfer, assign, sublicense, or distribute the Evaluation Board; and (ii) permit any Third Party to access the Evaluation Board. As used herein, the term "Third Party" includes any entity other than ADI, Customer, their employees, affiliates and in-house consultants. The Evaluation Board is NOT sold to Customer; all rights not expressly granted herein, including ownership of the Evaluation Board, are reserved by ADI. CONFIDENTIALITY. This Agreement and the Evaluation Board shall all be considered the confidential and proprietary information of ADI. Customer may not disclose or transfer any portion of the Evaluation Board to any other party for any reason. Upon discontinuation of use of the Evaluation Board or termination of this Agreement, Customer agrees to promptly return the Evaluation Board to ADI. ADDITIONAL RESTRICTIONS. Customer may not disassemble, decompile or reverse engineer chips on the Evaluation Board. Customer shall inform ADI of any occurred damages or any modifications or alterations it makes to the Evaluation Board, including but not limited to soldering or any other activity that affects the material content of the Evaluation Board. Modifications to the Evaluation Board must comply with applicable law, including but not limited to the RoHS Directive. TERMINATION. ADI may terminate this Agreement at any time upon giving written notice to Customer. Customer agrees to return to ADI the Evaluation Board at that time. LIMITATION OF LIABILITY. THE EVALUATION BOARD PROVIDED HEREUNDER IS PROVIDED "AS IS" AND ADI MAKES NO WARRANTIES OR REPRESENTATIONS OF ANY KIND WITH RESPECT TO IT. ADI SPECIFICALLY DISCLAIMS ANY REPRESENTATIONS, ENDORSEMENTS, GUARANTEES, OR WARRANTIES, EXPRESS OR IMPLIED, RELATED TO THE EVALUATION BOARD INCLUDING, BUT NOT LIMITED TO, THE IMPLIED WARRANTY OF MERCHANTABILITY, TITLE, FITNESS FOR A PARTICULAR PURPOSE OR NON-INFRINGEMENT OF INTELLECTUAL PROPERTY RIGHTS. IN NO EVENT WILL ADI AND ITS LICENSORS BE LIABLE FOR ANY INCIDENTAL, SPECIAL, INDIRECT, OR CONSEQUENTIAL DAMAGES RESULTING FROM CUSTOMER'S POSSESSION OR USE OF THE EVALUATION BOARD, INCLUDING BUT NOT LIMITED TO LOST PROFITS, DELAY COSTS, LABOR COSTS OR LOSS OF GOODWILL. ADI'S TOTAL LIABILITY FROM ANY AND ALL CAUSES SHALL BE LIMITED TO THE AMOUNT OF ONE HUNDRED US DOLLARS (\$100.00). EXPORT. Customer agrees that it will not directly or indirectly export the Evaluation Board to another country, and that it will comply with all applicable United States federal laws and regulations relating to exports. GOVERNING LAW. This Agreement shall be governed by and construed in accordance with the substantive laws of the Commonwealth of Massachusetts (excluding conflict of law rules). Any legal action regarding this Agreement will be heard in the state or federal courts having jurisdiction in Suffolk County, Massachusetts, and Customer hereby submits to the personal jurisdiction and venue of such courts. The United Nations Convention on Contracts for the International Sale of Goods shall not apply to this Agreement and is expressly disclaimed.