

Triple/Dual-Mode CDMA LNA/Mixers

MAX2338

General Description

The MAX2338 receiver RF front-end IC is designed for dual-band CDMA cellular phones and can also be used in dual-band TDMA, GSM, or EDGE cellular phones. Thanks to the MAX2338's on-chip low-power LO divider, the cellular VCO module can be eliminated.

The MAX2338 includes a low-noise amplifier (LNA) with an adjustable high-input third-order intercept point (IIP3) to minimize intermodulation and cross-modulation in the presence of large interfering signals. For cellular band operation, a low-gain LNA is available for higher cascaded IIP3 at lower current.

The CDMA mixers are designed for high linearity, low noise, and differential IF outputs. The FM mixer is designed for lower current and single-ended output.

The MAX2338 triple-mode LNA/mixer includes an on-chip LO frequency divider to allow the use of a single VCO for both bands. This device is available in an ultra-small 28-pin leadless QFN package.

Applications

Dual-Band, Triple-Mode PCS/Cellular Phones
Dual-Mode Cellular Phones

Features

- ◆ 1.4dB LNA Noise Figure
- ◆ 15dB LNA Gain
- ◆ Mixer Noise Figure
 - 7.5dB (CDMA)
 - 8.7dB (AMPS)
- ◆ Mixer Gain
 - 14.5dB PCS
 - 13.3dB Cellular
 - 8.8dB AMPS
- ◆ LO Frequency Divider, Saves VCO Module
- ◆ LO Output Buffers for TX
- ◆ Ultra-Small 28-Pin Leadless Package

Ordering Information

PART	TEMP RANGE	PIN-PACKAGE
MAX2338EGI	-40°C to +85°C	28 QFN

Pin Configuration/ Functional Diagram

Typical Operating Circuit appears at end of data sheet.

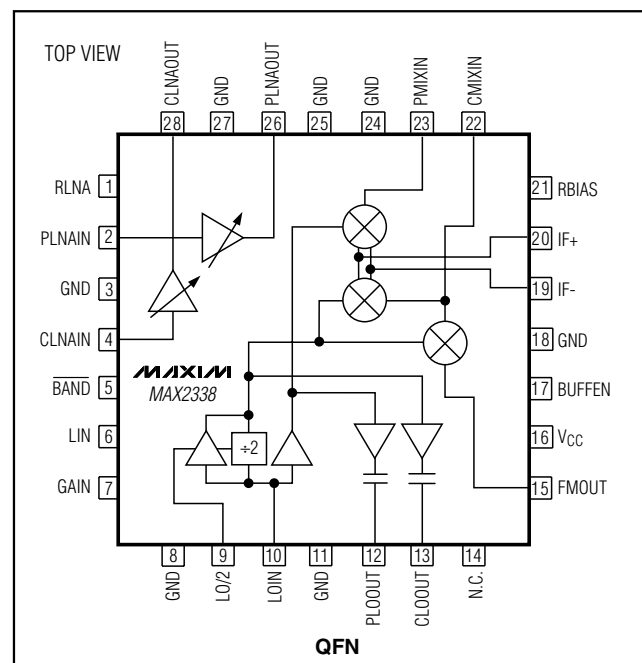

Triple/Dual-Mode CDMA LNA/Mixers

ABSOLUTE MAXIMUM RATINGS

V_{CC} to GND+0.3V to +4.3V
 Digital Input Voltage to GND-0.3V to (V_{CC} + 0.3V)
 LNA Input Level.....1V peak
 LO, Mixer Input Levels+5dBm
 Digital Input Current±10mA
 Continuous Power Dissipation (T_A = +70°C)
 28-Pin QFN (derate 28.5mW/°C above T_A = +70°C).....2W

Operating Temperature Range-40°C to +85°C
 Junction Temperature+150°C
 Storage Temperature Range-65°C to +150°C
 Lead Temperature (soldering, 10s) +300°C

Stresses beyond those listed under "Absolute Maximum Ratings" may cause permanent damage to the device. These are stress ratings only, and functional operation of the device at these or any other conditions beyond those indicated in the operational sections of the specifications is not implied. Exposure to absolute maximum rating conditions for extended periods may affect device reliability.

DC ELECTRICAL CHARACTERISTICS

(V_{CC} = +2.7V to +3.3V, R_{RBIAS} = R_{RLNA} = 24kΩ, BUFFEN = LOW, all RF and IF outputs connected to V_{CC}, no RF applied, T_A = -40°C to +85°C. Typical values are at +3.0V and T_A = +25°C, unless otherwise noted. Refer to Operational Modes table for control logic.)

PARAMETER	CONDITIONS		MIN	TYP	MAX	UNITS
PCS CDMA MODES						
Operating Supply Current	High-gain, low-linearity mode			18	24	mA
	High-gain, high-linearity mode			25	33	
CELLULAR CDMA MODE						
Operating Supply Current	Low-gain mode			19.5	25	mA
	High-gain, low-linearity mode			18	24	
	High-gain, high-linearity mode			28	35	
FM MODE						
Operating Supply Current				13.5	17	mA
SHUTDOWN MODE						
Shutdown Supply Current				0.1	5	μA
ALL MODES						
LO Buffer Supply Current	BUFFEN = HIGH	LO/2 = LOW		7.2	9.5	mA
		LO/2 = HIGH		10.3		
Additional Operational Current Divider Active	Cellular and FM mode; LO/2 = HIGH			1.2		mA
Digital Input Logic High			2.0			V
Digital Input Logic Low					0.6	V
Digital Input High Current					5	μA
Digital Input Low Current			-25			μA

Triple/Dual-Mode CDMA LNA/Mixers

MAX2338

AC ELECTRICAL CHARACTERISTICS

(MAX2338 EV kit, $V_{CC} = +2.7V$ to $+3.3V$, $f_{PLNAIN} = f_{PMIXIN} = 1930MHz$ to $1990MHz$, $f_{CLNAIN} = f_{CMIXIN} = 869MHz$ to $894MHz$, $f_{IF} = 183MHz$, high side LO, LO/2 = LOW. All ports matched to 50Ω , $R_{RLNA} = R_{RBIAS} = 24k\Omega$, $T_A = -40^{\circ}C$ to $+85^{\circ}C$. Typical values are at $T_A = +25^{\circ}C$, $V_{CC} = +3.0V$, unless otherwise noted.)

PARAMETER	CONDITIONS	MIN	TYP	MAX	UNITS
OVERALL PERFORMANCE					
Low-Band RF Frequency Range		869		894	MHz
High-Band RF Frequency Range		1930		1990	MHz
Low-Band LO Frequency Range	After divider if active (Note 1)	950		1100	MHz
High-Band LO Frequency Range	(Note 1)	1750		2210	MHz
IF Frequency Range	(Note 1)	80		220	MHz
LO Input Level		-7	-3	0	dBm
CELLULAR LNA PERFORMANCE					
HIGH-GAIN, HIGH-LINEARITY MODES					
Gain (Note 2)		14.0	15.7	17.0	dB
Noise Figure (Note 3)	$T_A = +25^{\circ}C$		1.4	1.6	dB
Noise Figure Change Due to Temperature	$T_A = +25^{\circ}C$ to T_{MAX}		0.3		dB
IIP3 (Notes 3, 4)		9.5	12		dBm
CDMA HIGH-GAIN, LOW-LINEARITY MODE AND FM MODE					
Gain (Note 2)		13	14.7	16.5	dB
Noise Figure (Note 3)	$T_A = +25^{\circ}C$		1.4	1.7	dB
IIP3 (Note 3, 4)		2.5	5.5		dBm
CDMA LOW-GAIN MODE					
Gain (Note 2)		-4.0	-2.3	0	dBm
Noise Figure (Note 3)			5	6	dB
IIP3 (Notes 3, 4)		15	18		dBm
PCS LNA PERFORMANCE					
CDMA HIGH-GAIN, HIGH-LINEARITY MODE					
Gain (Note 2)		13.8	15.3	16.9	dB
Noise Figure (Note 3)	$T_A = +25^{\circ}C$		1.4	1.7	dB
Noise Figure Change Due to Temperature	$T_A = +25^{\circ}C$ to T_{MAX}		0.3		dB
IIP3 (Notes 3, 5)		5.0	7.7		dBm
CDMA HIGH-GAIN, LOW-LINEARITY MODE					
Gain (Note 2)		13.0	14.5	16.5	dB
Noise Figure (Note 3)	$T_A = +25^{\circ}C$		1.4	1.7	dB
IIP3 (Notes 3, 5)		2.5	7.5		dBm
CELLULAR MIXER PERFORMANCE					
CDMA HIGH-GAIN, HIGH-LINEARITY, AND LOW-GAIN MODES					
Gain (Note 2)		10.3	13.3	16.4	dB
Noise Figure (Note 3)	$T_A = +25^{\circ}C$		7.8	9.0	dB
IIP3 (Note 4)		3.0	5.5		dBm

Triple/Dual-Mode CDMA LNA/Mixers

AC ELECTRICAL CHARACTERISTICS (continued)

(MAX2338 EV kit, $V_{CC} = +2.7V$ to $+3.3V$, $f_{PLNAIN} = f_{PMIXIN} = 1930MHz$ to $1990MHz$, $f_{CLNAIN} = f_{CMIXIN} = 869MHz$ to $894MHz$, $f_{IF} = 183MHz$, high side LO, LO/2 = LOW. All ports matched to 50Ω , $R_{RLNA} = R_{RBIAS} = 24k\Omega$, $T_A = -40^\circ C$ to $+85^\circ C$. Typical values are at $T_A = +25^\circ C$, $V_{CC} = +3.0V$, unless otherwise noted.)

PARAMETER	CONDITIONS	MIN	TYP	MAX	UNITS
HIGH-GAIN, LOW-LINEARITY IDLE MODE					
Gain (Note 2)		10.1	13	16	dB
Noise Figure (Note 3)	$T_A = +25^\circ C$		7.3	9.0	dB
IIP3 (Notes 3, 4)		1.4	3.5		dBm
FM MODE					
Gain (Note 2)		6.0	8.8	11.1	dB
Noise Figure (Note 3)	$T_A = +25^\circ C$		8.7	11.0	dB
IIP3 (Note 4)		1.4	3.4		dBm
PCS MIXER PERFORMANCE					
CDMA HIGH-GAIN, HIGH-LINEARITY MODE					
Gain (Note 2)		11.7	14.5	17	dB
Noise Figure (Note 3)	$T_A = +25^\circ C$		7.8	9.0	dB
IIP3 (Notes 3, 5)		3.5	7.5		dBm
HIGH-GAIN, LOW-LINEARITY MODE					
Gain (Note 2)		11.2	14	16.2	dB
Noise Figure (Note 3)	$T_A = +25^\circ C$		7.2	9.0	dB
IIP3 (Note 5)		0.5	2.5		dBm
ALL MODES					
Mixer Output 1dB Compression			-1		dBm
4 x 5 Suppression (Note 6)			>45		dB
2 x 2 Input Intercept Point (Notes 3, 7)		25	33		dBm
LO Output Level (Note 3)	Into 50Ω or 100Ω load, BUFFEN = HIGH	-12	-6		dBm
LO Output Leakage	BUFFEN = LOW		-35		dBm
LO Emission at PCS LNA Input Port			-55		dBm
LO Emission at Cellular LNA Input Port			-55		dBm
LO Output Harmonic Suppression	BUFFEN = HIGH		-15		dBc
LO Output Noise Power	BUFFEN = HIGH	PCS band, 80MHz below LO	-161		dBm/Hz
		Cellular band, 45MHz below LO	-161		
RF Ports Return Loss	All active RF ports including 2-element matching		10		dB

Note 1: Operation over this frequency range may require the ports to be rematched for the desired operating frequency.

Note 2: MIN guaranteed by production test, MAX guaranteed by design and characterization.

Note 3: Guaranteed by design and device characterization.

Note 4: Two-tone IIP3. Tested at $f_{RF1} = 880MHz$, $f_{RF2} = 880.9MHz$, and power = $-25dBm/$ tone.

Note 5: Two-tone IIP3. Tested at $f_{RF1} = 1960MHz$, $f_{RF2} = 1961.25MHz$, and power = $-25dBm/$ tone.

Note 6: $f_{LO} = 1064MHz$, $f_{RF1} = 887.8MHz$ at $-30dBm$, $f_{RF2} = 881MHz$ at $-100dBm$. Performance is measured as P_{IF} due to $RF1 - P_{IF}$ due to $RF2$.

Note 7: $f_{LO} = 2143MHz$, $f_{RF1} = 2051.5MHz$ at $-35dBm$, $f_{RF2} = 1960MHz$ at $-100dBm$. Performance is measured as P_{IF} due to $RF1 - P_{IF}$ due to $RF2$.

Triple/Dual-Mode CDMA LNA/Mixers

MAX2338

Typical Operating Characteristics

($T_A = +25^\circ\text{C}$, unless otherwise noted.)

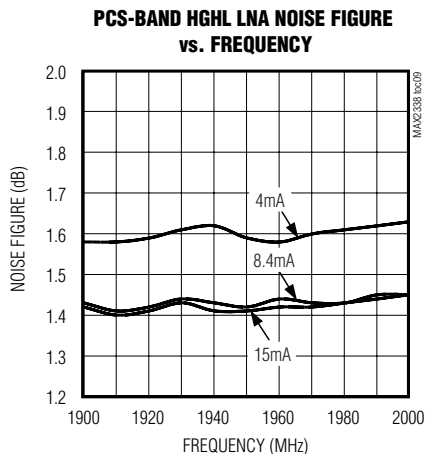
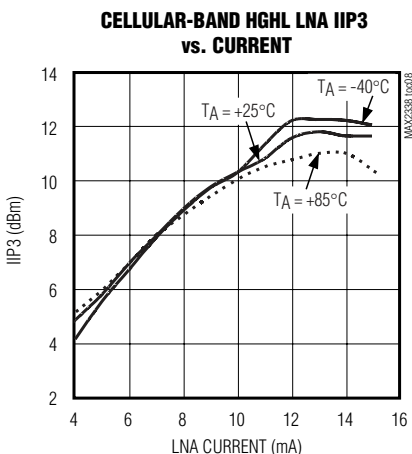
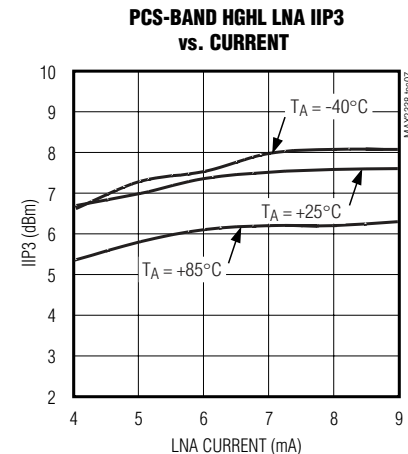
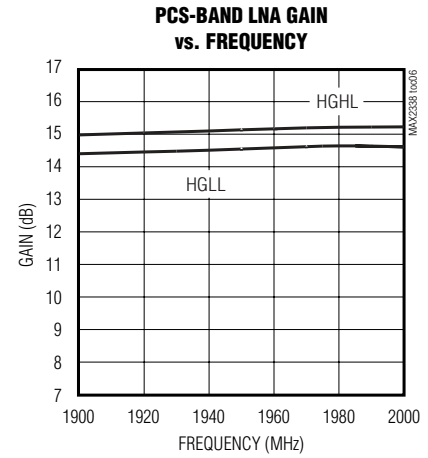
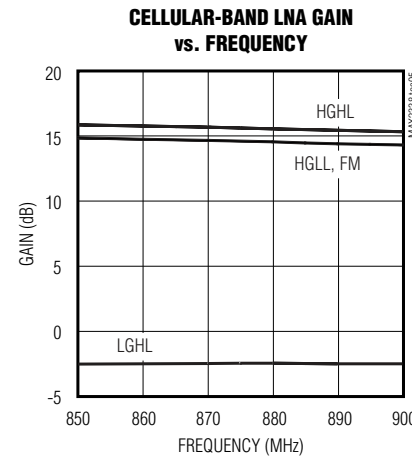
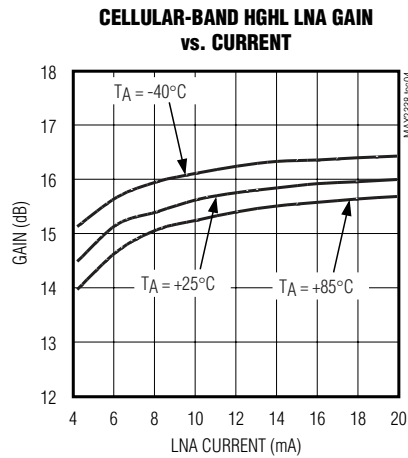
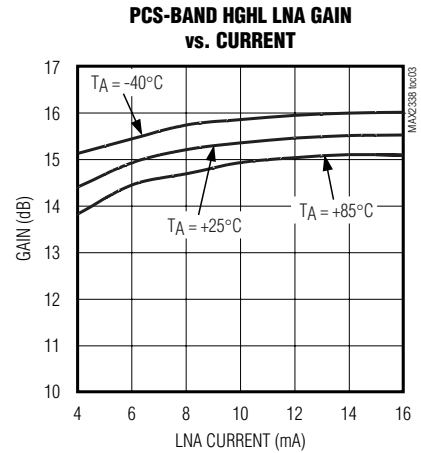
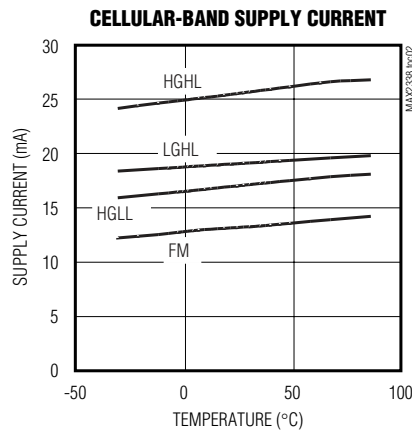
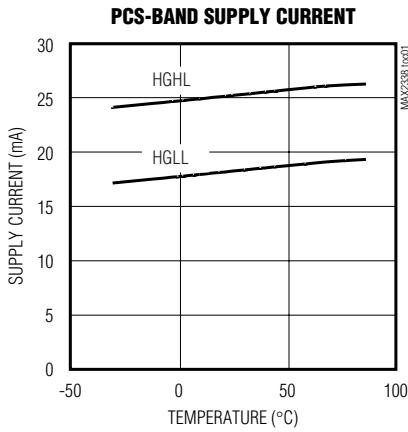

Triple/Dual-Mode CDMA LNA/Mixers

Typical Operating Characteristics (continued)

($T_A = +25^\circ\text{C}$, unless otherwise noted.)

CELLULAR-BAND HGHL LNA NOISE FIGURE vs. FREQUENCY

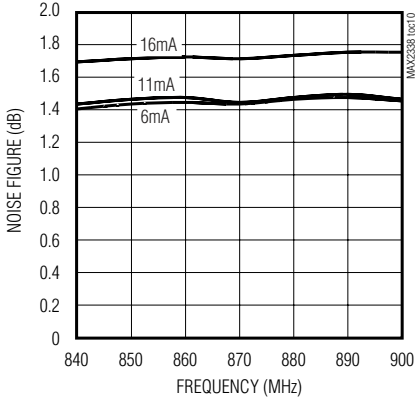

CELLULAR-BAND HGHL MIXER CONVERSION GAIN vs. CURRENT

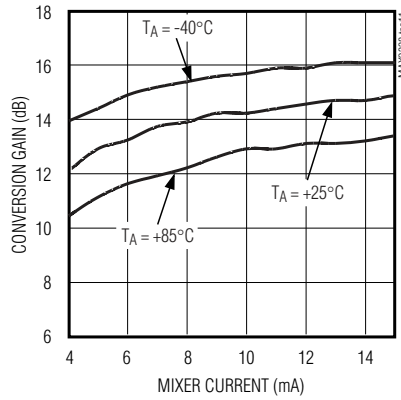

PCS-BAND MIXER CONVERSION GAIN vs. CURRENT

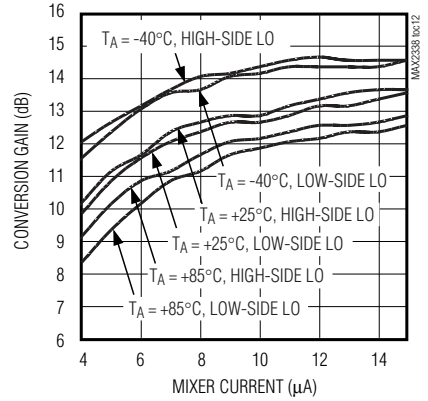

CELLULAR-BAND MIXER CONVERSION GAIN vs. LO INPUT LEVEL

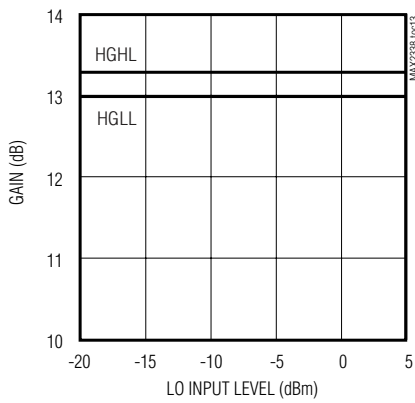

PCS-BAND MIXER CONVERSION GAIN vs. LO INPUT LEVEL

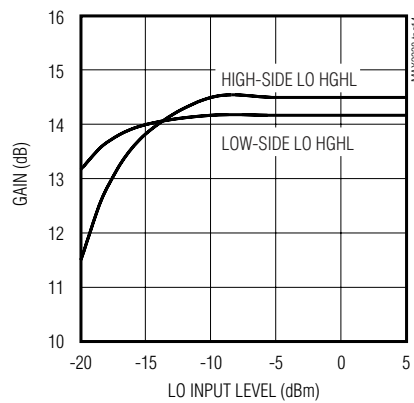

CELLULAR-BAND MIXER CONVERSION GAIN vs. RF INPUT LEVEL

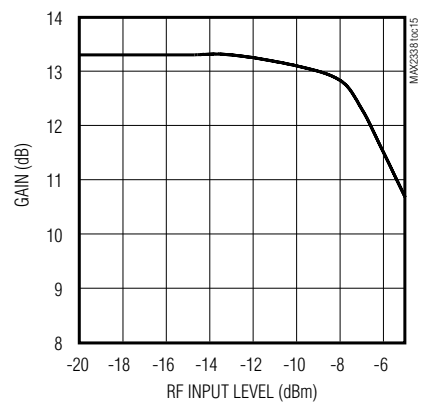

PCS-BAND MIXER CONVERSION GAIN vs. RF INPUT LEVEL

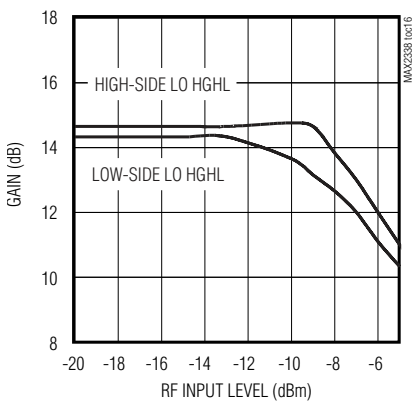

CELLULAR-BAND HGHL MIXER IIP3 vs. CURRENT

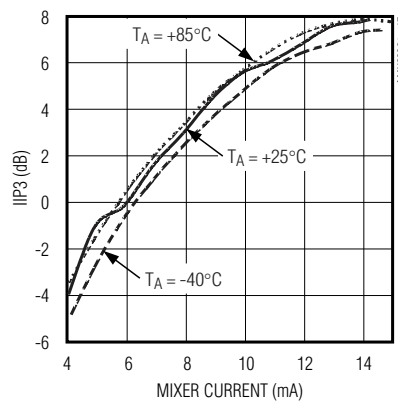

PCS-BAND HGHL MIXER IIP3 vs. CURRENT

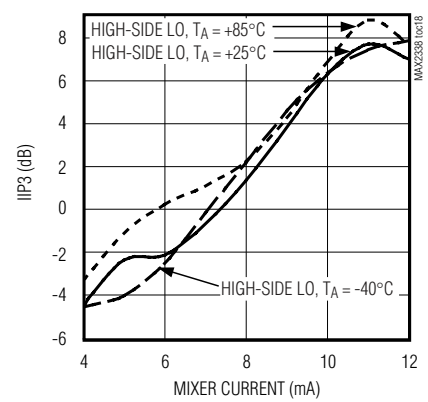

Triple/Dual-Mode CDMA LNA/Mixers

MAX2338

Typical Operating Characteristics (continued)

($T_A = +25^\circ\text{C}$, unless otherwise noted.)

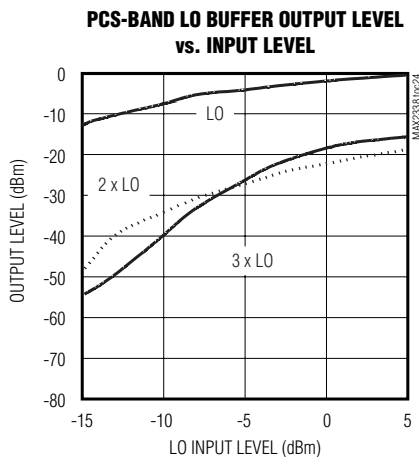
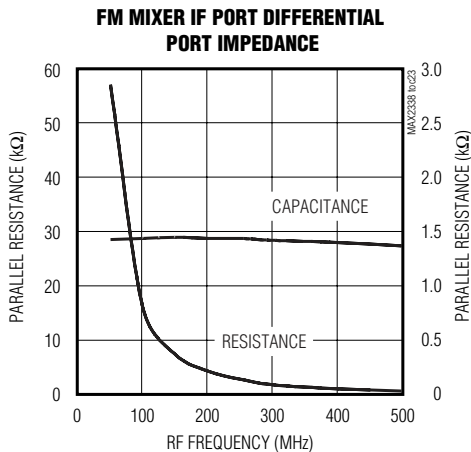
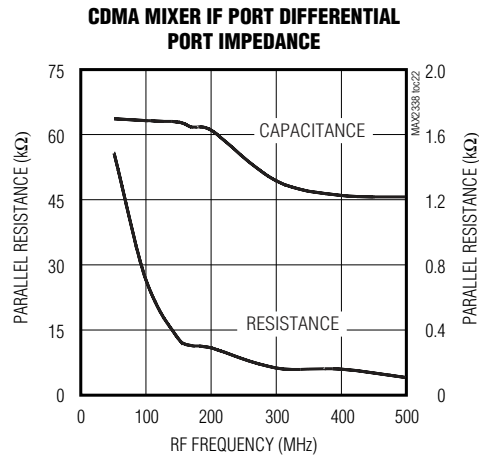
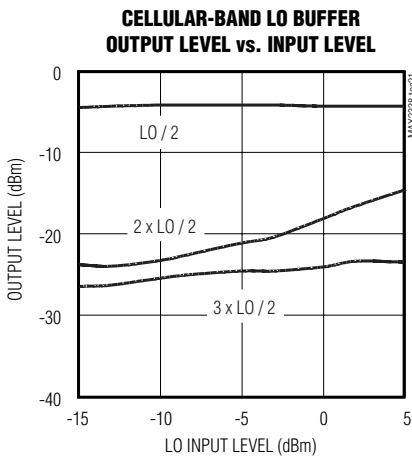
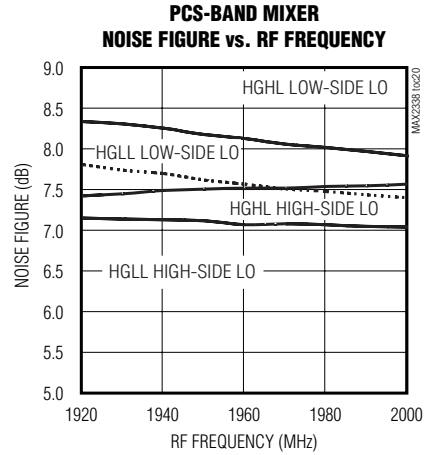
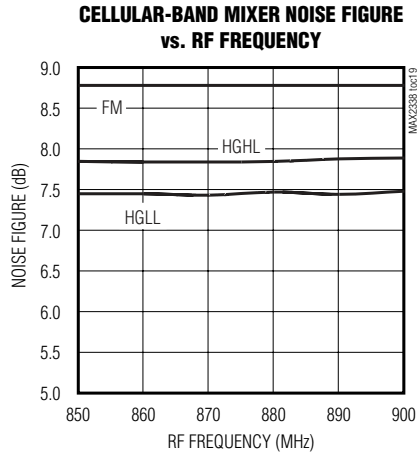

Triple/Dual-Mode CDMA LNA/Mixers

Pin Description

PIN	NAME	FUNCTION
1	RLNA	LNA Bias-Setting Resistor Connection. For nominal bias, connect a 24k Ω resistor to ground. The value of this resistor sets the bias current for HGHL LNAs.
2	PLNAIN	High-Band RF Input. Requires a blocking capacitor which may be used as part of the input matching network.
3, 8, 11, 18, 24, 25, 27, Exposed Paddle	GND	Ground Reference for RF, DC and Logic Inputs. Solder the exposed paddle evenly to the circuit board ground plane.
4	CLNAIN	Low-Band RF Input. Requires a blocking capacitor which may be used as part of the input matching network.
5	$\overline{\text{BAND}}$	Band-Select Logic Input. LOW selects high-band (PCS), HIGH selects low-band (cellular).
6	LIN	Linearity-Select Logic Input. See <i>Detailed Description</i> for control modes.
7	GAIN	Gain-Select Logic Input. See <i>Detailed Description</i> for control modes.
9	LO/2	LO Divider-Select Input. LOW disables LO divider, HIGH selects divider in cellular and FM modes. See <i>Detailed Description</i> for control modes.
10	LOIN	LO Input Port. Requires an external DC blocking capacitor.
12	PLOOUT	PCS LO Buffer Output Port. Internally matched to 100 Ω (nominal). Does not require a blocking capacitor.
13	CLOOUT	Cell LO Buffer Output Port. Internally matched to 100 Ω (nominal). Does not require a blocking capacitor. The output frequency is one half LOIN when LO/2 is floating or HIGH, and equal to LOIN when LO/2 is LOW.
14	NC	No Connection
15	FMOUT	FM Mixer Output Port. Requires pullup inductor and DC blocking capacitor, which may be used as part of the output matching network.
16	V _{CC}	Power Supply Pin. Bypass with capacitor as close to the pin as possible.
17	BUFFEN	LO Output Buffer Enable. Drive BUFFEN HIGH to power up the LO output buffer associated with the selected band.
19, 20	IF-, IF+	Mixer Differential Outputs. Require pullup inductors and series capacitors which can be used as part of the output matching network.
21	RBIAS	Bias Setting Resistor Connection. For nominal bias, connect a 24k Ω resistor to ground. The value of this resistor sets current for all blocks except HGHL LNA.
22	CMIXIN	Low-Band Mixer Input. Requires a blocking capacitor which may be used as part of the input matching network.
23	PMIXIN	High-Band Mixer Input. Requires a blocking capacitor which may be used as part of the input matching network.
26	PLNAOUT	High-Band LNA Output Port. Connect a pullup inductor to V _{CC} and an external series blocking capacitor which may be used as a part of the output matching network.
28	CLNAOUT	Low-Band LNA Output Port. Connect a pullup inductor to V _{CC} and an external series blocking capacitor which may be used as a part of the output matching network.

Triple/Dual-Mode CDMA LNA/Mixers

MAX2338

Detailed Description

The MAX2338 consists of cellular band and PCS band (LNAs) and mixers. The IC also consists of a local oscillator (LO) divider and LO buffers for cellular and PCS bands.

Low-Noise Amplifiers

The MAX2338 LNAs' gain and linearity are switched by the GAIN and LIN input, respectively. The PCS band LNA has two operational modes: high-gain high-linearity (HGHL) and high-gain low-linearity (HGLL). The cellular band LNA has three operational in modes: HGHL, HGLL, and low-gain high-linearity (LGHL) modes. The table in the *Operational Modes* section shows the pin settings for BAND, GAIN, and LIN for various operating modes. Use HGHL mode when extra high linearity is required for cross-modulation suppression, HGLL mode when the transmitter is off and cross-modulation is not a concern, and LGHL mode when receiving large signals.

Downconverter

The downconverters in these devices are double balanced mixers. The PCS band mixer and digital cellular band mixer share the same IF output ports. The cellular

band mixer has its own IF output to feed to a different filter. When the linearity requirement is high, the LIN control input increases the current in the downconverter. The downconverter requires a DC blocking capacitor at the input and output, and a pullup inductor at the output. The DC blocking capacitors can be designed to be part of the matching circuits. The table in the *Operational Modes* section shows the settings for BAND, GAIN, and LIN for various operating modes.

LO Output Buffers

There are two LO output buffers: cellular and PCS. The inputs are tied together and internally matched to 50Ω. The outputs of the PCS and cellular buffers are brought out separately. The outputs of the buffers are internally matched and include a DC blocking capacitor.

LO Divider

The MAX2338 includes an LO divider circuit which enables a single VCO for both cellular and PCS bands. The LO/2 logic input turns the divider on or off in the cellular band.

Table 1. Operational Modes

MODES	FUNCTION									CONTROL PIN			
	BAND (H/L)	LOX1	LO /2	HGHL Amp	HGLL Amp	LGHL Amp	CDMA HL Mixer	CDMA LL Mixer	FM Mixer	BAND	GAIN	LIN	LO/2
PCS Band, High-Gain, High-Linearity (HGHL)	H	✓		✓			✓			0	1	1	X
PCS Band, High-Gain, Low-Linearty (Idle Mode) (HGLL)	H	✓			✓			✓		0	1	0	X
Undefined	—	—	—	—	—	—	—	—	—	0	0	1	X
Cellular Band CDMA, High-Gain, High-Linearity (HGHL)	L		✓	✓			✓			1	1	1	1
Cellular Band CDMA, High-Gain, Low-Linearity (Idle Mode) (HGLL)	L		✓		✓			✓		1	1	0	1
Cellular Band, CDMA, Low-Gain	L		✓			✓	✓			1	0	1	1
Cellular Band, FM Mode	L		✓		✓				✓	1	0	0	1
Cellular Band CDMA, High-Gain, High-Linearity (HGHL)	L	✓		✓			✓			1	1	1	0
Cellular Band CDMA, High-Gain, Low-Linearity (Idle Mode) (HGLL)	L	✓			✓			✓		1	1	0	0
Cellular Band, CDMA, Low-Gain	L	✓				✓	✓			1	0	1	0
Cellular Band, FM Mode	L	✓			✓				✓	1	0	0	0
Shutdown										0	0	0	X

Triple/Dual-Mode CDMA LNA/Mixers

Operational Modes

The various operating modes are controlled by the logic inputs BAND, GAIN, LIN, and LO/2. Table 1 shows the pin settings for the various operating modes.

Applications Information

Cascaded LNA/Mixer Performance

The LNA and mixer design optimizes cascaded performance in all gain and linearity modes. In HGHL mode both the LNA and mixer have a low noise figure, high gain, and high linearity. The LNA has high gain to mini-

mize the noise contribution of the mixer, thus increasing the receiver's sensitivity, and the LNA has high linearity for cross-modulation suppression. The HGLL mode is used when the transmitter is off and cross-modulation is not a concern. In LGHL mode, the received signal is strong enough that linearity is the primary concern. The LNA gain is reduced for higher system linearity.

S-Parameters

Use the S-parameters listed in the following tables to design the RF matching circuits.

Table 2. MAX2338 Cellular Band LNA S-parameters High-Gain, High-Linearity Mode

FREQUENCY (MHz)	S ₁₁	∠S ₁₁	S ₂₁	∠S ₂₁	S ₁₂	∠S ₁₂	S ₂₂	∠S ₂₂
30	0.905	-5.4	0.145	-38	0.002	-55	0.98	-47
50	0.899	-8.1	0.467	-57	0.003	-126	0.94	-72
100	0.891	-15.1	1.34	-86	0.012	-174	0.96	-117
150	0.884	-21.8	2.2	-108	0.023	176	0.96	-144
200	0.874	-28.2	2.83	-127	0.027	165.8	0.95	-162
300	0.85	-41.6	3.77	-157.5	0.029	137	0.93	-172
400	0.818	-52.5	4.24	178.3	0.030	127	0.90	155
500	0.785	-63.5	4.44	155.4	0.036	112	0.94	129
600	0.75	-71.6	4.38	140	0.040	98	0.87	100
700	0.714	-79.8	4.16	125	0.048	90	0.84	78
800	0.683	-76.5	4.03	112.6	0.059	83.0	0.793	67.5
810	0.681	-77.0	4.01	111.2	0.060	82.8	0.798	66.5
820	0.677	-77.0	3.99	110.0	0.061	82.0	0.800	65.7
830	0.675	-78.0	3.97	108.5	0.061	80.9	0.799	65.0
840	0.670	-78.3	3.96	107.2	0.062	80.6	0.792	64.2
850	0.668	-78.8	3.93	106.4	0.063	79.2	0.782	63.4
860	0.665	-79.0	3.92	104.7	0.063	78.1	0.769	62.7
870	0.661	-79.5	3.91	103.4	0.063	77.2	0.753	61.8
880	0.660	-80.0	3.89	102.1	0.063	76.5	0.733	60.6
890	0.660	-80.4	3.87	100.8	0.063	75.4	0.710	59.4
900	0.653	-81.0	3.86	99.3	0.063	73.5	0.690	57.7
1000	0.614	-97.0	3.59	86.2	0.07	20	0.680	51.8
1250	0.547	-111	3.15	60.8	0.09	-13.2	0.650	37
1500	0.457	-131	2.93	34	0.109	-36	0.610	15.9
1750	0.310	-164	2.48	18	0.14	-62	0.580	-9.6
2000	0.320	166	2.1	-40	0.185	-98	0.490	-33
2500	0.300	141	1.62	-41	0.19	-150	0.360	-70
3000	0.310	122	1.29	-66	0.19	136	0.41	-64
3500	0.360	86	1.18	-88	0.2	90	0.500	-61
4000	0.360	10	1.14	-112	0.2	43	0.480	-50

Triple/Dual-Mode CDMA LNA/Mixers

MAX2338

Layout Considerations

Keep RF signal lines as short as possible to minimize losses and radiation. Use high Q components for the LNA input-matching circuit to achieve the lowest possible noise figure. At the digital mixer outputs, keep the differential signal lines together and of equal length to ensure signal balance. For best gain and noise performance, solder the exposed paddle evenly to the board ground plane.

Table 3. MAX2338 PCS Band LNA S-Parameters High-Gain, High-Linearity Mode

FREQUENCY (MHz)	S ₁₁	∠S ₁₁	S ₂₁	∠S ₂₁	S ₁₂	∠S ₁₂	S ₂₂	∠S ₂₂
30	0.890	-4.9	0.002	-95	0.001	-112	0.996	-48
50	0.883	-7.2	0.001	-60	0.001	-121	0.990	-73
100	0.872	-13.2	0.391	-81	0.002	-178	0.980	-114
200	0.841	-25	0.882	-112	0.007	171	0.970	-150
300	0.799	-35	1.42	-131	0.010	150	0.959	-166
400	0.778	-41	2.1	-153	0.02	125	0.947	-173
600	0.750	-62	2.15	-172	0.02	100	0.943	173
800	0.706	-75	2.2	162	0.025	80	0.944	151
1000	0.676	-85	2.45	150	0.029	65	0.919	133
1200	0.659	-94	2.59	142	0.032	42	0.879	115
1500	0.634	-108	3.03	134	0.036	31	0.824	94.4
1750	0.578	-110	3.58	126	0.038	19	0.780	81
1900	0.560	-90.8	3.64	120.6	0.04	11.8	0.740	61.7
1910	0.558	-91.0	3.64	119.6	0.04	9.06	0.738	60.7
1920	0.554	-91.4	3.64	118.9	0.04	8.8	0.733	59.6
1930	0.551	-91.7	3.63	118.2	0.04	6.7	0.729	58.5
1940	0.547	-92.2	3.63	117.7	0.04	5.3	0.725	57.4
1950	0.543	-92.2	3.63	117.0	0.04	4.87	0.720	56.1
1960	0.538	-92.4	3.63	116.5	0.04	4.1	0.716	55.0
1970	0.536	-92.5	3.61	115.9	0.04	1.8	0.716	53.6
1980	0.533	-92.9	3.60	115.2	0.04	1.5	0.711	52.3
1990	0.530	-93.0	3.59	114.7	0.04	0	0.707	50.9
2000	0.523	-93.4	3.57	113.0	0.04	-2.1	0.702	49.5
2250	0.347	-155	2.88	131	0.05	-32	0.518	24
2500	0.298	-158	2.71	172	0.05	-72	0.489	5
3000	0.273	-160	2.64	-165	0.06	-94	0.473	-18
4000	0.245	-170	2.03	-145	0.067	-120	0.425	-30

Triple/Dual-Mode CDMA LNA/Mixers

MAX2338

Table 4. MAX2338 Cellular Band Mixer Input S-Parameters High-Gain, High-Linearity Mode

FREQUENCY (MHz)	S ₁₁	∠S ₁₁
800	0.843	-67.5
810	0.843	-68.2
820	0.842	-68.8
830	0.842	-69.5
840	0.843	-70.2
850	0.843	-71.0
860	0.843	-71.6
870	0.843	-72.4
880	0.842	-73.0
890	0.841	-74.0
900	0.840	-75.0

Table 5. MAX2338 PCS Band Mixer Input S-Parameters High-Gain, High-Linearity Mode

FREQUENCY (MHz)	S ₁₁	∠S ₁₁
1900	0.762	-76.9
1910	0.759	-77.8
1920	0.755	-79.0
1930	0.752	-80.1
1940	0.747	-81.2
1950	0.744	-82.2
1960	0.741	-83.2
1970	0.739	-84.3
1980	0.734	-85.5
1990	0.730	-86.7
2000	0.723	-87.9

Triple/Dual-Mode CDMA LNA/Mixers

Typical Operating Circuit

MAX2338

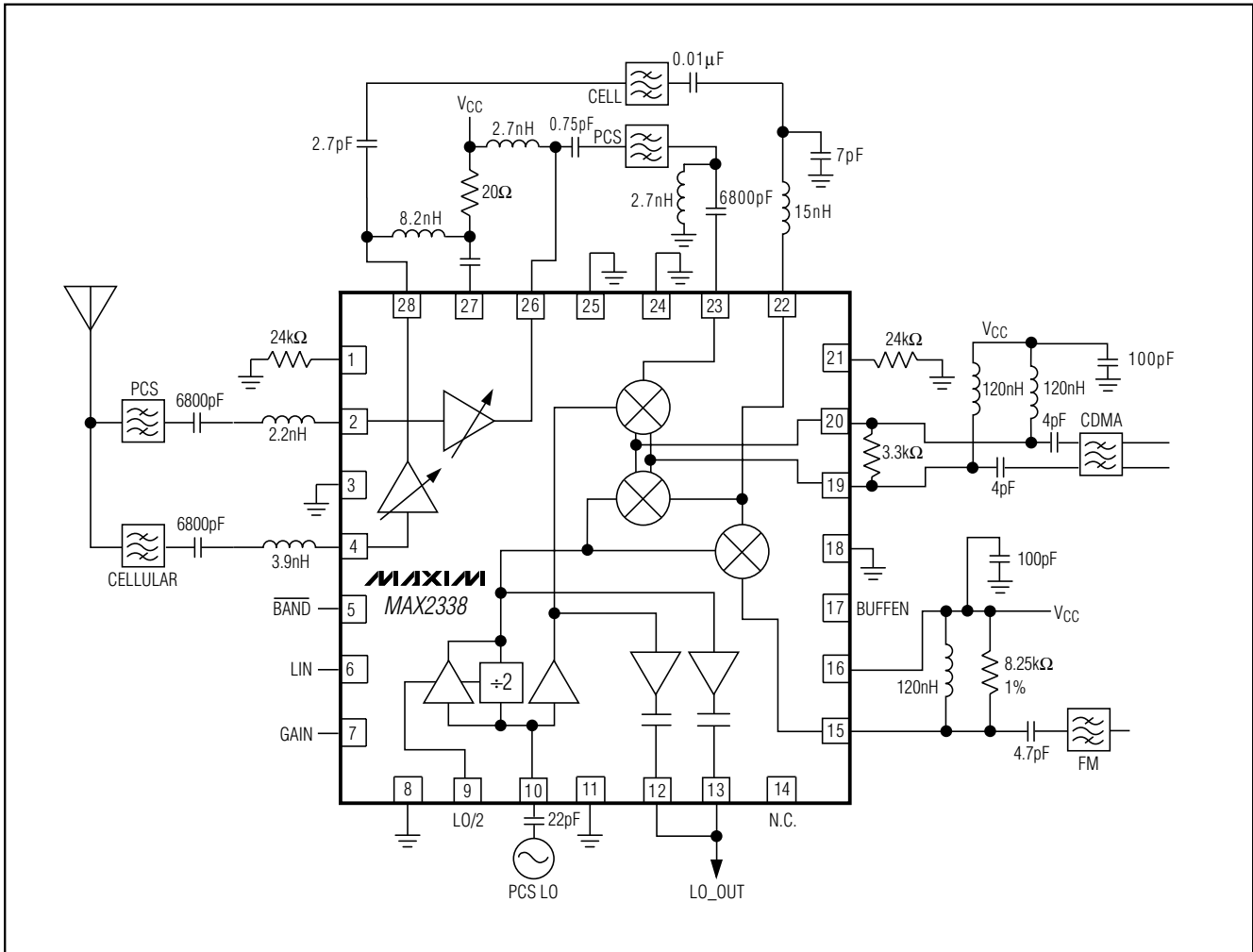

Package Information

For the latest package outline information, go to www.maxim-ic.com/packages.

Maxim cannot assume responsibility for use of any circuitry other than circuitry entirely embodied in a Maxim product. No circuit patent licenses are implied. Maxim reserves the right to change the circuitry and specifications without notice at any time.

Maxim Integrated Products, 120 San Gabriel Drive, Sunnyvale, CA 94086 408-737-7600 _____ 13