

User-friendly auto locking connector

HR34B series



Features

- User-friendly auto locking
- IP67 waterproof
- 4 and 10 pins available
- Right angled plug and crimp type available for 10 pins

HRS

HIROSE ELECTRIC CO.,LTD.

Applications

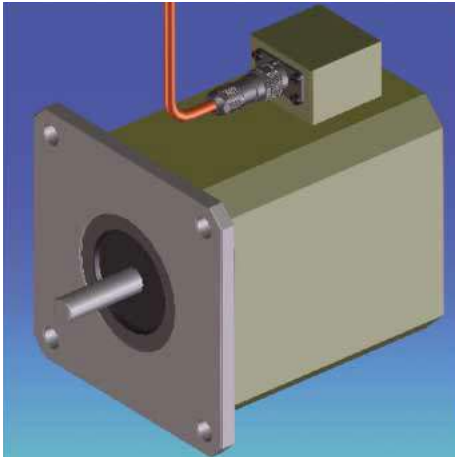

- **Servo motor**
- FA robots
- CNC machines
- Telecom equipments

Main feature

■ For mating

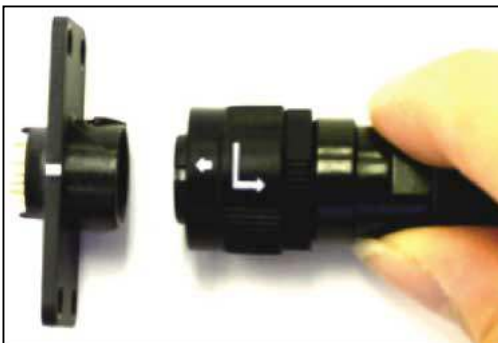

Push the shell



Lock completed



■ For unmating



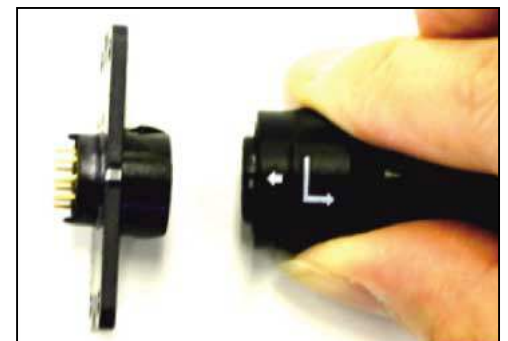

Turn the coupling sleeve and pull the plug





Original designed auto locking mechanism helps to operate easy and quick mating and unmating. It provides security against vibration, shocks and pulling on the cable.

Varieties

■ Receptacles

| 10 pin | | 4 pin |
|---|---|---|
| Rectangular | Square | Square |
| HR34B-12WR-10PD | HR34B-12WRA-10P | HR34B-12WRB-4P |
| Solder mount on PCB | Solder wire termination | Solder wire termination |
|  |  |  |

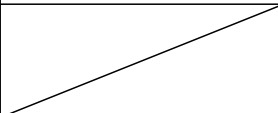
■ Plugs

| | 10 pin | | 4 pin | |
|--------------------|---|---|--|-------------------|
| | Straight | Right angled | Straight | Right angled |
| Solder termination | HR34B-12WPA-10S(ϕA) HR34B-12WPB-10S(ϕB) | HR34B-12WLPA-10S(ϕA) HR34B-12WLPB-10S(ϕB) | HR34B-12WPD-4S(ϕA) HR34B-12WPE-4S(ϕB) | Under development |
| Crimp termination | HR34B-12WPA-10SC(ϕA) HR34B-12WPB-10SC(ϕB) | HR34B-12WLPA-10SC(ϕA) HR34B-12WLPB-10SC(ϕB) |  | |
| |  |  | | |

■ Plugs for flexible conduit

| | |
|---------------------|--|
| 10 pin straight | HR34B-12WPF-10S(ϕA) HR34B-12WPG-10S(ϕB) |
| 10 pin right angled | HR34B-12WLPF-10S(ϕA) HR34B-12WLPG-10S(ϕB) |
| 4 pin straight | HR34B-12WPH-4S(ϕA) HR34B-12WPK-4S(ϕB) |

Note : ϕA is for from 5.7 to 7.3mm and ϕB is for from 6.5 to 8mm cable diameter.

Specifications

| | 10 pin | 4 pin |
|---------------------------------|-----------------------|--------------|
| Rated voltage | AC 30V, DC42 V | AC 200V |
| Dielectric withstanding voltage | AC 900V | AC 2000V |
| Insulation resistance | 1000MΩ min | |
| Rated current | 3A | 5A |
| Applicable wire | up to AWG 24 | up to AWG 20 |
| Wire termination | Soldering or crimping | Soldering |

USA:

HIROSE ELECTRIC(U.S.A.), INC.

2688 Westhills Court, Simi Valley, CA 93065-6235

Phone : 1 805 522 7958

Fax : 1 805 522 3217

<http://www.hiroseusa.com>

UNITED KINGDOM:

HIROSE ELECTRIC UK LTD.

Crownhill Business Centre 22 Vincent Avenue
Crownhill, Milton Keynes MK8 OAB

Phone : 44 1908 305400

Fax : 44 1908 305401

<http://www.hirose.co.uk>

HONG KONG:

HIROSE ELECTRIC CO., LTD.

Unit 1101, 1102A & B, Energy Plaza, 92 Granville
Road, TST East, Kowloon

Phone : 852 2803 5338

Fax : 852 2591 6560

<http://www.hirose-hongkong.com.hk>

GERMANY:

HIROSE ELECTRIC GmbH

Herzog-Carl-Strasse 4 D-73760 Ostfildern
(Scharnhauser Park)

Phone : 49 711 4560 02 1

Fax : 49 711 4560 02 299

<http://www.hirose.de>

KOREA:

HIROSE KOREA CO., LTD.

(#2NA311, Shihwa Industrial Complex), 1261-10,
Jeoungwhang-Dong, Shihung-City, Kyunggi-Do 429-450

Phone : 82 31 496 7000,7124

Fax : 82 31 496 7100

<http://www.hirose.co.kr>

TAIWAN:

HIROSE ELECTRIC TAIWAN CO., LTD.

No.28 Lane 247 Sec. 2 Yen Ping N,Rd.Taipei

Phone : 886 2 2557 7351,7352

Fax : 886 2 2552 9851

<http://www.hirose-taiwan.com.tw>

THE NETHERLANDS:

HIROSE ELECTRIC EUROPE B.V.

Beechavenue 46,1119 PV

Schiphol-Rijk

Phone : 31 20 6557490

Fax : 31 20 6557469

<http://www.hiroseurope.com>

CHINA:

HIROSE ELECTRIC TRADING(SHANGHAI) CO., LTD.

1501-02, Cross Tower Building 318 Fuzhou Road,
Huang Pu District Shanghai, 200001

Phone : 86 21 6335 2538

Fax : 86 21 6335 0767

<http://www.hirose-china.com.cn>

SINGAPORE:

HIROSE ELECTRIC CO., LTD.

10 Anson Road #26-16 International Plaza 079903

Phone : 65 6324 6113

Fax : 65 6324 6123

<http://www.hirose-singapore.com.sg>



HIROSE ELECTRIC CO.,LTD.

5-23,OSAKI 5-CHOME,SHINAGAWA-KU,TOKYO 141-8587,JAPAN

PHONE: 81-3-3491-9741, FAX: 81-3-3493-2933

<http://www.hirose.com>

<http://www.hirose-connectors.com>