

LQ057Q3DC02

TFT-LCD Module

Spec. Issue Date: April 18, 2001

No: LCY-99073B

PREPARED BY : DATE

SHARP

SPEC No. LCY-99073B

FILE No.

ISSUE : Apr. 18. 2001

PAGE : 18 pages

APPROVED BY : DATE

TFT LIQUID CRYSTAL DISPLAY GROUP
SHARP CORPORATION

DEVELOPMENT ENGINEERING DEPT. II
TFT DIVISION. I

SPECIFICATION

DEVICE SPECIFICATION FOR

TFT-LCD module

MODEL No. LQ057Q3DC02

CUSTOMER'S APPROVAL

DATA _____

BY _____

PRESENTED

BY S. Yasuda

S. YASUDA

DIVISION DUPTY GENERAL MANAGER

DEVELOPMENT ENGINEERING DEPARTMENT II

TFT DIVISION. I

TFT LIQUID CRYSTAL DISPLAY GROUP

SHARP CORPORATION

These specification sheets are the proprietary product of SHARP CORPORATION ("SHARP") and include materials protected under copyright of SHARP. Do not reproduce or cause any third party to reproduce them in any form or by any means, electronic or mechanical, for any purpose in whole or in part, without the express written permission of SHARP.

The device listed in these specification sheets was designed and manufactured for use in general electronic equipment.

In case of using the device for applications such as control and safety equipment for transportation (aircraft, trains, automobiles, etc.), rescue and security equipment and various safety related equipment which require higher reliability and safety, take into consideration that appropriate measures such as fail-safe functions and redundant system design should be taken.

Do not use the device for equipment that requires an extreme level of reliability, such as aerospace applications, telecommunication equipment (trunk lines), nuclear power control equipment and medical or other equipment for life support.

SHARP assumes no responsibility for any damage resulting from the use of the device which does not comply with the instructions and the precautions specified in these specification sheets.

Contact and consult with SHARP sales representative for any questions about this device.

1. Application

This specification applies to color TFT-LCD module, LQ057Q3DC02.

2. Overview

This module is a color active matrix LCD module incorporating amorphous silicon TFT (Thin Film Transistor). It is composed of a color TFT-LCD panel, driver ICs, control circuit, power supply circuit and a backlight unit. Graphics and texts can be displayed on a $320 \times 3 \times 240$ dots panel with 262,144 colors by supplying 18 bit data signal (6bit/color), four timing signals.

The TFT-LCD panel used for this module is a low-reflection and higher-color-saturation type. Therefore, this module is also suitable for the multimedia use. Viewing angle is 12 o'clock direction. This module is the type of wide viewing angle and high brightness 350cd/m^2 . This module has horizontal display mode and vertical display mode.

Backlight-driving DC/AC inverter is not built in this module.

3. Mechanical Specifications

Table 3-1

Parameter	Specifications	Unit
Display size	14.4 (5.7") Diagonal	cm
Active area	115.2 (H) \times 86.4(V)	mm
Pixel format	320 (H) \times 240 (V)	pixel
	(1 pixel = R + G + B dots)	—
Pixel pitch	0.360(H) \times 0.360(V)	mm
Pixel configuration	R,G,B vertical stripe	—
Display mode	Normally white	—
Unit outline dimensions	144.0(W) \times 104.6(H) \times 13.0(D)	mm
【Note3-1】		
Mass	***	g
Surface treatment	Hard-coating (3H)	—

【Note3-1】 Excluding backlight cables.

Outline dimensions is shown in Fig.1

4. Input Terminals

4-1. TFT-LCD panel driving

CNI Used connector:08-6210-033-340-800 (Kyocera Elco Corporation)

Table 4-1

Pin No.	Symbol	I/O	Function	Remark
1	GND	—	GND	
2	CK	I	Clock signal for sampling each data signal	
3	Hsync	I	Horizontal synchronous signal (Negative)	
4	Vsync	I	Vertical synchronous signal (Negative)	
5	GND	—	GND	
6	R0	I	R E D data signal (LSB)	
7	R1	I	R E D data signal	
8	R2	I	R E D data signal	
9	R3	I	R E D data signal	
10	R4	I	R E D data signal	
11	R5	I	R E D data signal (MSB)	
12	GND	—	GND	
13	G0	I	G R E E N data signal (LSB)	
14	G1	I	G R E E N data signal	
15	G2	I	G R E E N data signal	
16	G3	I	G R E E N data signal	
17	G4	I	G R E E N data signal	
18	G5	I	G R E E N data signal (MSB)	
19	GND	—	GND	
20	B0	I	B L U E data signal(LSB)	
21	B1	I	B L U E data signal	
22	B2		B L U E data signal	
23	B3	I	B L U E data signal	
24	B4	I	B L U E data signal	
25	B5	I	B L U E data signal(MSB)	
26	GND	—	GND	
27	ENAB	I	Signal to settle the horizontal display position (Positive)	【Note4-1】
28	Vcc	—	+3.3V power supply	
29	Vcc	—	+3.3V power supply	
30	R/L	I	Horizontal display mode select signal L: Normal, H: Left / Right reverse mode	【Note4-2】
31	U/D	I	Vertical display mode select signal H: Normal, L: Up / Down reverse mode	【Note4-3】
32	V/Q	I	VGA/QVGA mode select signal	
33	GND	—	GND	

【Note 4-1】The horizontal display start timing is settled in accordance with a rising timing of ENAB signal. In case ENAB is fixed "Low", the horizontal start timing is determined as described in 7-2. Don't keep ENAB "High" during operation.

【Note 4-2.3】

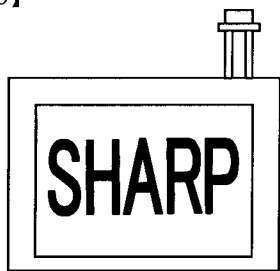

R/L=L, U/D=H

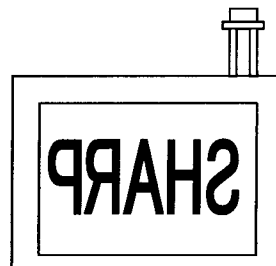

R/L=H, U/D=H



R/L=L, U/D=L

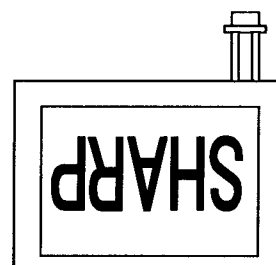

R/L=H, U/D=L

5. Backlight driving

CN2 Used connector : BHR-02(8.0)VS-1N (JST)

Corresponding connector : SM02(8.0)B-BHS-1N-TB (JST) (installed on an board.)

Table 5-1

Pin no.	symbol	function	Color of cable
1	VLOW	Power supply for lamp (Low voltage side)	White
2	NC	This is electrically opened.	—
3	VHIGH	Power supply for lamp (High voltage side)	Red

6. Absolute Maximum Ratings

Table 6-1

Parameter	Symbol	Condition	Ratings	Unit	Remark
Input voltage	V _I	T _a =25°C	-0.3 ~ +6.0	V	【Note6-1】
+3.3V supply voltage	V _{CC}	T _a =25°C	0 ~ +4.0	V	—
Storage temperature	T _{stg}	—	-30 ~ +80	°C	【Note6-2】
Operating temperature (Panel)	Topa1	—	-10 ~ +70	°C	【Note6-2.3.4】
Operating temperature (Ambient)	Topa2	—	-10 ~ +70	°C	【Note6-5】

- 【Note6-1】 CK, R0~R5, G0~G5, B0~B5, Hsync, Vsync, ENAB, R/L, U/D, V/Q
- 【Note6-2】 No parameter is allowed to exceed the range.
- 【Note6-3】 Maximum wet-bulb temperature at 39°C or less
No dew condensation.
- 【Note6-4】 Only operation is guaranteed at operating temperature. Contrast, response time, another display quality are evaluated at +25°C.
- 【Note6-5】 The ambient temperature, When backlight is on.(Reference)

7. Electrical Characteristics

7-1. TFT-LCD panel driving

Table 7-1

Ta=25°C

Parameter		Symbol	Min.	Typ.	Max.	Unit	Remark
+3.3V	Supply voltage	V _{CC}	+3.0	+3.3	+3.6	V	【Note7-1】
	Current dissipation	I _{CC}	—	(130)	(160)	mA	【Note7-2】
Permissible input ripple voltage		V _{RF}	—	—	100	mVp-p	V _{CC} =+3.3V
Input voltage (Low)		V _{IL}	0	—	0.3V _{CC}	V	【Note7-3】
Input voltage (High)		V _{IH}	0.7V _{CC}	—	+5.5	V	
Input current (Low)		I _{OL1}	—	—	10	μA	V _I =0V【Note7-3】
Input current (High)		I _{OH1}	—	—	10	μA	V _I =3.3~5.0V【Note7-4】
		I _{OH2}	—	—	100	μA	V _I =3.3~5.0V【Note7-5】

【Note7-1】

 V_{CC}-turn-on conditions

$$0 < t_1 \leq 20\text{ms}$$

$$0 < t_2 \leq 50\text{ms}$$

$$0 < t_3 \leq 1\text{s}$$

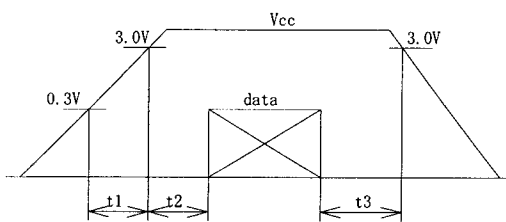
 V_{CC}-dip conditions

 V_{CC}-dip conditions should also

 follow the V_{CC}-turn-on conditions

$$t_d \leq 20\text{ms}$$

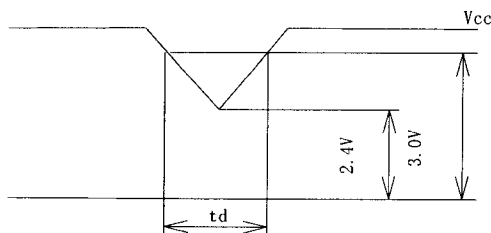

【Note7-2】Vcc=3.3V, V/Q="H"

Typical current situation

: 64-gray-bar pattern. Timing : Typical signal

Maximum current situation

: Vertical stripe pattern by GS0 and GS42 signal on every other Pixel.

(This pattern is used temporarily) Timing : Typical signal

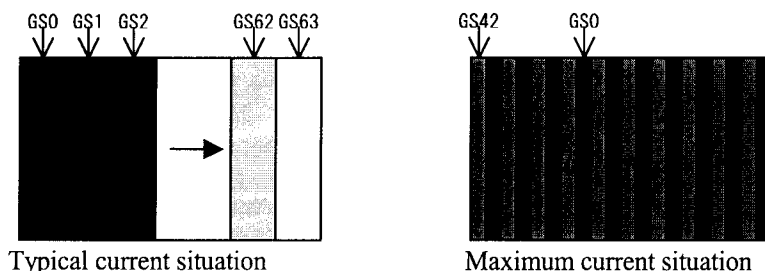

【Note7-3】 CK, R0~R5, G0~G5, B0~B5, Hsync, Vsync, ENAB, R/L, U/D, V/D

【Note7-4】 CK, R0~R5, G0~G5, B0~B5, Hsync, Vsync, R/L, U/D,

【Note7-5】 ENAB, V/D

7-2. Backlight driving

The backlight system is an edge-lighting type with single CCFT (Cold Cathode Fluorescent Tube).

The characteristics of single lamp are shown in table 7-2.

Table 7-2

Ta=25°C

Parameter	Symbol	Min.	Typ.	Max.	Unit	Remark
Lamp voltage	VL7	(620)	(690)	(760)	Vrms	IL=5.0mArms
Lamp current	IL	(4.5)	(5.0)	(5.5)	mArms	Normal operation
Lamp power consumption	WL	—	(3.5)	—	W	
Lamp frequency	fL	(*)	—	(*)	KHz	【Note7-6】
Kick-off voltage	Ta=25°C	—	—	(1350)	Vrms	Sealed is connected to GND.
	Ta=-30°C	—	—	(1470)	Vrms	

(Inverter : HIU-288 [Output Condenser 22pF] Harison Electric co.,LTD.)

【Note7-6】 Lamp frequency may produce interference with horizontal synchronous frequency, and this may cause beat on the display. Therefore lamp frequency shall be detached as much as possible from the horizontal synchronous frequency and from the harmonics of horizontal synchronous to avoid interference. In case of such an usage under the lower temperature environment, periodical lamp exchange is recommended.

8. Timing Characteristics of input signals

Timing diagrams of input signal are shown in Fig.8.

8-1. Timing characteristics

Table 8-1

Parameter Clock		Symbol	Min.	Typ.	Max.	Unit	Remark
Clock	Frequency	1/Tc	—	25.18	28.33	MHz	V/Q=H
			—	(6.3)	(7.0)	MHz	V/Q=L
	Duty ratio	TH/T	40	50	60	%	
Data	Set up time	Tds	5	—	—	ns	
	Hold time	Tdh	10	—	—	ns	
Horizontal sync. signal	Cycle	TH	30.0	31.8	—	μs	V/Q=H
			770	800	900	clock	
	TH	(50.0)	(63.6)		μs	V/Q=L	
		(360)	(400)	(450)	clock		
Pulse width	THp	2	96	200	clock		
Vertical sync. signal	Cycle	TV	515	525	560	line	V/Q=H
			(251)	(262)	(280)	line	V/Q=L
	Pulse width	TVp	2	—	34	line	
Horizontal display period		THd	320	320	320	clock	
Hsync.-Clock phase difference		THc	10	—	Tc-10	ns	
Hsync.-Vsync. phase difference		TVh	0	—	TH-THp	ns	
Vertical sync. signal start position	TVs	34	34	34	line	V/Q=H	
		(7)	(7)	(7)	Line	V/Q=L	

Note) In case of lower frequency, the deterioration of the display quality, flicker etc., may occur.

8-2. Horizontal display position

The horizontal display position is determined by ENAB signal .

Table 8-2

Parameter		symbol	Min.	Typ.	Max.	Unit	Remark
Enable signal	Set up time	Tes	5	—	Tc-10	ns	—
	Pulse width	Tep	2	320	TH-10	clock	—
Hsync.-Enable signal phase difference	THE	44	—	TH-664	clock	V/Q=H	
		(2)	—	(TH-340)		V/Q=L	

Note) When ENAB is fixed at "V/Q=Low", the display starts from the data of C52 (clock) as shown in Fig.8.

When ENAB is fixed at "V/Q=High", the display starts from the data of C104 (clock) as shown in Fig.8.

8-3. Vertical display position

The vertical display position (TVs) is fixed at 34th line (V/Q=H) and 7th line (V/Q=L).

Note) ENAB signal is independent of Vertical display position.

8-4. Input Data Signals and Display Position on the screen

Display position of input data. (H, V)

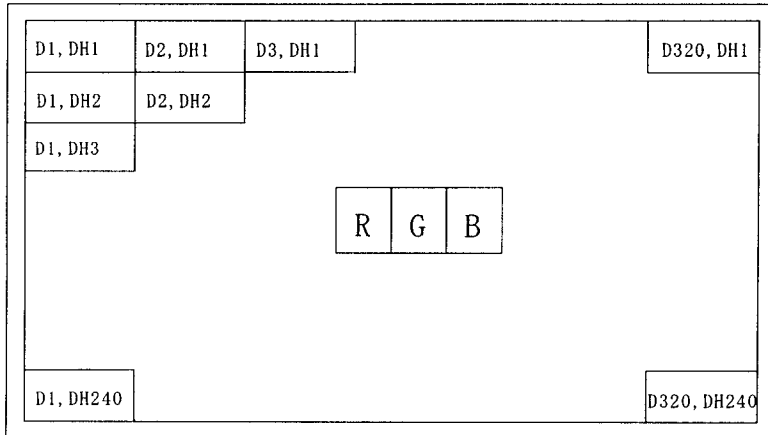

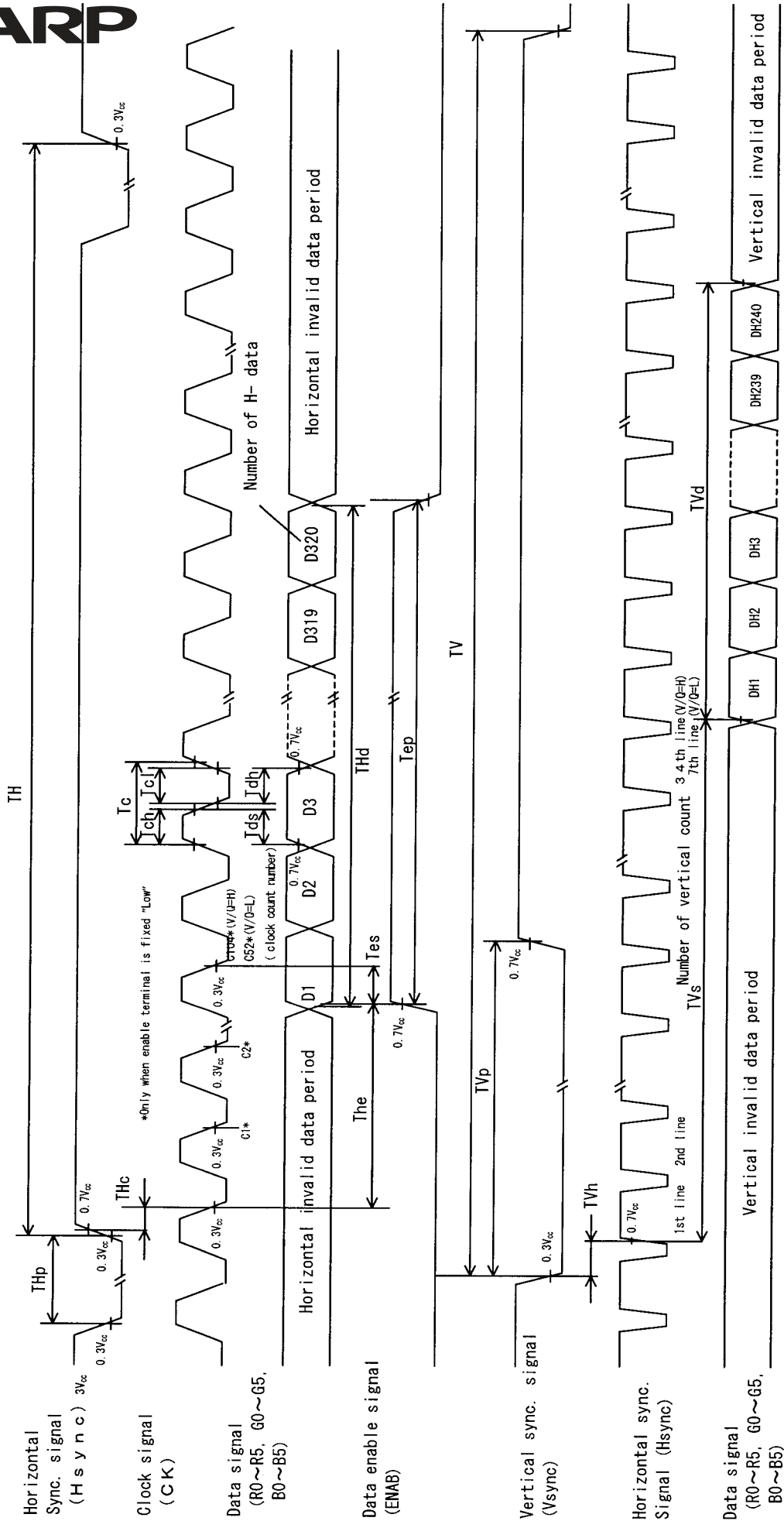

Fig.8 Input signal wave forms

9. Input signal, Basic display colors and Gray scale of each color

Table 9-1

	Colors & Gray scale	Data signal																		
		Gray Scale	R0	R1	R2	R3	R4	R5	G0	G1	G2	G3	G4	G5	B0	B1	B2	B3	B4	B5
Basic color	Black	—	0	0	0	0	0	0	0	0	0	0	0	0	0	0	0	0	0	0
	Blue	—	0	0	0	0	0	0	0	0	0	0	0	0	1	1	1	1	1	1
	Green	—	0	0	0	0	0	0	1	1	1	1	1	1	0	0	0	0	0	0
	Cyan	—	0	0	0	0	0	0	1	1	1	1	1	1	1	1	1	1	1	1
	Red	—	1	1	1	1	1	1	0	0	0	0	0	0	0	0	0	0	0	0
	Magenta	—	1	1	1	1	1	1	0	0	0	0	0	0	1	1	1	1	1	1
	Yellow	—	1	1	1	1	1	1	1	1	1	1	1	1	0	0	0	0	0	0
	White	—	1	1	1	1	1	1	1	1	1	1	1	1	1	1	1	1	1	1
Gray Scale of red	Black	GS0	0	0	0	0	0	0	0	0	0	0	0	0	0	0	0	0	0	0
	↑	GS1	1	0	0	0	0	0	0	0	0	0	0	0	0	0	0	0	0	0
	Darker	GS2	0	1	0	0	0	0	0	0	0	0	0	0	0	0	0	0	0	0
	↑	↓				↓					↓						↓			
	↓	↓				↓					↓						↓			
	Brighter	GS61	1	0	1	1	1	1	0	0	0	0	0	0	0	0	0	0	0	0
	↓	GS62	0	1	1	1	1	1	0	0	0	0	0	0	0	0	0	0	0	0
	Red	GS63	1	1	1	1	1	1	0	0	0	0	0	0	0	0	0	0	0	0
Gray Scale of green	Black	GS0	0	0	0	0	0	0	0	0	0	0	0	0	0	0	0	0	0	0
	↑	GS1	0	0	0	0	0	0	1	0	0	0	0	0	0	0	0	0	0	0
	Darker	GS2	0	0	0	0	0	0	0	1	0	0	0	0	0	0	0	0	0	0
	↑	↓				↓														
	↓	↓				↓														
	Brighter	GS61	0	0	0	0	0	0	1	0	1	1	1	1	0	0	0	0	0	0
	↓	GS62	0	0	0	0	0	0	0	1	1	1	1	1	0	0	0	0	0	0
	Green	GS63	0	0	0	0	0	0	1	1	1	1	1	1	0	0	0	0	0	0
Gray Scale of blue	Black	GS0	0	0	0	0	0	0	0	0	0	0	0	0	0	0	0	0	0	0
	↑	GS1	0	0	0	0	0	0	0	0	0	0	0	0	1	0	0	0	0	0
	Darker	GS2	0	0	0	0	0	0	0	0	0	0	0	0	0	1	0	0	0	0
	↑	↓																		
	↓	↓																		
	Brighter	GS61	0	0	0	0	0	0	0	0	0	0	0	0	1	0	1	1	1	1
	↓	GS62	0	0	0	0	0	0	0	0	0	0	0	0	0	1	1	1	1	1
	Blue	GS63	0	0	0	0	0	0	0	0	0	0	0	0	1	1	1	1	1	1

0 : Low level voltage, 1 :High level voltage

Each basic color can be displayed in 64 gray scales from 6 bit data signals. With the combination of total 18 bit data signals, the 262,144-color display can be achieved on the screen.

10. Optical Characteristics

Table 10-1

Ta=25°C, VCC=+3.3V

Parameter		Symbol	Condition	Min.	Typ.	Max.	Unit	Remark
Viewing angle range	Horizontal	$\theta 21, \theta 22$	$CR \geq 5$	(60)	(65)	—	Deg.	【Note10-1】
	Vertical	$\theta 11$		(60)	(65)	—	Deg.	
		$\theta 12$		(35)	(40)	—	Deg.	
Contrast ratio		CRmax	Best viewing angle	60	—	—		【Note10-2】
Response time	Rise	τr	$\theta = 0^\circ$	—	30	60	ms	【Note10-3】
	Decay	τd		—	50	100	ms	
Chromaticity of white		x	IL=5.0mAms	—	(0.319)	—		【Note10-4】
		y		—	(0.329)	—		
Luminance of white		Y		()	(350)	—	cd/m ²	
Lamp endurance	+25°C	—	Continuous operation	(40,000)	(50,000)	—	hour	【Note10-5】

The inverter was used to evaluate the back light unit.

The measurements were done 30 min later after switching on the backlight.

H I U - 2 8 8 [Output condenser 2 2 p F]

(Harison Electric co., LTD.)

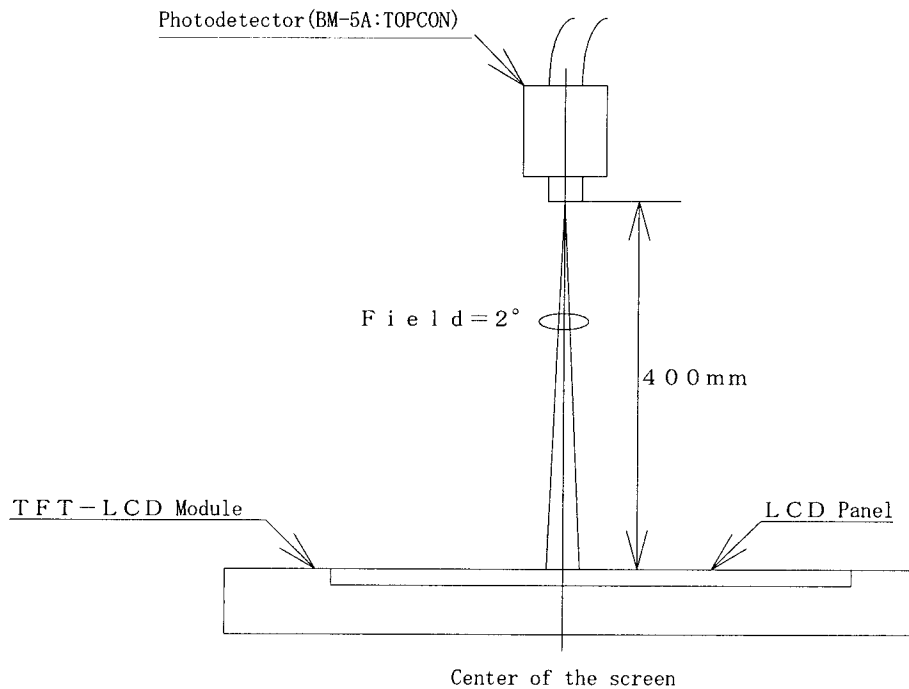

Optical characteristics measurement method

【Note 10-1】 Definition of viewing angle range

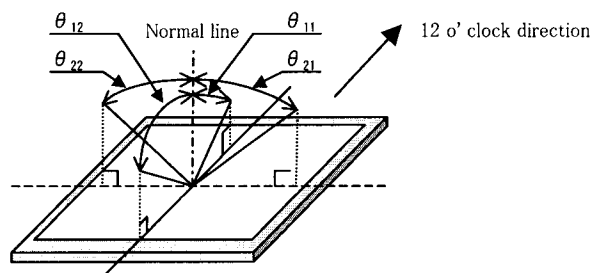

【Note 10-2】 Definition of contrast ratio

The contrast ratio is defined as follows.

$$\text{Contrast Ratio (CR)} = \frac{\text{Luminance (brightness) with all pixels white}}{\text{Luminance (brightness) with all pixels black}}$$

【Note 10-3】 Definition of response time :

The response time is defined as the following figure and shall be measured by switching the input signal for “black” and “white”.

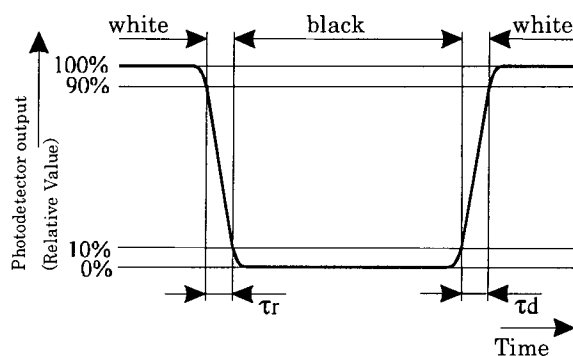

【Note 10-4】 This shall be measured at the center of the screen. The measurement was done 30 min later after switching on the backlight. (characteristic of the first stage)

Inverter drive frequency : (49) kHz

【Note 10-5】 Continuous operation time which doesn't deteriorate the brightness under 50% of the brightness at the beginning.

(Condition) IL=5.0 mArms (adjusting the brightness by current)

11. Handling Precautions

11-1. Installing the TFT-LCD module

①TFT-LCD module has holes at the corner of the reverse side of the module to install. M3 tapping screw is recommended. (torque : 0.25 ~ 0.30 N·m)

Be sure to design the cabinet so that the module can be installed without any extra stress such as warp or twist.

Be sure to design the cabinet so that the any switch doesn't press the module directly.

②Be sure to turn off the power supply when inserting or disconnecting the cable.

③Connect GND of Inverter to the metal sealed case of the module.

If the connection is not sufficient, it may cause the followings,

- a) Increasing of noise from back light.
- b) Unstable inverter output.
- c) Partial heating up.

11-2. Installation of the TFT-LCD module

Installation Precautions

①Since the front polarizer is easily damaged, pay attention to avoid rubbing with something hard or sharp.

Please use ionized nitrogen to blow particle off. When polarizer is soiled, wipe out with cloth for lenses.

②When the metal parts of TFT-LCD module (shield case) becomes dirty, wipe it out dry and soft cloth. If it cannot be removed easily, blow your breath on it and wipe it out.

③Wipe off water drop immediately. Long contact with water may cause discoloration or spots.

④Since TFT-LCD modules consist of glass and refined wires and components, it may break, crack or internal wire breaking if dropped or bumped on hard surface. Handle with care.

⑤Since CMOS LSI is used in this module, take care of static electricity and injure the human GND, when handling.

11-3. Notice for the design of products

①Design the product to keep TFT-LCD module from sodium chloride or water.

②Consider a sufficient counter measure for EMI from LCD module to application, when designing.

11-4. Others

①Liquid-crystal is deteriorated by ultraviolet rays. Do not leave it in the direct sun light and strong ultraviolet rays for many hours.

②If it is kept at a temperature below the rated storage temperature, it becomes coagulated and the panel may be broken. Also if it is isotropic liquid and does not return to its original state. Therefore, it is desirable to keep it at room temperature as much as possible.

③Kick-off voltage of back light may be required over rated voltage, due to the leakage current from the lamp cable.

- ④ When the LCD is broken, liquid-crystal may leak from the panel. Use care so that it does not enter your eyes and mouth. If it gets on hands, legs, and clothes, wash it away immediately, using soap.
- ⑤ Follow the general precautions for ordinary electronic parts.

12. Packing form

- ① Piling number of cartons : MAX. (undecided)
- ② Package quantity in one carton : pcs. (undecided)
- ③ Carton size : (W) × (D) × (H) mm (undecided)
- ④ Total mass of 1 carton filled with full modules : kg (undecided)
- ⑤ Conditions for storage
 - Temperature : 0~40°C
 - Humidity : 60%RH or less
 - Atmosphere : Harmful gas, such as acid or alkali which bites electronic components and/or wires , must not be detected.
 - Period : about 3 months
 - Opening of the package : In order to prevent the LCD module from break down by electrostatic charges, Please control the room humidity over 50%RH and open the package taking sufficient countermeasures against electrostatic charges, such as earth, etc..

13. Others

- ① As the volume of the LCD-module is adjusted correctly, do not change the adjustment. If the adjustment is changed, the LCD-module may not satisfy the specification.
- ② Do not break up the LCD-module to prevent the trouble.
- ③ Static image displayed for long time may cause residual image.
- ④ TFT-LCD drive input and output connector (33 pins Kyocera elco corporation :08-6210-033-340-800)
 - a) Adapted FPC
 - b) Holding power of the terminal : 0.9 N/pin or over
(pulling out each terminal at 25±3 mm/min)
 - c) Durability against inserting and extracting
: Double of the beginning data or less
(Difference of the contact resistance after 20 times of inserting and extracting, using adapted FPC.)

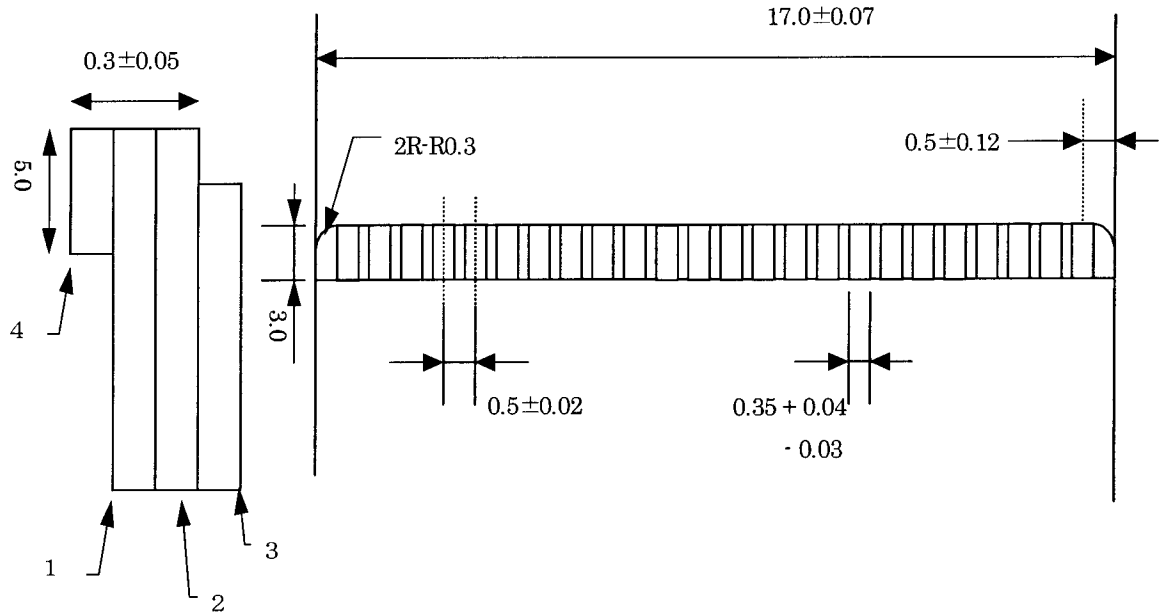

Table 13-1

Number	Name	Material
1	Base	Polyimide or the same kind of material (2 5 μ m thickness)
2	Copper layer	Thin Copper film (3 5 μ m thickness) Solder plating 2 μ m or more
3	Cover layer	Polyimide or same kind of material
4	Support board	Polyester, Polyimide or the same kind of material (1 8 8 μ m thickness)

FPC adapted to Input output connector (0 . 5 mm pitch)

14. Conditions of Reliability tests

Table 14-1

No.	Test items	Conditions
1	High temperature storage test	Ta=80°C 240h
2	Low temperature storage test	Ta=-30°C 240h
3	High temperature & high humidity operation test	Ta=40°C , 95%RH 240h (No condensation)
4	High temperature operation test	Ta=70°C 240h
5	Low temperature operation test	Ta=-10°C 240h Lamp endurance is excepted.
6	Electro static discharge test	±200V, 200pF (0Ω) 1 time for each terminal.
7	Shock test (non- operating)	Max. gravity : 490m/s ² ·6ms Direction : ±X, ±Y, ±Z 3 times for each direction. (JIS C0041)
8	Vibration test (non- operating)	Frequency : 5~57Hz/Vibration width : 0.15 mm : 58~500Hz/Acceralation: 9.8m/s ² Sweep time : 11 minutes Test period : 3 hours (1 hours in each direction of X,Y,Z)
9	Heat shock test	Ta = -30 °C ~ +80°C / 100 cycles (0.5h) (0.5h)

【Result Evaluation Criteria】

Under the display quality test conditions with normal operation state, these shall be no change, Which may affect practical display function.

(This condition is the target specification on the mass production. It may not satisfy this specification on test sample.)

【Note】The following figure shows the definition of X axis. Y axis. Z axis.

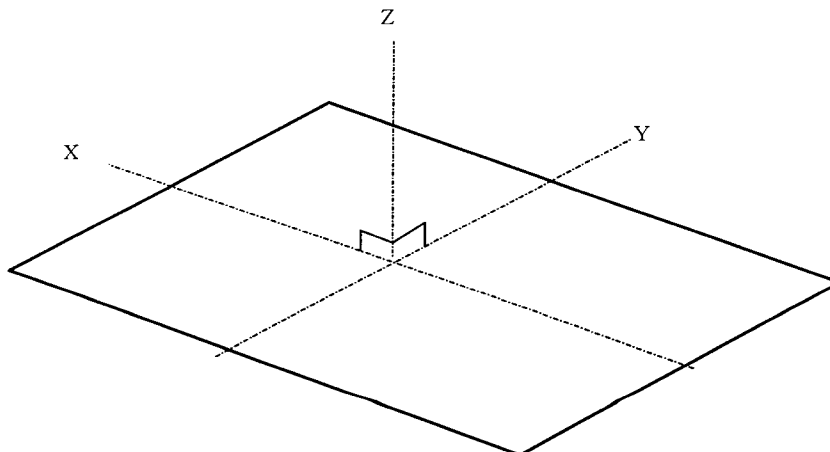

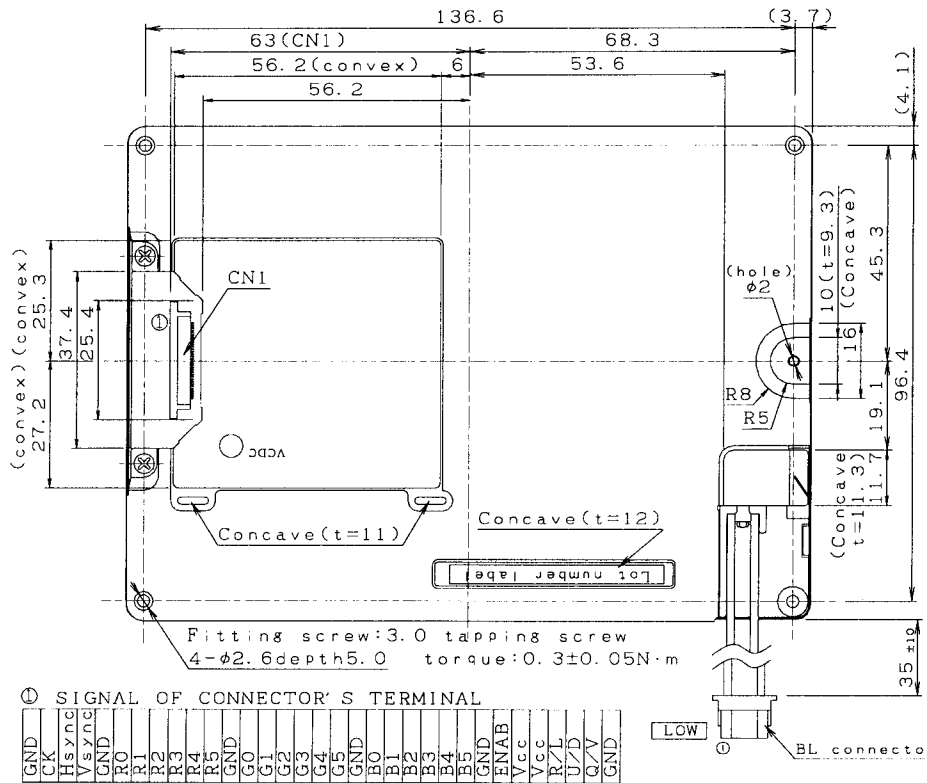
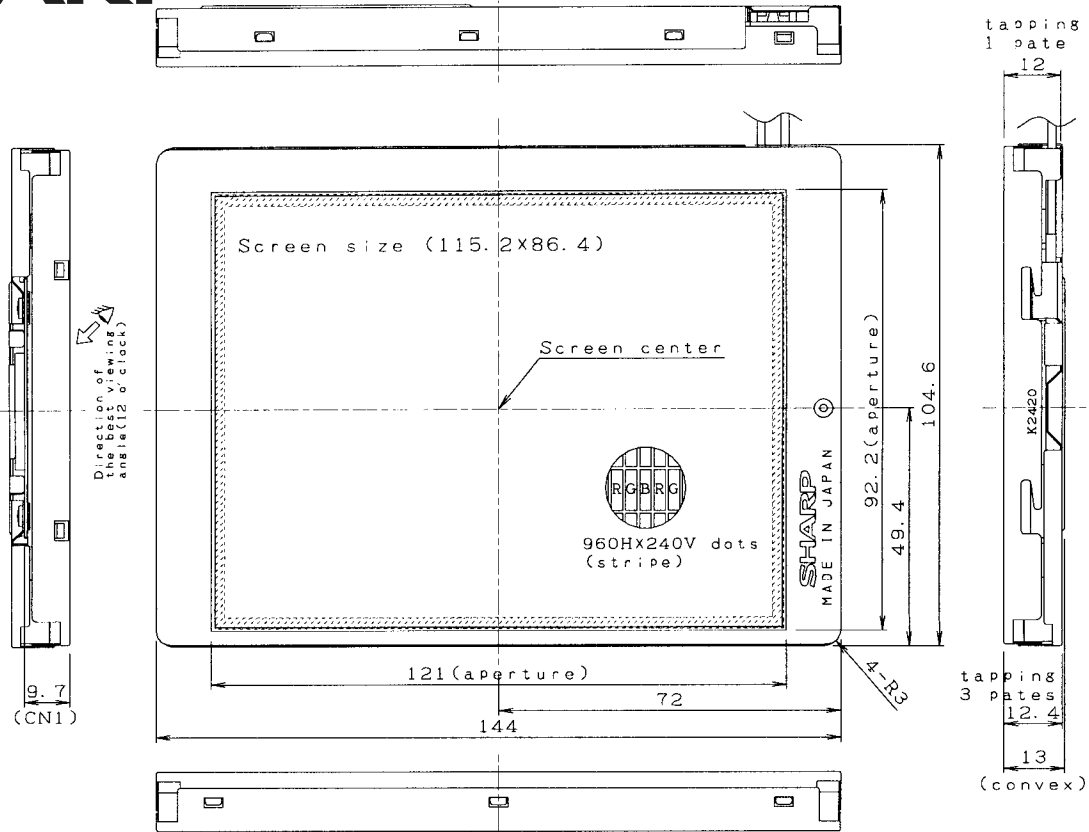

The tolerance is ±0.5 except when specified.

Consider the set design to hide the scratches and bubbles appeared on the polarizer or the frame area which is located outside of assurance area.

The tolerance width of the module excludes warp of the case.

CN1 connector: ELC0 08-6210-033-340-800

BL connector: JST 3HR-02VS-1N

Unit: mm

Outline dimensions of 5.7" TFT Model

SPECIFICATIONS ARE SUBJECT TO CHANGE WITHOUT NOTICE.

Suggested applications (if any) are for standard use; See Important Restrictions for limitations on special applications. See Limited Warranty for SHARP's product warranty. The Limited Warranty is in lieu, and exclusive of, all other warranties, express or implied. ALL EXPRESS AND IMPLIED WARRANTIES, INCLUDING THE WARRANTIES OF MERCHANTABILITY, FITNESS FOR USE AND FITNESS FOR A PARTICULAR PURPOSE, ARE SPECIFICALLY EXCLUDED. In no event will SHARP be liable, or in any way responsible, for any incidental or consequential economic or property damage.

SHARP®

NORTH AMERICA

SHARP Microelectronics of the Americas
5700 NW Pacific Rim Blvd.
Camas, WA 98607, U.S.A.
Phone: (1) 360-834-2500
Fax: (1) 360-834-8903
Fast Info: (1) 800-833-9437
www.sharpsma.com

EUROPE

SHARP Microelectronics Europe
Division of Sharp Electronics (Europe) GmbH
Sonninstrasse 3
20097 Hamburg, Germany
Phone: (49) 40-2376-2286
Fax: (49) 40-2376-2232
www.sharpsme.com

JAPAN

SHARP Corporation
Electronic Components & Devices
22-22 Nagaike-cho, Abeno-Ku
Osaka 545-8522, Japan
Phone: (81) 6-6621-1221
Fax: (81) 6117-725300/6117-725301
www.sharp-world.com

TAIWAN

SHARP Electronic Components
(Taiwan) Corporation
8F-A, No. 16, Sec. 4, Nanking E. Rd.
Taipei, Taiwan, Republic of China
Phone: (886) 2-2577-7341
Fax: (886) 2-2577-7326/2-2577-7328

SINGAPORE

SHARP Electronics (Singapore) PTE., Ltd.
438A, Alexandra Road, #05-01/02
Alexandra Technopark,
Singapore 119967
Phone: (65) 271-3566
Fax: (65) 271-3855

KOREA

SHARP Electronic Components
(Korea) Corporation
RM 501 Geosung B/D, 541
Dohwa-dong, Mapo-ku
Seoul 121-701, Korea
Phone: (82) 2-711-5813 ~ 8
Fax: (82) 2-711-5819

CHINA

SHARP Microelectronics of China
(Shanghai) Co., Ltd.
28 Xin Jin Qiao Road King Tower 16F
Pudong Shanghai, 201206 P.R. China
Phone: (86) 21-5854-7710/21-5834-6056
Fax: (86) 21-5854-4340/21-5834-6057

Head Office:

No. 360, Bashen Road,
Xin Development Bldg. 22
Waigaoqiao Free Trade Zone Shanghai
200131 P.R. China
Email: smc@china.global.sharp.co.jp

HONG KONG

SHARP-ROXY (Hong Kong) Ltd.
3rd Business Division,
17/F, Admiralty Centre, Tower 1
18 Harcourt Road, Hong Kong
Phone: (852) 28229311
Fax: (852) 28660779
www.sharp.com.hk

Shenzhen Representative Office:

Room 13B1, Tower C,
Electronics Science & Technology Building
Shen Nan Zhong Road
Shenzhen, P.R. China
Phone: (86) 755-3273731
Fax: (86) 755-3273735