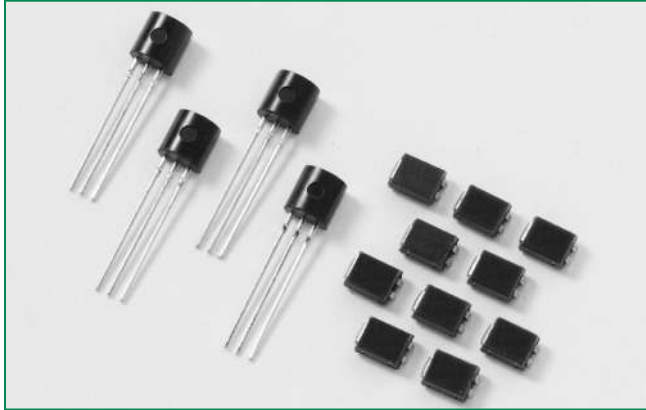


**RoHS EC103xx & SxSx Series**



**Description**

Excellent unidirectional switches for phase control applications such as heating and motor speed controls. Sensitive gate SCRs are easily triggered with microAmps of current as furnished by sense coils, proximity switches, and microprocessors.

**Features & Benefits**

- RoHS compliant
- Glass – passivated junctions
- Voltage capability up to 600 V
- Surge capability up to 20 A

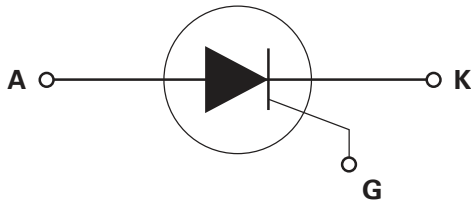
**Main Features**

Symbol	Value	Unit
$I_{T(RMS)}$	0.8	A
$V_{DRM}/V_{RRM}$	400 to 600	V
$I_{GT}$	12 to 500	$\mu A$

**Applications**

Typical applications are capacitive discharge systems for strobe lights and gas engine ignition. Also controls for power tools, home/brown goods and white goods appliances.

**Schematic Symbol**



**Absolute Maximum Ratings – Sensitive SCRs**

Symbol	Parameter	Test Conditions	Value	Unit
$I_{T(RMS)}$	RMS on-state current	$T_c = 75^\circ C$	0.8	A
$I_{T(AV)}$	Average on-state current	$T_c = 75^\circ C$	0.51	A
$I_{TSM}$	Peak non-repetitive surge current	single half cycle; $f = 50\text{Hz}$ ; $T_J(\text{initial}) = 25^\circ C$	16	A
		single half cycle; $f = 60\text{Hz}$ ; $T_J(\text{initial}) = 25^\circ C$	20	
$I^2t$	$I^2t$ Value for fusing	$t_p = 8.3 \text{ ms}$	1.6	$A^2s$
$di/dt$	Critical rate of rise of on-state current	$f = 60 \text{ Hz}$ ; $T_J = 110^\circ C$	50	$A/\mu s$
$I_{GM}$	Peak gate current	$T_J = 110^\circ C$	1	A
$P_{G(AV)}$	Average gate power dissipation	$T_J = 110^\circ C$	0.1	W
$T_{stg}$	Storage temperature range		-40 to 150	$^\circ C$
$T_J$	Operating junction temperature range		-40 to 110	$^\circ C$

0.8 A SCRs

**Electrical Characteristics ( $T_J = 25^\circ\text{C}$ , unless otherwise specified)**

Symbol	Test Conditions			Value				Unit	
				SxS1 EC103X1	SxS2 EC103X2	SxS / 2N6565 EC103X	SxS3 EC103X3		
$I_{GT}$	$V_D = 6V$ ; $R_L = 100\ \Omega$		MAX.	12	50	200	500	$\mu\text{A}$	
$V_{GT}$			MAX.	0.8				V	
dv/dt	$V_D = V_{DRM}$ ; $R_{GK} = 1\text{k}\Omega$		400V	MIN.	20	25	30	40	V/ $\mu\text{s}$
			600V		10	10	15	20	
$V_{GD}$	$V_D = V_{DRM}$ ; $R_L = 3.3\ \text{k}\Omega$ ; $T_J = 110^\circ\text{C}$		MIN.	0.2	0.25			V	
$I_H$	$I_T = 20\text{mA}$ (initial), $R_{GK} = 1\text{k}\Omega$		MAX.	5			8	mA	
$t_q$	(1)		MAX.	60		50	45	$\mu\text{s}$	
$t_{gt}$	$I_G = 2 \times I_{GT}$ ; $PW = 15\mu\text{s}$ ; $I_T = 1.6\text{A}$		TYP.	2	5	20	30	$\mu\text{s}$	

(1)  $I_T = 1\text{A}$ ;  $t_p = 50\mu\text{s}$ ; dv/dt=5V/ $\mu\text{s}$ ; di/dt=-5A/ $\mu\text{s}$

**Static Characteristics**

Symbol	Test Conditions			Value	Unit	
$V_{TM}$	$I_T = 1.2\text{A}$ ; $t_p = 380\ \mu\text{s}$			MAX.	1.7	V
$I_{DRM} / I_{RRM}$	$V_{DRM} = V_{RRM}$ $R_{GK} = 1\text{k}\Omega$		$T_J = 25^\circ\text{C}$	MAX.	1	$\mu\text{A}$
			$T_J = 100^\circ\text{C}$		50	
			$T_J = 110^\circ\text{C}$		100	

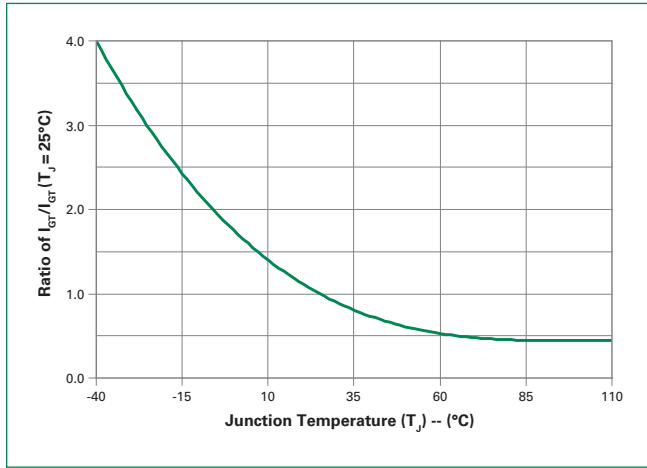
**Thermal Resistances**

Symbol	Parameter		Value	Unit	
$R_{\theta(J-C)}$	Junction to case (AC)		EC103xy/2N6565	75	$^\circ\text{C}/\text{W}$
			SxSy	60*	
$R_{\theta(J-A)}$	Junction to ambient		EC103xy/2N6565	160	$^\circ\text{C}/\text{W}$

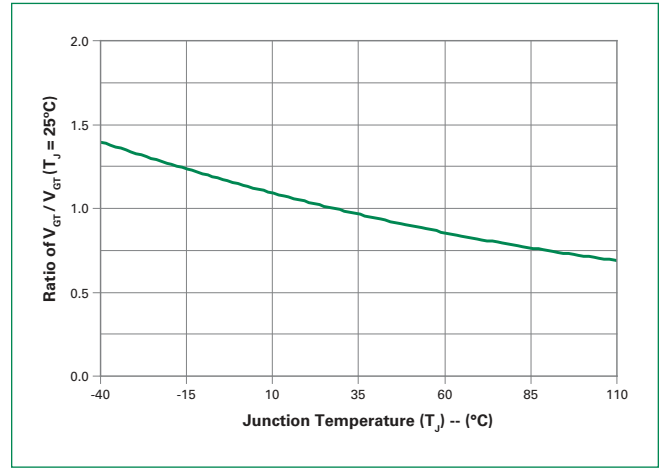
Notes: x = voltage, y = sensitivity

\* = Mounted on 1 cm<sup>2</sup> copper (two-ounce) foil surface

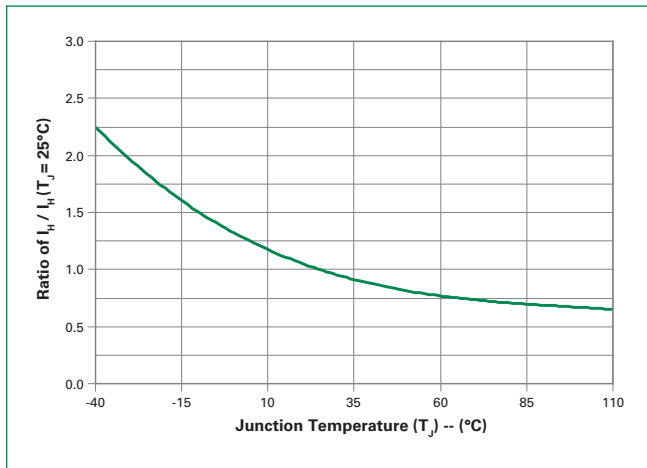
**Figure 1: Normalized DC Gate Trigger Current vs. Junction Temperature**



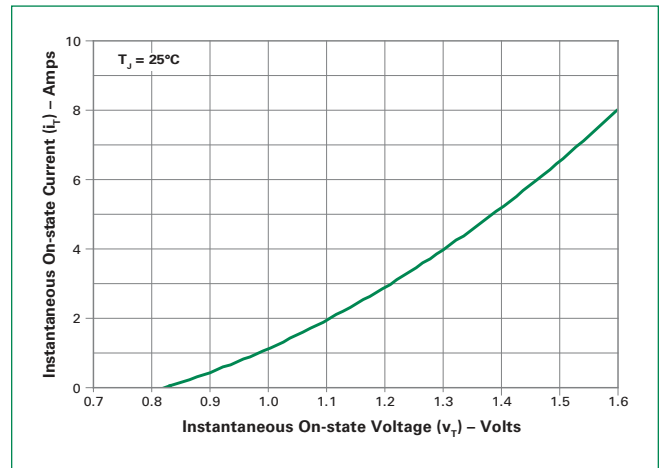
**Figure 2: Normalized DC Gate Trigger Voltage vs. Junction Temperature**



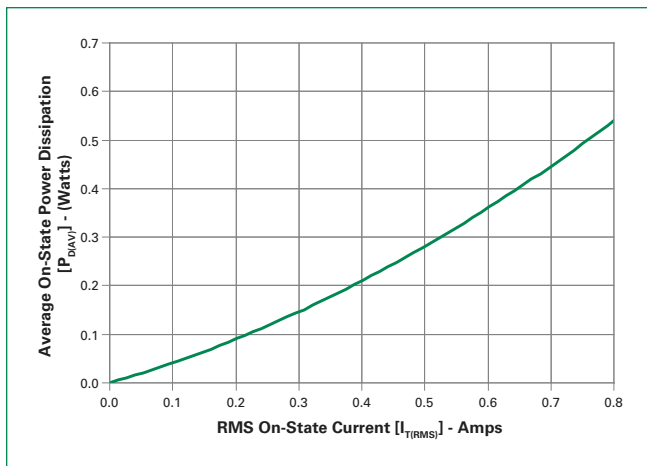
**Figure 3: Normalized DC Holding Current vs. Junction Temperature**



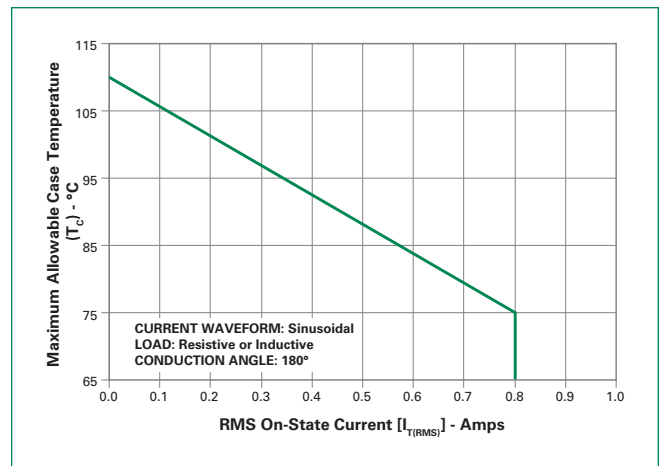
**Figure 4: On-State Current vs. On-State Voltage (Typical)**



**Figure 5: Power Dissipation (Typical) vs. RMS On-State Current**

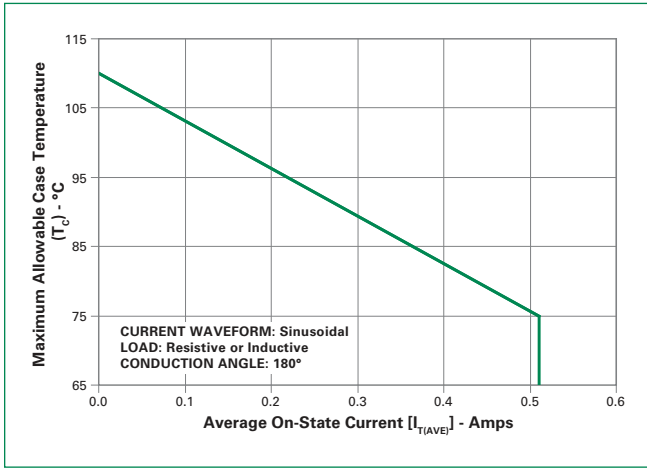


**Figure 6: Maximum Allowable Case Temperature vs. RMS On-State Current**

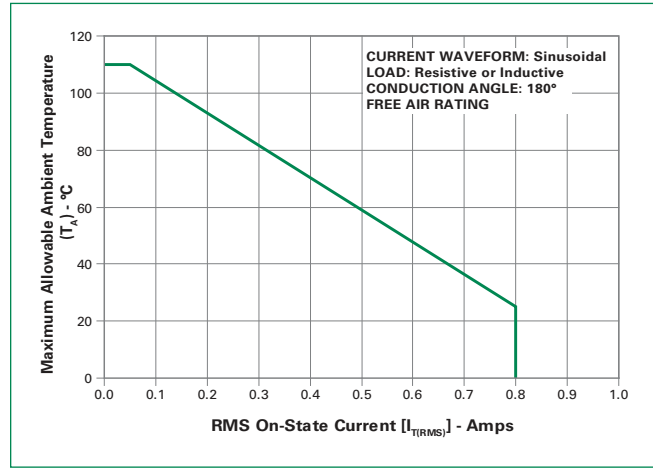


0.8 A SCRs

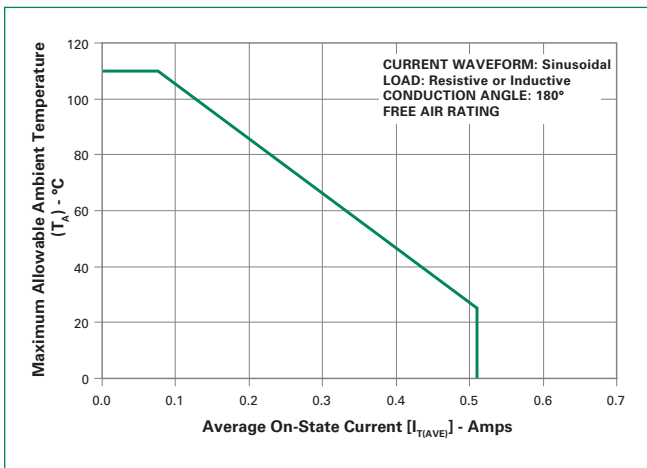
**Figure 7: Maximum Allowable Case Temperature vs. Average On-State Current**



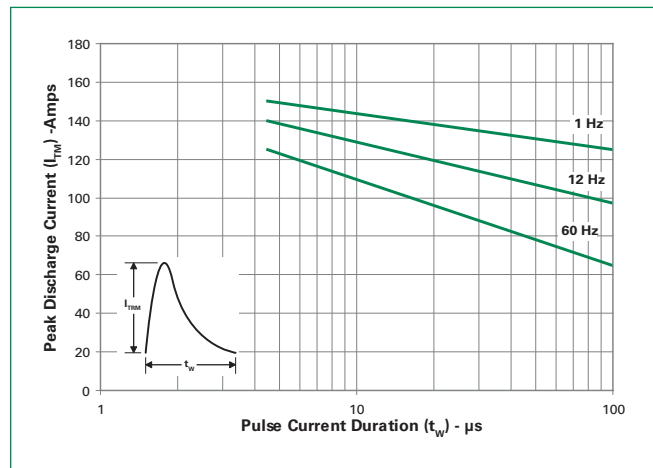
**Figure 8: Maximum Allowable Ambient Temperature vs. RMS On-State Current**



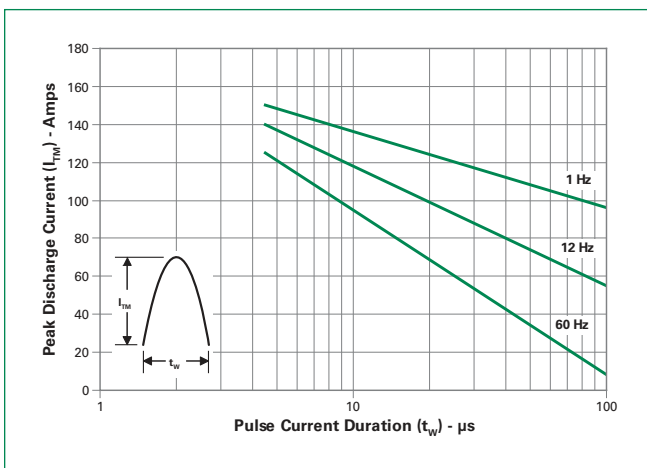
**Figure 9: Maximum Allowable Ambient Temperature vs. Average On-State Current**



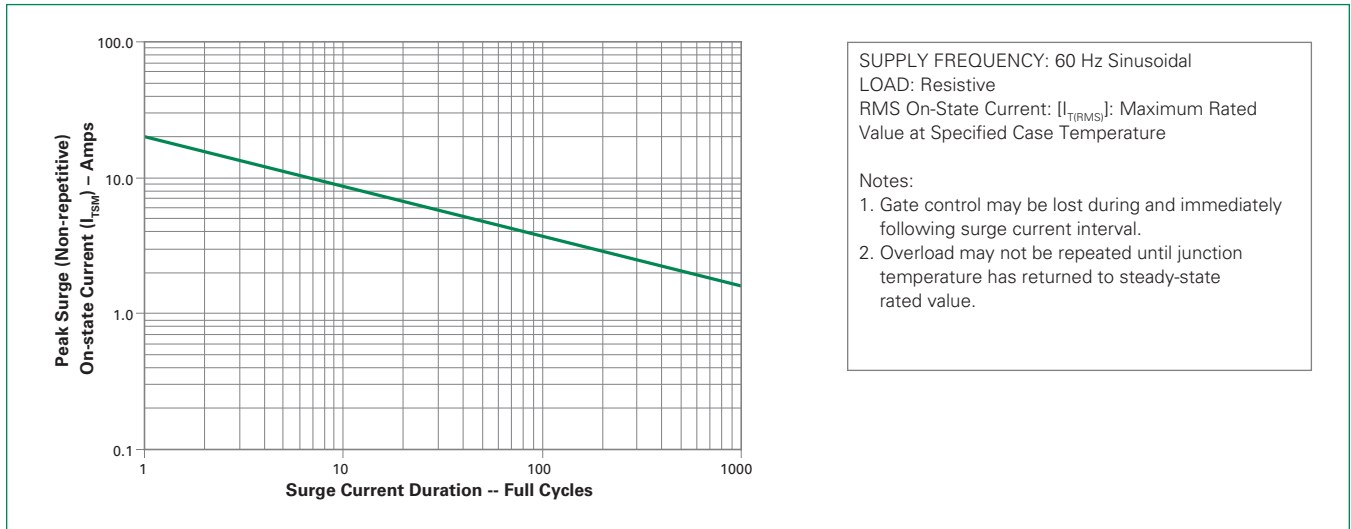
**Figure 10: Peak Capacitor Discharge Current**



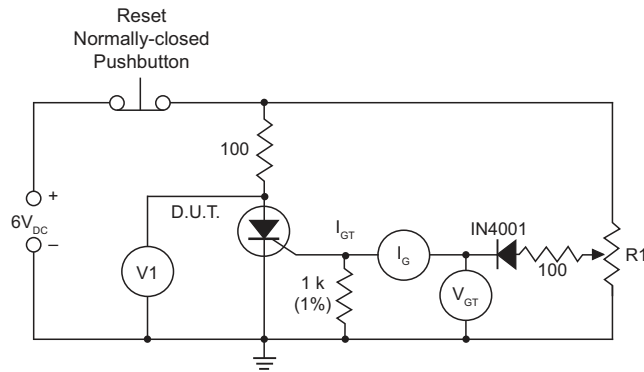
**Figure 11: Peak Repetitive Sinusoidal Pulse Current**



**Figure 12: Surge Peak On-State Current vs. Number of Cycles**



**Figure 13: Simple Test Circuit for Gate Trigger Voltage and Current**



Note: V1 — 0 V to 10 V dc meter  
V<sub>GT</sub> — 0 V to 1 V dc meter  
I<sub>G</sub> — 0 mA to 1 mA dc milliammeter  
R1 — 1 k potentiometer

To measure gate trigger voltage and current, raise gate voltage (V<sub>GT</sub>) until meter reading V1 drops from 6 V to 1 V. Gate trigger voltage is the reading on V<sub>GT</sub> just prior to V1 dropping. Gate trigger current I<sub>GT</sub> can be computed from the relationship

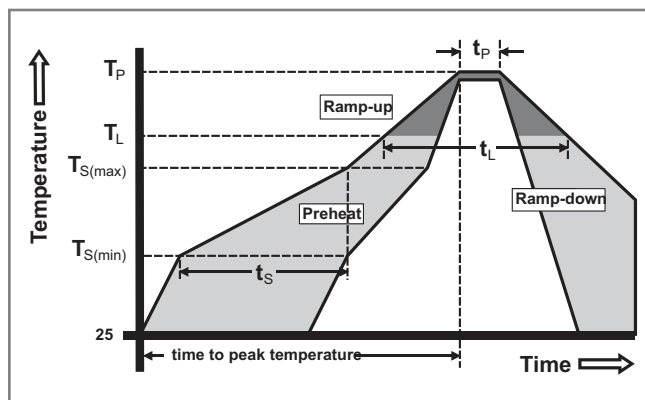
$$I_{GT} = I_G - \frac{V_{GT}}{1000} \text{ Amps}$$

where I<sub>G</sub> is reading (in amperes) on meter just prior to V1 dropping

Note: I<sub>GT</sub> may turn out to be a negative quantity (trigger current flows out from gate lead). If negative current occurs, I<sub>GT</sub> value is not a valid reading. Remove 1 k resistor and use I<sub>G</sub> as the more correct I<sub>GT</sub> value. This will occur on 12 μA gate products.

### Soldering Parameters

Reflow Condition		Pb – Free assembly
Pre Heat	- Temperature Min ( $T_{s(min)}$ )	150°C
	- Temperature Max ( $T_{s(max)}$ )	200°C
	- Time (min to max) ( $t_s$ )	60 – 180 secs
Average ramp up rate (Liquidus Temp ( $T_L$ ) to peak)		5°C/second max
$T_{s(max)}$ to $T_L$ - Ramp-up Rate		5°C/second max
Reflow	- Temperature ( $T_L$ ) (Liquidus)	217°C
	- Temperature ( $t_L$ )	60 – 150 seconds
Peak Temperature ( $T_p$ )		260 <sup>+0/-5</sup> °C
Time within 5°C of actual peak Temperature ( $t_p$ )		20 – 40 seconds
Ramp-down Rate		5°C/second max
Time 25°C to peak Temperature ( $T_p$ )		8 minutes Max.
Do not exceed		280°C



### Physical Specifications

<b>Terminal Finish</b>	100% Matte Tin-plated/Pb-free Solder Dipped
<b>Body Material</b>	UL recognized epoxy meeting flammability classification 94V-0
<b>Lead Material</b>	Copper Alloy

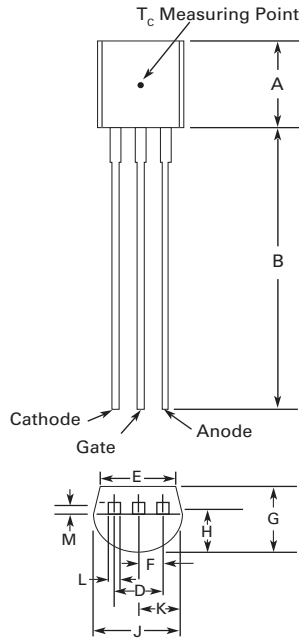
### Design Considerations

Careful selection of the correct device for the application's operating parameters and environment will go a long way toward extending the operating life of the Thyristor. Good design practice should limit the maximum continuous current through the main terminals to 75% of the device rating. Other ways to ensure long life for a power discrete semiconductor are proper heat sinking and selection of voltage ratings for worst case conditions. Overheating, overvoltage (including dv/dt), and surge currents are the main killers of semiconductors. Correct mounting, soldering, and forming of the leads also help protect against component damage.

### Environmental Specifications

Test	Specifications and Conditions
<b>AC Blocking</b>	MIL-STD-750, M-1040, Cond A Applied Peak AC voltage @ 110°C for 1008 hours
<b>Temperature Cycling</b>	MIL-STD-750, M-1051, 100 cycles; -40°C to +150°C; 15-min dwell-time
<b>Temperature/Humidity</b>	EIA / JEDEC, JESD22-A101 1008 hours; 320V - DC: 85°C; 85% rel humidity
<b>High Temp Storage</b>	MIL-STD-750, M-1031, 1008 hours; 150°C
<b>Low-Temp Storage</b>	1008 hours; -40°C
<b>Thermal Shock</b>	MIL-STD-750, M-1056 10 cycles; 0°C to 100°C; 5-min dwell-time at each temperature; 10 sec (max) transfer time between temperature
<b>Autoclave</b>	EIA / JEDEC, JESD22-A102 168 hours (121°C at 2 ATMs) and 100% R/H
<b>Resistance to Solder Heat</b>	MIL-STD-750 Method 2031
<b>Solderability</b>	ANSI/J-STD-002, category 3, Test A
<b>Lead Bend</b>	MIL-STD-750, M-2036 Cond E

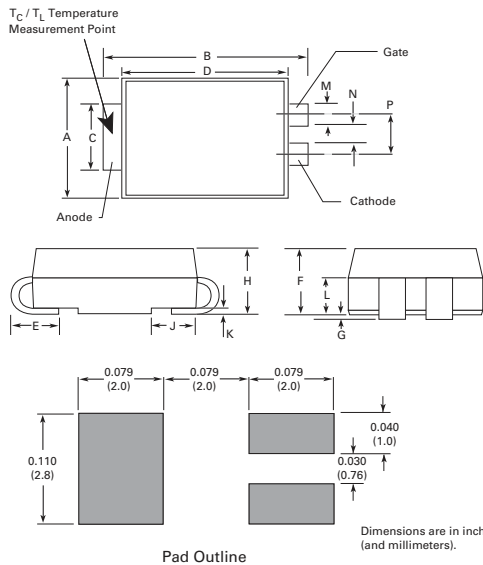
**Dimensions – TO-92 (E Package)**



Dimension	Inches		Millimeters	
	Min	Max	Min	Max
A	0.176	0.196	4.47	4.98
B	0.500	-	12.70	-
D	0.095	0.105	2.41	2.67
E	0.150	-	3.81	-
F	0.046	0.054	1.16	1.37
G	0.135	0.145	3.43	3.68
H	0.088	0.096	2.23	2.44
J	0.176	0.186	4.47	4.73
K	0.088	0.096	2.23	2.44
L	0.013	0.019	0.33	0.48
M	0.013	0.017	0.33	0.43

All leads insulated from case. Case is electrically nonconductive.

**Dimensions — Compak (C Package)**



Dimension	Inches		Millimeters	
	Min	Max	Min	Max
A	0.130	0.156	3.30	3.95
B	0.201	0.220	5.10	5.60
C	0.077	0.087	1.95	2.20
D	0.159	0.181	4.05	4.60
E	0.030	0.063	0.75	1.60
F	0.075	0.096	1.90	2.45
G	0.002	0.008	0.05	0.20
H	0.077	0.104	1.95	2.65
J	0.043	0.053	1.09	1.35
K	0.006	0.016	0.15	0.41
L	0.030	0.055	0.76	1.40
M	0.022	0.028	0.56	0.71
N	0.027	0.033	0.69	0.84
P	0.052	0.058	1.32	1.47

**0.8 A SCRs**

**Product Selector**

Part Number	Voltage				Gate Sensitivity	Type	Package
	400V	600V	800V	1000V			
EC103 x 1	X	X			12µA	Sensitive SCR	TO-92
EC103 x 2	X	X			50µA	Sensitive SCR	TO-92
EC103 x	X / 2N6565	X			200µA	Sensitive SCR	TO-92
EC103 x 3	X	X			500µA	Sensitive SCR	TO-92
S x S1	X	X			12µA	Sensitive SCR	Compak
S x S2	X	X			50µA	Sensitive SCR	Compak
S x S	X	X			200µA	Sensitive SCR	Compak
S x S3	X	X			500µA	Sensitive SCR	Compak

Note: x = Voltage

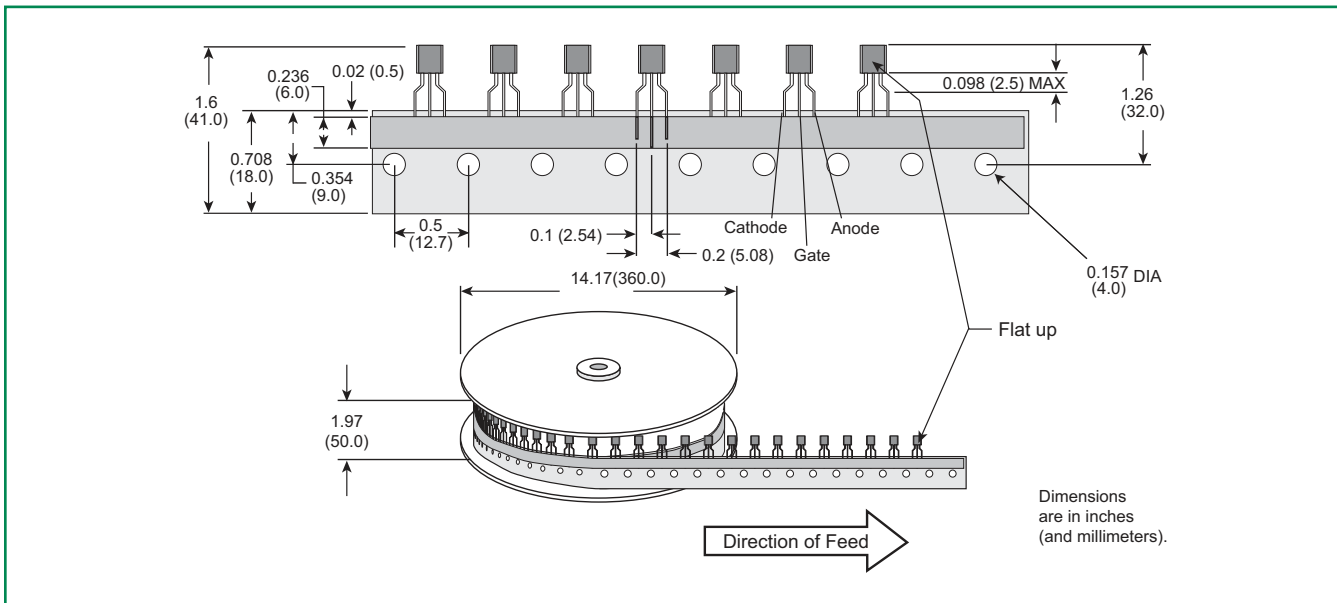
**Packing Options**

Part Number	Marking	Weight	Packing Mode	Base Quantity
EC103xy / 2N6565	EC103xy / 2N6565	0.19 g	Bulk	2000
EC103xyRP	EC103xy	0.19 g	Reel Pack	2000
EC103xyAP	EC103xy	0.19 g	Ammo Pack	2000
SxSyRP	SxSy	0.08 g	Embossed Carrier	2500

Note: x = Voltage, y = sensitivity

**TO-92 (3-lead) Reel Pack (RP) Radial Leaded Specifications**

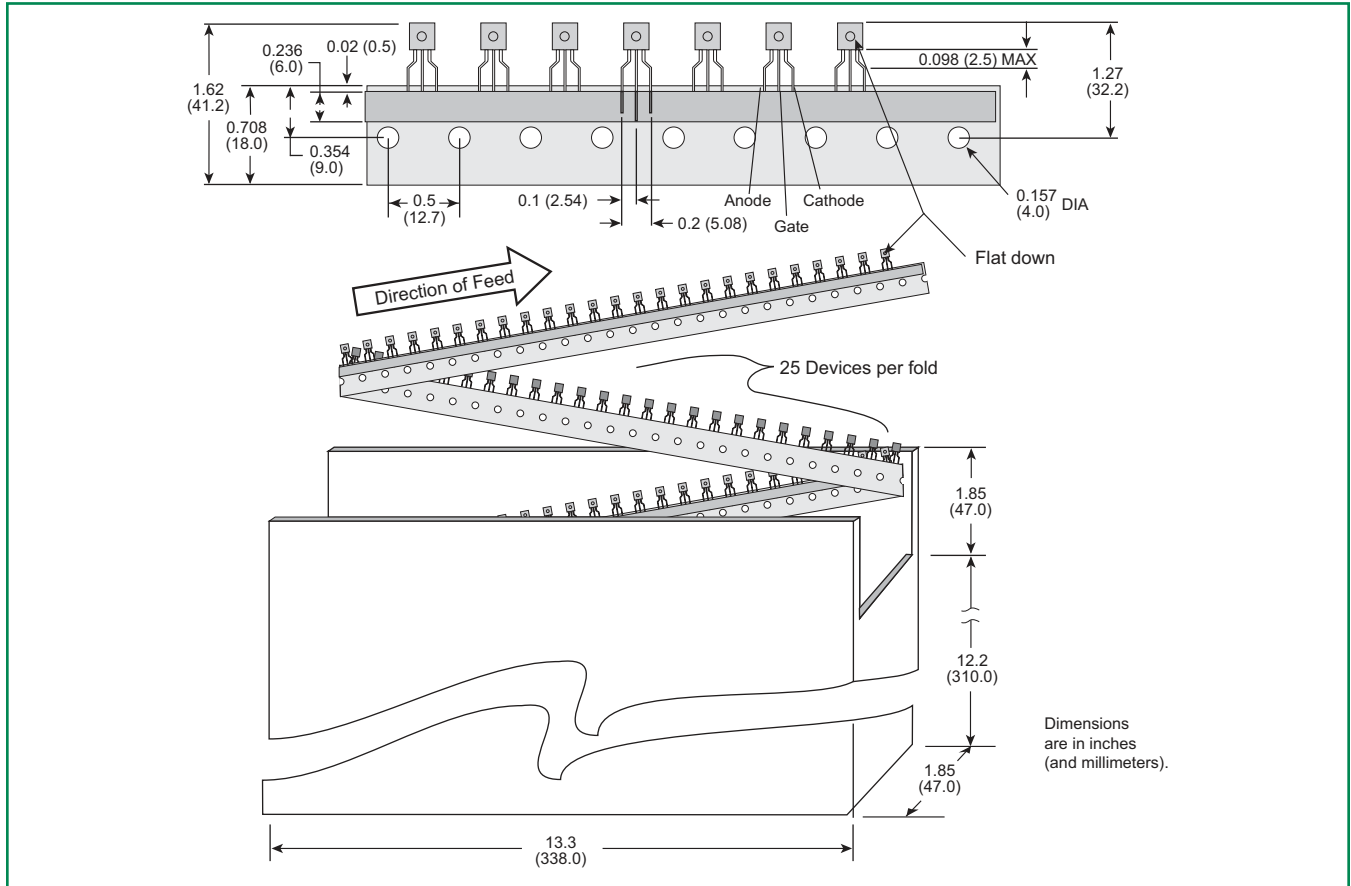
**Meets all EIA-468-B 1994 Standards**





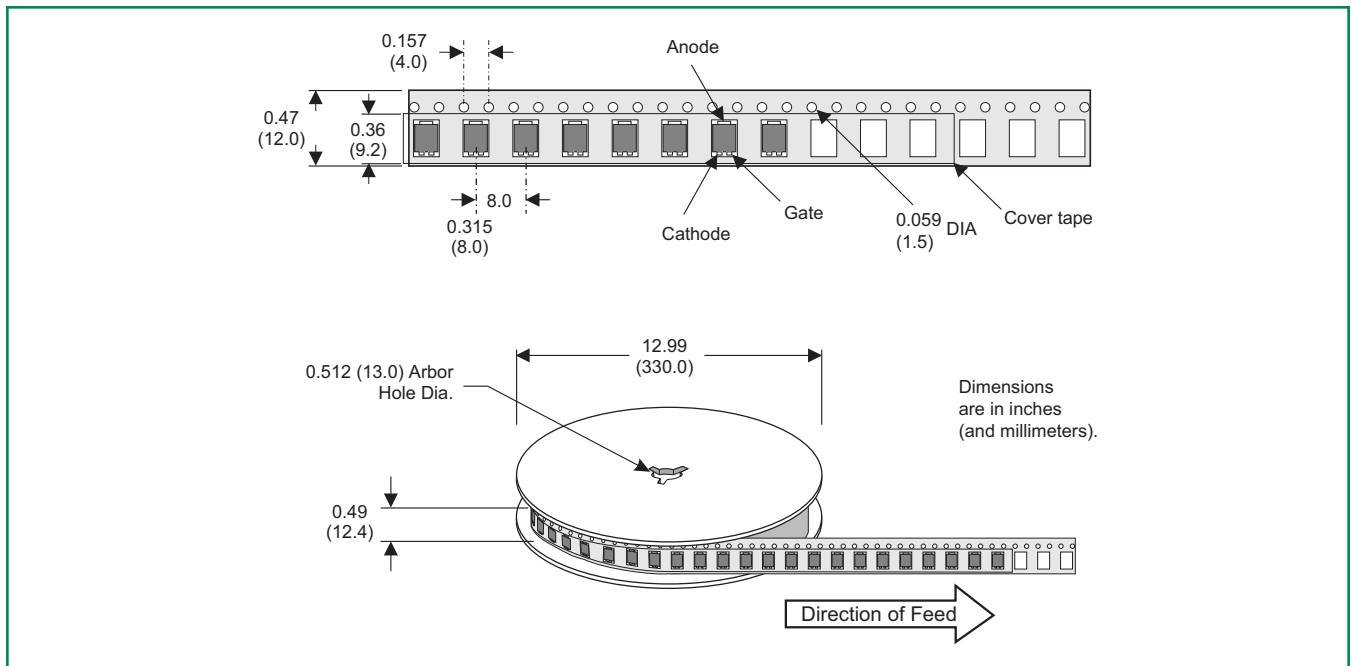
**TO-92 (3-lead) Ammo Pack (AP) Radial Leaded Specifications**

Meets all EIA-468-B 1994 Standards



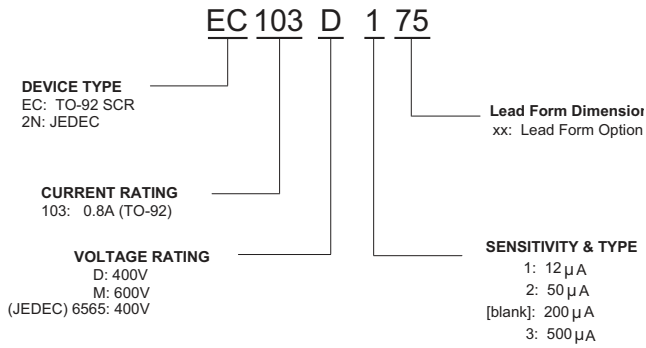
**Compak Embossed Carrier Reel Pack (RP) Specifications**

Meets all EIA-481-1 Standards



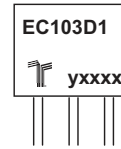
0.8 A SCRs

**Part Numbering System (TO-92)**

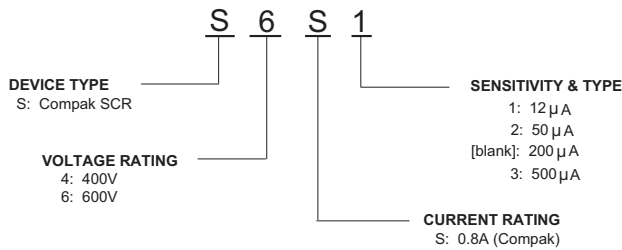


**Part Marking System**

**TO-92 (E Package)**



**Part Numbering System (Compak)**



**Part Marking System (Compak)**

**Compak (C Package)**

