

**FEATURES**

- Ultralow power: as low as 23  $\mu\text{A}$  in measurement mode and 0.1  $\mu\text{A}$  in standby mode at  $V_S = 2.5\text{ V}$  (typical)**
- Power consumption scales automatically with bandwidth**
- User-selectable resolution from 10 to 13 bits**
- 4 mg/LSB scale factor in all  $g$  ranges**
- 32-sample FIFO minimizes host processor load**
- Single tap, double tap, and free-fall detection**
- Activity/inactivity monitoring**
- Supply voltage range: 2.0 V to 3.6 V**
- I/O voltage range: 1.7 V to  $V_S$**
- SPI (3- and 4-wire) and I<sup>2</sup>C digital interfaces**
- Flexible interrupt modes mappable to either interrupt pin**
- Measurement ranges selectable via serial command**
- Bandwidth selectable via serial command**
- 10,000  $g$  shock survival**
- Pb free/RoHS compliant**
- Small and thin: 3 mm  $\times$  5 mm  $\times$  1 mm LGA package**

**ENHANCED PRODUCT FEATURES**

- Supports defense and aerospace applications (AQEC standard)**
- Extended industrial temperature range ( $-55^\circ\text{C}$  to  $+105^\circ\text{C}$ )**
- Controlled manufacturing baseline**
- One assembly/test site**
- One fabrication site**
- Enhanced product change notification**
- Qualification data available on request**

**APPLICATIONS**

- Industrial equipment**
- Aerospace equipment**

**GENERAL DESCRIPTION**

The ADXL345-EP is an extended performance version of the ADXL345, which is a small, thin, ultralow power, 3-axis accelerometer with high resolution (13-bit) measurement at up to  $\pm 16\text{ g}$ . Digital output data is formatted as 16-bit twos complement and is accessible through either a SPI (3- or 4-wire) or I<sup>2</sup>C digital interface.

The ADXL345-EP is well suited for extended temperature range industrial and aerospace equipment. It measures the static acceleration of gravity in tilt-sensing applications, as well as dynamic acceleration resulting from motion or shock. Its high resolution (3.9 mg/LSB) enables measurement of inclination changes less than  $1.0^\circ$ .

Several special sensing functions are provided. Activity and inactivity sensing detect the presence or lack of motion by comparing the acceleration on any axis with user-set thresholds. Tap sensing detects single and double taps in any direction. Free-fall sensing detects if the device is falling. These functions can be mapped individually to either of two interrupt output pins. An integrated memory management system with a 32-level first in, first out (FIFO) buffer can be used to store data to minimize host processor activity and lower overall system power consumption.

Low power modes enable intelligent motion-based power management with threshold sensing and active acceleration measurement at extremely low power dissipation.

The ADXL345-EP is supplied in a small, thin, 3 mm  $\times$  5 mm  $\times$  1 mm, 14-lead, enhanced plastic package.

**FUNCTIONAL BLOCK DIAGRAM**

Figure 1.

Rev. B

[Document Feedback](#)

Information furnished by Analog Devices is believed to be accurate and reliable. However, no responsibility is assumed by Analog Devices for its use, nor for any infringements of patents or other rights of third parties that may result from its use. Specifications subject to change without notice. No license is granted by implication or otherwise under any patent or patent rights of Analog Devices. Trademarks and registered trademarks are the property of their respective owners.

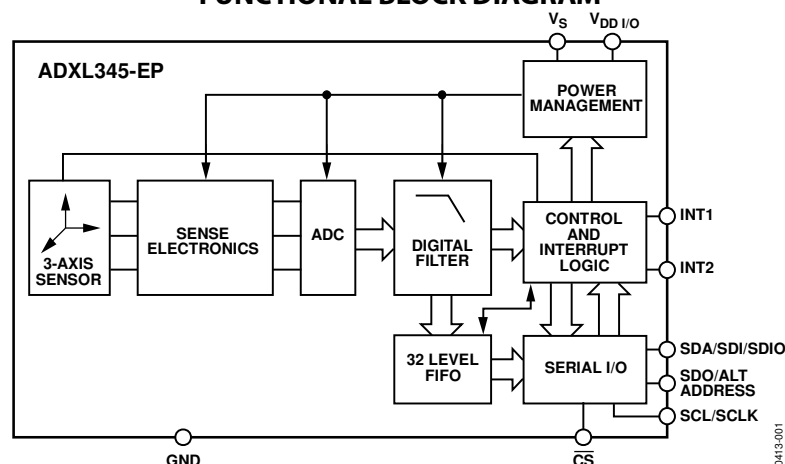
One Technology Way, P.O. Box 9106, Norwood, MA 02062-9106, U.S.A.  
Tel: 781.329.4700 ©2009–2013 Analog Devices, Inc. All rights reserved.  
[Technical Support](#) [www.analog.com](http://www.analog.com)

**TABLE OF CONTENTS**

Features .....	1	Absolute Maximum Ratings .....	5
Enhanced Product Features .....	1	Thermal Resistance .....	5
Applications.....	1	ESD Caution.....	5
General Description .....	1	Pin Configuration and Function Descriptions.....	6
Functional Block Diagram .....	1	Typical Performance Characteristics .....	7
Revision History .....	2	Outline Dimensions .....	9
Related Documents .....	2	Ordering Guide .....	9
Specifications.....	3		

**REVISION HISTORY**

**4/13—Rev. A to Rev. B**

Deleted Package Information Section, Figure 2, and Table 4, Renumbered Sequentially.....5

**2/13—Rev. 0 to Rev. A**

Changes 354 to 345 in Figure 2..... 5

**12/11—Revision 0: Initial Version**

**RELATED DOCUMENTS**

The ADXL345-EP is, by definition, an extended performance variation of the ADXL345 accelerometer. All ADXL345 datasheet descriptions are applicable and not repeated in this document, so users should refer to it for complete functionality and product description. Information and data in this ADXL345-EP subset datasheet supersede those in the standard ADXL345 datasheet.

## SPECIFICATIONS

$T_A = 25^\circ\text{C}$ ,  $V_S = 2.5\text{ V}$ ,  $V_{DD\text{I/O}} = 1.8\text{ V}$ , acceleration = 0 g,  $C_S = 10\ \mu\text{F}$  tantalum,  $C_{\text{I/O}} = 0.1\ \mu\text{F}$ , output data rate (ODR) = 800 Hz, unless otherwise noted. All minimum and maximum specifications are guaranteed. Typical specifications are not guaranteed.

Table 1.

Parameter	Test Conditions	Min	Typ <sup>1</sup>	Max	Unit
SENSOR INPUT	Each axis				
Measurement Range	User selectable		$\pm 2, \pm 4, \pm 8, \pm 16$		g
Nonlinearity	Percentage of full scale		$\pm 0.5$		%
Inter-Axis Alignment Error			$\pm 0.1$		Degrees
Cross-Axis Sensitivity <sup>2</sup>			$\pm 1$		%
OUTPUT RESOLUTION	Each axis				
All g Ranges	10-bit resolution		10		Bits
$\pm 2\text{ g}$ Range	Full resolution		10		Bits
$\pm 4\text{ g}$ Range	Full resolution		11		Bits
$\pm 8\text{ g}$ Range	Full resolution		12		Bits
$\pm 16\text{ g}$ Range	Full resolution		13		Bits
SENSITIVITY	Each axis				
Sensitivity at $X_{\text{OUT}}, Y_{\text{OUT}}, Z_{\text{OUT}}$	All g-ranges, full resolution	230	256	282	LSB/g
	$\pm 2\text{ g}$ , 10-bit resolution	230	256	282	LSB/g
	$\pm 4\text{ g}$ , 10-bit resolution	115	128	141	LSB/g
	$\pm 8\text{ g}$ , 10-bit resolution	57	64	71	LSB/g
	$\pm 16\text{ g}$ , 10-bit resolution	29	32	35	LSB/g
Sensitivity Deviation from Ideal	All g-ranges		$\pm 1.0$		%
Scale Factor at $X_{\text{OUT}}, Y_{\text{OUT}}, Z_{\text{OUT}}$	All g-ranges, full resolution	3.5	3.9	4.3	mg/LSB
	$\pm 2\text{ g}$ , 10-bit resolution	3.5	3.9	4.3	mg/LSB
	$\pm 4\text{ g}$ , 10-bit resolution	7.1	7.8	8.7	mg/LSB
	$\pm 8\text{ g}$ , 10-bit resolution	14.1	15.6	17.5	mg/LSB
	$\pm 16\text{ g}$ , 10-bit resolution	28.6	31.2	34.5	mg/LSB
Sensitivity Change Due to Temperature			$\pm 0.01$		%/ $^\circ\text{C}$
0 g OFFSET	Each axis				
0 g Output for $X_{\text{OUT}}, Y_{\text{OUT}}$		-150	0	+150	mg
0 g Output for $Z_{\text{OUT}}$		-250	0	+250	mg
0 g Output Deviation from Ideal, $X_{\text{OUT}}, Y_{\text{OUT}}$			$\pm 35$		mg
0 g Output Deviation from Ideal, $Z_{\text{OUT}}$			$\pm 40$		mg
0 g Offset vs. Temperature for X-, Y-Axes			$\pm 0.4$		mg/ $^\circ\text{C}$
0 g Offset vs. Temperature for Z-Axis			$\pm 1.2$		mg/ $^\circ\text{C}$
NOISE					
X-, Y-Axes	ODR = 100 Hz for $\pm 2\text{ g}$ , 10-bit resolution or all g-ranges, full resolution		0.75		LSB rms
Z-Axis	ODR = 100 Hz for $\pm 2\text{ g}$ , 10-bit resolution or all g-ranges, full resolution		1.1		LSB rms
OUTPUT DATA RATE AND BANDWIDTH	User selectable				
Output Data Rate (ODR) <sup>3, 4, 5</sup>		0.1		3200	Hz
SELF-TEST <sup>6</sup>					
Output Change in X-Axis		0.20		2.10	g
Output Change in Y-Axis		-2.10		-0.20	g
Output Change in Z-Axis		0.30		3.40	g
POWER SUPPLY					
Operating Voltage Range ( $V_S$ )		2.0	2.5	3.6	V
Interface Voltage Range ( $V_{DD\text{I/O}}$ )		1.7	1.8	$V_S$	V
Supply Current	ODR $\geq 100\text{ Hz}$		140		$\mu\text{A}$
	ODR $< 10\text{ Hz}$		23		$\mu\text{A}$
Standby Mode Leakage Current			0.1		$\mu\text{A}$
Turn-On and Wake-Up Time <sup>7</sup>	ODR = 3200 Hz		1.4		ms

Parameter	Test Conditions	Min	Typ <sup>1</sup>	Max	Unit
TEMPERATURE Operating Temperature Range		-55		+105	°C
WEIGHT Device Weight			30		mg

<sup>1</sup> The typical specifications shown are for at least 68% of the population of parts and are based on the worst case of mean  $\pm 1 \sigma$ , except for 0 g output and sensitivity, which represents the target value. For 0 g output and sensitivity, the deviation from the ideal describes the worst case of mean  $\pm 1 \sigma$ .

<sup>2</sup> Cross-axis sensitivity is defined as coupling between any two axes.

<sup>3</sup> Bandwidth is the -3 dB frequency and is defined as half the output data rate, bandwidth = ODR/2.

<sup>4</sup> The output format for the 3200 Hz and 1600 Hz ODRs is different from the output format for the remaining ODRs. This difference is described in the ADXL345 data sheet.

<sup>5</sup> Output data rates below 6.25 Hz exhibit additional offset shift with increased temperature, depending on selected output data rate. Refer to the ADXL345 data sheet for details.

<sup>6</sup> Self-test change is defined as the output (g) when the SELF\_TEST bit = 1 (in the DATA\_FORMAT register, Address 0x31) minus the output (g) when the SELF\_TEST bit = 0. Due to device filtering, the output reaches its final value after  $4 \times \tau$  when enabling or disabling self-test, where  $\tau = 1/(\text{data rate})$ . The part must be in normal power operation (LOW\_POWER bit = 0 in the BW\_RATE register, Address 0x2C) for self-test to operate correctly.

<sup>7</sup> Turn-on and wake-up times are determined by the user-defined bandwidth. At a 100 Hz data rate, the turn-on and wake-up times are each approximately 11.1 ms. For other data rates, the turn-on and wake-up times are each approximately  $\tau + 1.1$  in milliseconds, where  $\tau = 1/(\text{data rate})$ .

## ABSOLUTE MAXIMUM RATINGS

Table 2.

Parameter	Rating
Acceleration	
Any Axis, Unpowered	10,000 <i>g</i>
Any Axis, Powered	10,000 <i>g</i>
$V_S$	-0.3 V to +3.9 V
$V_{DDI/O}$	-0.3 V to +3.9 V
Digital Pins	-0.3 V to $V_{DDI/O} + 0.3$ V or 3.9 V, whichever is less
All Other Pins	-0.3 V to +3.9 V
Output Short-Circuit Duration (Any Pin to Ground)	Indefinite
Temperature Range	
Powered	-55°C to +105°C
Storage	-65°C to +150°C

Stresses above those listed under Absolute Maximum Ratings may cause permanent damage to the device. This is a stress rating only; functional operation of the device at these or any other conditions above those indicated in the operational section of this specification is not implied. Exposure to absolute maximum rating conditions for extended periods may affect device reliability.

## THERMAL RESISTANCE

Table 3. Package Characteristics

Package Type	$\theta_{JA}$	$\theta_{JC}$	Device Weight
14-Terminal LGA	150°C/W	85°C/W	30 mg

## ESD CAUTION



**ESD (electrostatic discharge) sensitive device.** Charged devices and circuit boards can discharge without detection. Although this product features patented or proprietary protection circuitry, damage may occur on devices subjected to high energy ESD. Therefore, proper ESD precautions should be taken to avoid performance degradation or loss of functionality.

## PIN CONFIGURATION AND FUNCTION DESCRIPTIONS

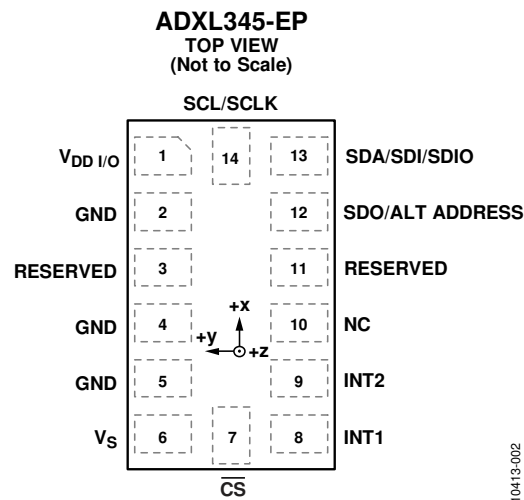

Figure 2. Pin Configuration (Top View)

Table 4. Pin Function Descriptions

Pin No.	Mnemonic	Description
1	V <sub>DD I/O</sub>	Digital Interface Supply Voltage.
2	GND	This pin must be connected to ground.
3	RESERVED	Reserved. This pin must be connected to V <sub>S</sub> or left open.
4	GND	This pin must be connected to ground.
5	GND	This pin must be connected to ground.
6	V <sub>S</sub>	Supply Voltage.
7	$\overline{\text{CS}}$	Chip Select.
8	INT1	Interrupt 1 Output.
9	INT2	Interrupt 2 Output.
10	NC	Not Internally Connected.
11	RESERVED	Reserved. This pin must be connected to ground or left open.
12	SDO/ALT ADDRESS	Serial Data Output (SPI 4-Wire)/Alternate I <sup>2</sup> C Address Select (I <sup>2</sup> C).
13	SDA/SDI/SDIO	Serial Data (I <sup>2</sup> C)/Serial Data Input (SPI 4-Wire)/Serial Data Input and Output (SPI 3-Wire).
14	SCL/SCLK	Serial Communications Clock. SCL is the clock for I <sup>2</sup> C, and SCLK is the clock for SPI.

### TYPICAL PERFORMANCE CHARACTERISTICS

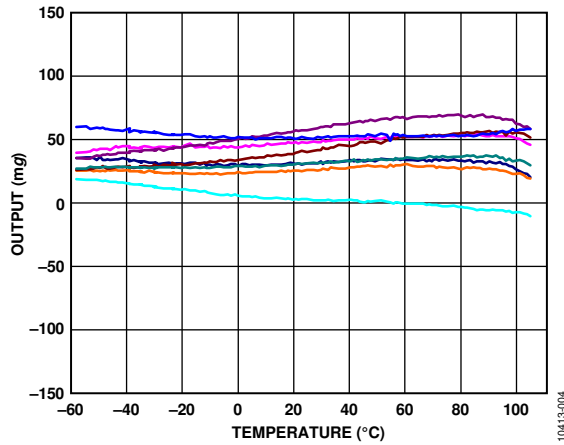

Figure 3. X-Axis Zero g Offset vs. Temperature—  
Eight Parts in Sockets,  $V_S = 3.6\text{ V}$

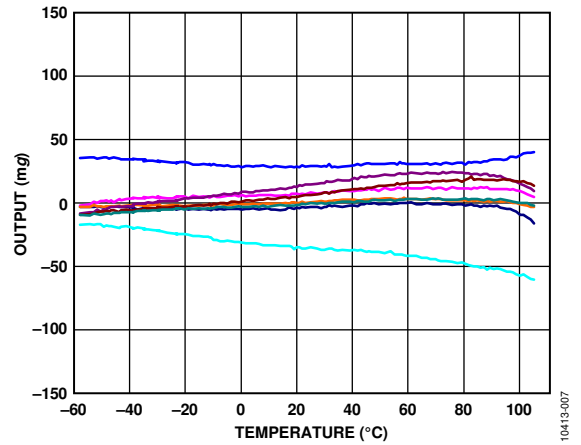

Figure 6. X-Axis Zero g Offset vs. Temperature—  
Eight Parts in Sockets,  $V_S = 2.5\text{ V}$

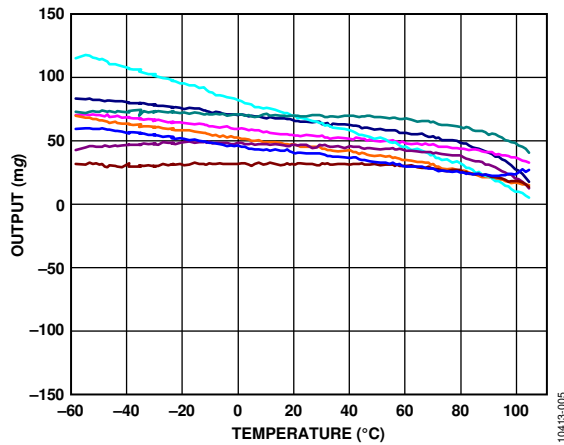

Figure 4. Y-Axis Zero g Offset vs. Temperature—  
Eight Parts in Sockets,  $V_S = V_{DD/IO} = 3.6\text{ V}$

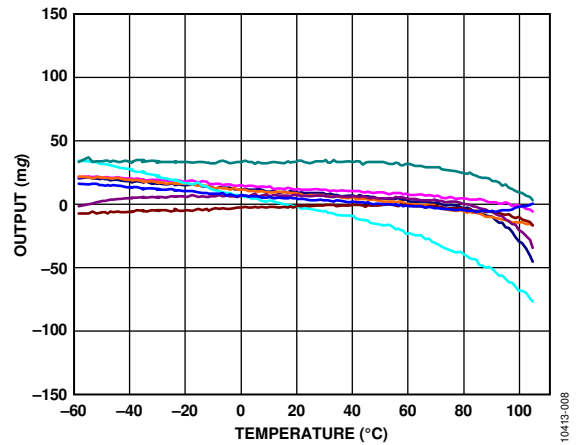

Figure 7. Y-Axis Zero g Offset vs. Temperature—  
Eight Parts Soldered to PCB,  $V_S = V_{DD/IO} = 2.5\text{ V}$

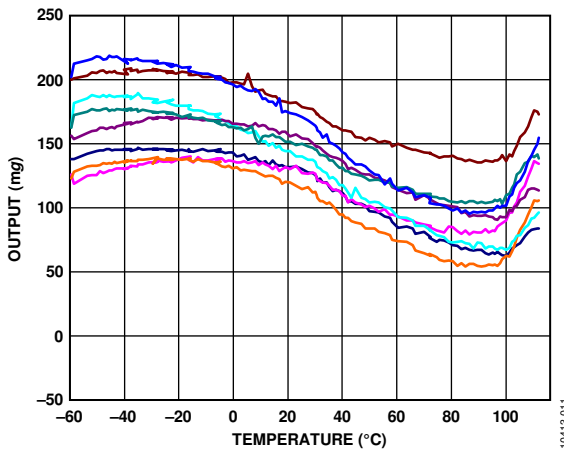

Figure 5. Z-Axis Zero g Offset vs. Temperature—  
Eight Parts in Sockets,  $V_S = V_{DD/IO} = 3.6\text{ V}$

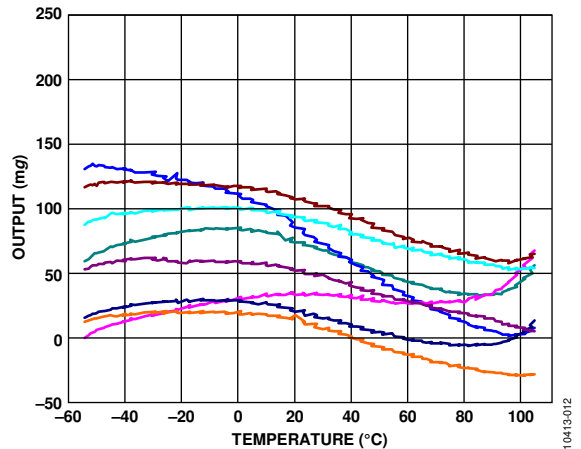

Figure 8. Z-Axis Zero g Offset vs. Temperature—  
Eight Parts Soldered to PCB,  $V_S = V_{DD/IO} = 2.5\text{ V}$

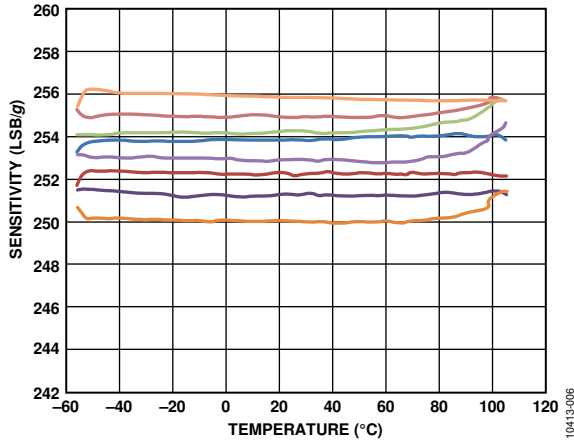

Figure 9. X-Axis Sensitivity vs. Temperature—  
Eight Parts in Sockets,  $V_S = V_{DDIO} = 2.5\text{ V}$

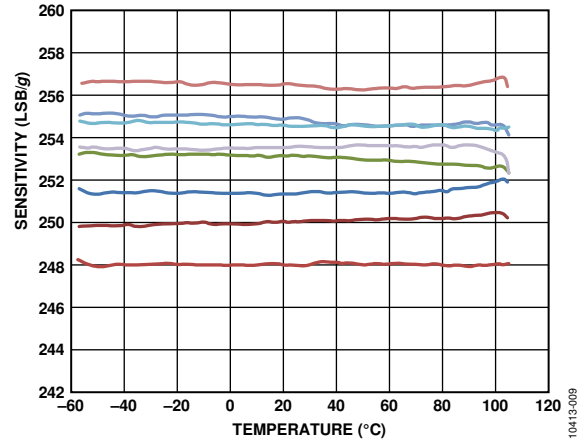

Figure 11. Y-Axis Sensitivity vs. Temperature—  
Eight Parts in Sockets,  $V_S = V_{DDIO} = 2.5\text{ V}$

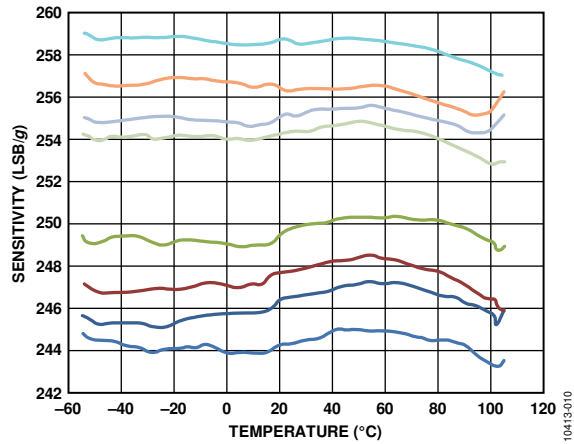

Figure 10. Z-Axis Sensitivity vs. Temperature—  
Eight Parts in Sockets,  $V_S = V_{DDIO} = 2.5\text{ V}$



# OUTLINE DIMENSIONS

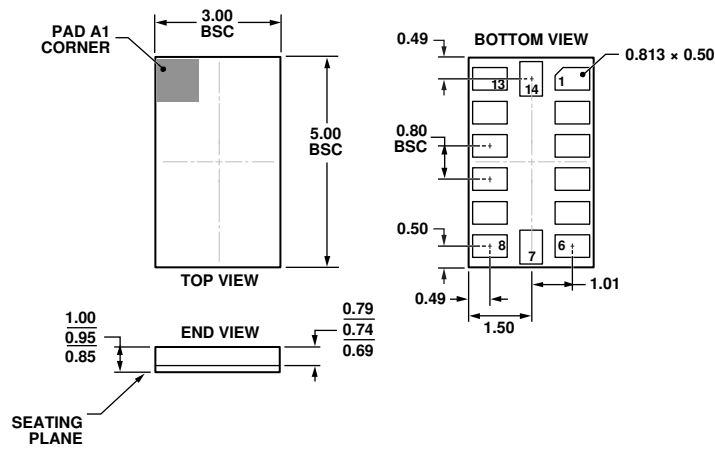

Figure 12. 14-Terminal Land Grid Array [LGA]  
(CC-14-1)  
Solder Terminations Finish Is Au over Ni  
Dimensions shown in millimeters

03-16-2010-A

## ORDERING GUIDE

Model <sup>1</sup>	Measurement Range (g)	Specified Voltage (V)	Temperature Range	Package Description	Package Option
ADXL345TCCZ-EP	±2, ±4, ±8, ±16	2.5	-55°C to +105°C	14-Terminal Land Grid Array [LGA]	CC-14-1
ADXL345TCCZ-EP-RL7	±2, ±4, ±8, ±16	2.5	-55°C to +105°C	14-Terminal Land Grid Array [LGA]	CC-14-1
ADXL345TCCZ-EP-RL	±2, ±4, ±8, ±16	2.5	-55°C to +105°C	14-Terminal Land Grid Array [LGA]	CC-14-1

<sup>1</sup> Z = RoHS Compliant Part.

**NOTES**

**NOTES**

**NOTES**

Analog Devices offers specific products designated for automotive applications; please consult your local Analog Devices sales representative for details. Standard products sold by Analog Devices are not designed, intended, or approved for use in life support, implantable medical devices, transportation, nuclear, safety, or other equipment where malfunction of the product can reasonably be expected to result in personal injury, death, severe property damage, or severe environmental harm. Buyer uses or sells standard products for use in the above critical applications at Buyer's own risk and Buyer agrees to defend, indemnify, and hold harmless Analog Devices from any and all damages, claims, suits, or expenses resulting from such unintended use.

©2009–2013 Analog Devices, Inc. All rights reserved. Trademarks and registered trademarks are the property of their respective owners.  
D10413-0-4/13(B)



[www.analog.com](http://www.analog.com)