

### Applications

- Telecommunications
- Data communications
- Wireless communications
- Servers, workstations

### Benefits

- Cost-effective, single board design with optional attached baseplate for cold plate cooling applications and enhanced power capability.
- High efficiency – no heat sink required

### Description

The HBC48T25120 power module is an open frame half-brick DC-DC converter providing a regulated and isolated output voltage of 12.0 VDC with an output current up to 25 A suitable for today's Distributed Power Architecture applications. It offers outstanding thermal performance in high temperature environments.

This performance is accomplished through the use of patented/patent-pending circuits, packaging, and processing techniques to achieve ultra-high efficiency, excellent thermal management, and a low mechanical profile.

This low-body profile minimizes impedance to system airflow, thereby enhancing cooling for both upstream and downstream devices. For extended cooling purposes, a baseplate option is available. Attaching a heat sink or cold plate further enhances the unit's capability. The use of 100% automation for assembly, coupled with advanced electronic circuits and thermal design, results in a product with extremely high reliability.

Operating from a 36-75 V input, the HBC48T25120 converter provides an output that can be trimmed from -20% to +10% of the nominal output voltage, thereby providing outstanding design flexibility.

### Features

- RoHS lead-free solder and lead-solder-exempted products are available
- Delivers up to 25 A of output (13.5 A @ 70 °C, 200 LFM)
- Industry-standard half-brick pinout
- Optional baseplate attachment
- On-board input differential LC-filter
- Startup into pre-biased load
- No minimum load required
- Dimensions: 2.40" x 2.28" x 0.50" (61.0 mm x 57.9 mm x 12.7 mm)
- Meets Basic Insulation requirements of EN60950
- Withstands 100 V input transient for 100 ms
- Fixed frequency operation
- Remote output voltage sense
- Fully protected with automatic recovery
- Positive or negative logic ON/OFF option
- Output voltage trim range: +10%/-20% with industry-standard trim equations
- High reliability: MTBF approx. 8.7 million hours, calculated per Telcordia TR-332, Method I Case 1
- Recognized to UL60950-1/CSA 22.2 No. 60950-1, and TUV approved to IEC\_EN60950-1
- Designed to meet Class B conducted emissions per FCC and EN55022 when used with external filter
- All materials meet UL94, V-0 flammability rating

### Electrical Specifications

Conditions:  $T_A = 25\text{ }^\circ\text{C}$ , Airflow = 300 LFM (1.5 m/s),  $V_{in} = 48\text{ VDC}$ , unless otherwise specified.

Parameter	Notes	Min	Typ	Max	Units
<b>Absolute Maximum Ratings</b>					
Input Voltage	Continuous Transient (100 msec)	0		75 100	VDC VDC
Operating Ambient Temperature		-40		85	$^\circ\text{C}$
Operating Temperature	Component (Tc) Baseplate (Tb)	-40 -40		125 110	$^\circ\text{C}$ $^\circ\text{C}$
Storage Temperature		-55		125	$^\circ\text{C}$
<b>Isolation Characteristics</b>					
Input to Output Isolation		1500			VDC
Input to Case Isolation		1500			VDC
Output to Case Isolation		1500			VDC
Isolation Capacitance			2.5		nF
Isolation Resistance		10			M $\Omega$
<b>Feature Characteristics</b>					
Switching Frequency			360		kHz
Output Voltage Trim Range <sup>1</sup>	Industry-std. equations	-20		+10	%
Remote Sense Compensation <sup>1</sup>	Percent of $V_{OUT(NOM)}$			+10	%
Output Overvoltage Protection	Latching	117	122	127	%
Overtemperature Shutdown	Non-latching		140 125		$^\circ\text{C}$ $^\circ\text{C}$
Auto-Restart Period	Applies to all protection features		200		ms
Turn-On Time from $V_{in}$	Time from UVLO to $V_o=90\%V_o\text{-nom}$		50		ms
Turn-On Time from enable	Time from Enable to $V_o=90\%V_o\text{-nom}$		4		ms
ON/OFF Control (Positive Logic)					
Converter Off (logic low)		-20		0.8	VDC
Converter On (logic high)		2.4		20	VDC
ON/OFF Control (Negative Logic)					
Converter Off (logic high)		2.4		20	VDC
Converter On (logic low)		-20		0.8	VDC

### Electrical Specifications (continued)

Conditions:  $T_A = 25\text{ }^\circ\text{C}$ , Airflow = 300 LFM (1.5 m/s),  $V_{in} = 48\text{ VDC}$ , unless otherwise specified.

Parameter	Notes	Min	Typ	Max	Units
<b>Input Characteristics</b>					
Operating Input Voltage Range		36	48	75	VDC
Input Under Voltage Lockout	Non-latching				
Turn-on Threshold		33	34	35	VDC
Turn-off Threshold		31	32	33	VDC
Input Voltage Transient	100 ms			100	VDC
Maximum Input Current	12 VDC Out @ 25 ADC, $V_{in} = 36\text{ VDC}$			10	ADC
Input Stand-by Current	$V_{in} = 48\text{ V}$ , converter disabled		3		mADC
Input No Load Current (0 load on the output)	$V_{in} = 48\text{ V}$ , converter enabled		75		mADC
Input Reflected-Ripple Current	25 MHz bandwidth		20		mA <sub>PK-PK</sub>
Input Voltage Ripple Rejection	120 Hz		65		dB
<b>Output Characteristics</b>					
Output Voltage Set Point (no load)		11.88	12.00	12.12	VDC
Output Regulation					
Over Line			±4	±10	mV
Over Load			±4	±10	mV
Output Voltage Range	Over line, load and temperature <sup>2</sup>	11.76		12.24	VDC
Output Ripple and Noise – 25 MHz bandwidth	Full load, $C_o = 10\text{ }\mu\text{F}$ (tant.) + $1\text{ }\mu\text{F}$ (cer.)		75	200	mV <sub>PK-PK</sub>
External Load Capacitance	Plus full load (resistive)			15,000	$\mu\text{F}$
Output Current Range		0		25	ADC
Current Limit Inception	Non-latching	27.5	30	33.5	ADC
Peak Short-Circuit Current	Non-latching, Short = $10\text{ m}\Omega$		28		A
RMS Short-Circuit Current	Non-latching		5		A <sub>RMS</sub>
<b>Dynamic Response</b>					
Load Change 50%-75%-50%, $di/dt = 0.1\text{ A}/\mu\text{s}$	$C_o = 1\text{ }\mu\text{F}$ (ceramic)		50		mV
$di/dt = 1\text{ A}/\mu\text{s}$	$C_o = 15,000\text{ }\mu\text{F}$ (OSCON)		120		mV
Settling Time to 1%			30		$\mu\text{s}$
<b>Efficiency</b>					
100% Load			93		%
50% Load			95		%

Additional Notes:

<sup>1</sup>  $V_{out}$  can be increased up to 10% via the sense leads or up to 10% via the trim function. However, the total output voltage trim-up should not exceed 10% of  $V_{OUT(NOM)}$ .

<sup>2</sup> Operating ambient temperature range of  $-40\text{ }^\circ\text{C}$  to  $85\text{ }^\circ\text{C}$  for converter.

## Operations

### Input and Output Impedance

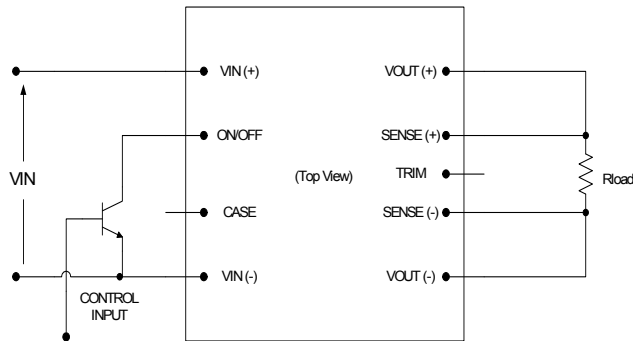
These power converters have been designed to be stable with no external capacitors when used in low inductance input and output circuits.

In many applications, the inductance associated with the distribution from the power source to the input of the converter can affect the stability of the converter. The addition of a 100  $\mu\text{F}$  electrolytic capacitor with an ESR  $< 1 \Omega$  across the input helps to ensure stability of the converter. In many applications, the user has to use decoupling capacitance at the load. The power converter will exhibit stable operation with external load capacitance up to 15,000  $\mu\text{F}$  on the output.

Additionally, see the EMC section of this data sheet for discussion of other external components which may be required for control of conducted emissions.

### ON/OFF (Pin 2)

The ON/OFF pin is used to turn the power converter on or off remotely via a system signal. There are two remote control options available, positive and negative logic, with both referenced to  $V_{in(-)}$ . A typical connection is shown in Fig. A.



**Fig. A: Circuit configuration for ON/OFF function.**

The positive logic version turns on when the ON/OFF pin is at a logic high and turns off when at a logic low. The converter is on when the ON/OFF pin is left open. See the Electrical Specifications for logic high/low definitions.

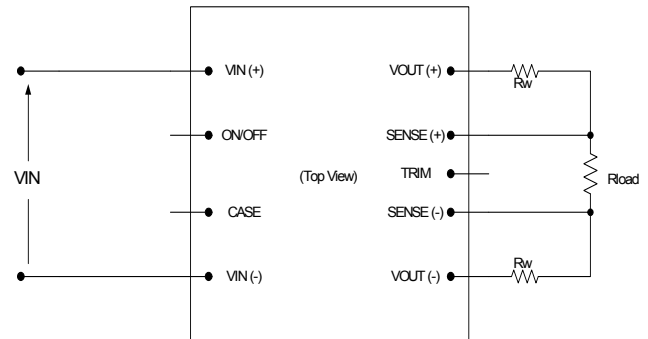
The negative logic version turns on when the pin is at a logic low and turns off when the pin is at a logic high. The ON/OFF pin can be hardwired directly to  $V_{in(-)}$  to enable automatic power up of the converter without the need of an external control signal.

The ON/OFF pin is internally pulled up to 5 VDC through a resistor. A properly de-bounced mechanical switch, open-collector transistor, or FET can be used to drive the input of the ON/OFF pin.

The device must be capable of sinking up to 0.2 mA at a low level voltage of  $\leq 0.8 \text{ V}$ . An external voltage source ( $\pm 20 \text{ V}$  maximum) may be connected directly to the ON/OFF input, in which case it must be capable of sourcing or sinking up to 1 mA depending on the signal polarity. See the Startup Information section for system timing waveforms associated with use of the ON/OFF pin.

### Remote Sense (Pins 6 and 8)

The remote sense feature of the converter compensates for voltage drops occurring between the output pins of the converter and the load. The SENSE(-) (Pin 6) and SENSE(+) (Pin 8) pins should be connected at the load or at the point where regulation is required (see Fig. B).



**Fig. B: Remote sense circuit configuration.**

### CAUTION

If remote sensing is not utilized, the SENSE(-) pin must be connected to the  $V_{out(-)}$  pin (Pin 5), and the SENSE(+) pin must be connected to the  $V_{out(+)}$  pin (Pin 9) to ensure the converter will regulate at the specified output voltage. If these connections are not made, the converter will deliver an output voltage that is slightly higher than the specified data sheet value.

Because the sense leads carry minimal current, large traces on the end-user board are not required. However, sense traces should be run side by side and located close to a ground plane to minimize system noise and ensure optimum performance.

The converter's output overvoltage protection (OVP) circuitry senses the voltage across  $V_{out(+)}$  and  $V_{out(-)}$ , and not across the +/- sense lines, so the resistance (and resulting voltage drop) between the output pins of the converter and the load should be minimized to prevent unwanted triggering of the OVP.

When utilizing the remote sense feature, care must be taken not to exceed the maximum allowable output power capability of the converter, which is equal to the product of the nominal output voltage and the allowable output current for the given conditions.

When using remote sense, the output voltage at the converter can be increased by as much as 10% above the nominal rating in order to maintain the required voltage across the load. Therefore, the designer must, if necessary, decrease the maximum current (originally obtained from the derating curves) by the same percentage to ensure the converter's actual output power remains at or below the maximum allowable output power.

### Output Voltage Adjust /TRIM (Pin 7)

The output voltage can be adjusted up 10% or down 20% relative to the rated output voltage by the addition of an externally connected resistor. (Trim up to 10% at full load is guaranteed at  $V_{in} \geq 40V$ .)

The TRIM pin should be left open if trimming is not being used. To minimize noise pickup, a 0.1  $\mu F$  capacitor is connected internally between the TRIM and SENSE(-) pin.

To increase the output voltage, refer to Fig. C. A trim resistor,  $R_{T-INCR}$ , should be connected between the TRIM (Pin 7) and SENSE(+) (Pin 8), with a value of:

$$R_{T-INCR} = \frac{V_{O-NOM}(100 + \Delta)}{1.225\Delta} - \frac{(100 + 2\Delta)}{\Delta} \quad [k\Omega]$$

where,

$R_{T-INCR}$  = Required value of trim-up resistor [k $\Omega$ ]

$V_{O-NOM}$  = Nominal value of output voltage [V]

$$\Delta = \left| \frac{(V_{O-REQ} - V_{O-NOM})}{V_{O-NOM}} \right| \times 100 \quad [\%]$$

$V_{O-REQ}$  = Desired (trimmed) output voltage [V].

When trimming up, care must be taken not to exceed the converter's maximum allowable output power. See the previous section for a complete discussion of this requirement.

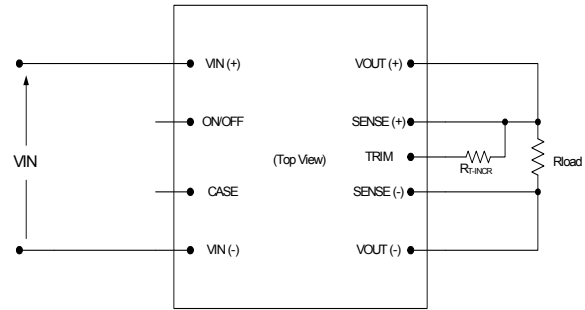


Fig. C: Configuration for increasing output voltage.

To decrease the output voltage (Fig. D), a trim resistor,  $R_{T-DECR}$ , should be connected between the TRIM (Pin 7) and SENSE(-) (Pin 6), with a value of:

$$R_{T-DECR} = \frac{100}{|\Delta|} - 2 \quad [k\Omega]$$

where,

$R_{T-DECR}$  = Required value of trim-down resistor [k $\Omega$ ]  
and  $\Delta$  is defined above.

### Note:

The above equations for calculation of trim resistor values match those typically used in conventional industry-standard half-bricks.

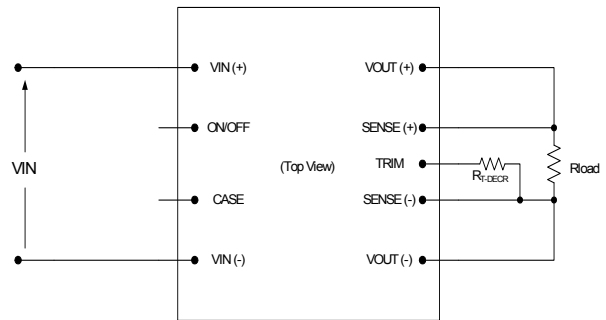


Fig. D: Configuration for decreasing output voltage.

Trimming/sensing beyond 110% of the rated output voltage is not an acceptable design practice, as this condition could cause unwanted triggering of the output overvoltage protection (OVP) circuit. The designer should ensure that the difference between the voltages across the converter's output pins and its sense pins does not exceed 110% of  $V_{OUT(NOM)}$ , or:

$$|V_{OUT(+)} - V_{OUT(-)}| - |V_{SENSE(+)} - V_{SENSE(-)}| \leq V_{O-NOM} \times 10\% \quad [V]$$

This equation is applicable for any condition of output sensing and/or output trim.

## Protection Features

### Input Undervoltage Lockout (UVLO)

Input undervoltage lockout is standard with this converter. The converter will shut down when the input voltage drops below a pre-determined voltage.

The input voltage must be typically 34 V for the converter to turn on. Once the converter has been turned on, it will shut off when the input voltage drops typically below 32 V. This feature is beneficial in preventing deep discharging of batteries used in telecom applications.

### Output Overcurrent Protection (OCP)

The converter is protected against overcurrent or short circuit conditions. Upon sensing an overcurrent condition, the converter will switch to constant current operation and thereby begin to reduce output voltage. When the output voltage drops below 60% of the nominal value of output voltage, the converter will shut down.

Once the converter has shut down, it will attempt to restart nominally every 200 ms with a typical 3-5% duty cycle. The attempted restart will continue indefinitely until the overload or short circuit conditions are removed or the output voltage rises above 60% of its nominal value.

Once the output current is brought back into its specified range, the converter automatically exits the hiccup mode and continues normal operation.

### Output Overvoltage Protection (OVP)

The converter will shut down if the output voltage across Vout(+) (Pin 9) and Vout(-) (Pin 5) exceeds the threshold of the OVP circuitry. The OVP circuitry contains its own reference voltage, independent of the output voltage regulation loop. Once the converter has shut down, it will latch off. The latch can be reset by toggling the enable pin OFF then ON or by recycling the input voltage.

### Overtemperature Protection (OTP)

The converter will shut down under an overtemperature condition to protect itself from overheating caused by operation outside the thermal derating curves, or operation in abnormal conditions such as system fan failure. After the converter has cooled to a safe operating temperature, it will automatically restart.

### Safety Requirements

The converters meet North American and International safety regulatory requirements per UL60950-1 and EN60950-1. Basic Insulation is provided between input and output.

To comply with safety agencies' requirements, an input line fuse must be used external to the converter. A 15 Amp fuse is recommended for use with this product.

The HBC48T25120 converter is UL approved for a maximum fuse rating of 15 Amps. To protect a group of converters with a single fuse, the rating can be increased from the recommended value above.



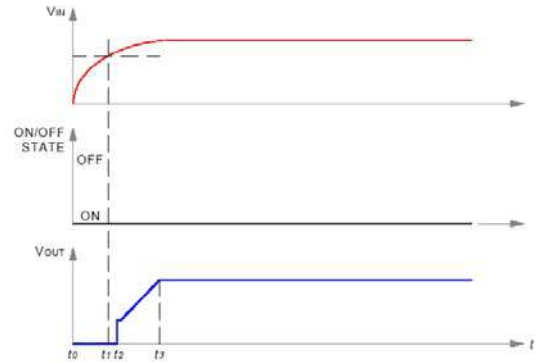
**Startup Information (using negative ON/OFF)**

**Scenario #1: Initial Startup From Bulk Supply**

ON/OFF function enabled, converter started via application of  $V_{IN}$ . See Figure E.

Time	Comments
$t_0$	ON/OFF pin is ON; system front end power is toggled on, $V_{IN}$ to converter begins to rise.
$t_1$	$V_{IN}$ crosses undervoltage Lockout protection circuit threshold; converter enabled.
$t_2$	Converter begins to respond to turn-on command (after <b>50ms</b> turn-on delay).
$t_3$	Converter $V_{OUT}$ reaches 100% of nominal value.

For this example, the total converter startup time ( $t_3 - t_1$ ) is typically **54 ms**.



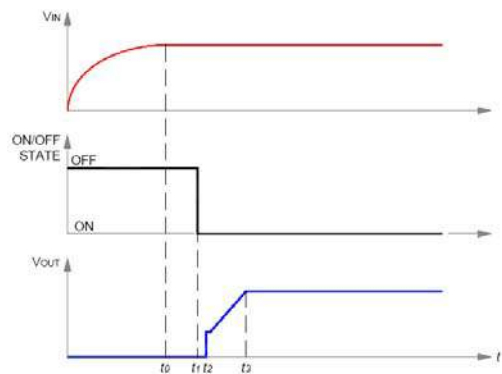
**Fig. E: Startup scenario #1.**

**Scenario #2: Initial Startup Using ON/OFF Pin**

With  $V_{IN}$  previously powered, converter started via ON/OFF pin. See Figure F.

Time	Comments
$t_0$	$V_{INPUT}$ at nominal value.
$t_1$	Arbitrary time when ON/OFF pin is enabled (converter enabled).
$t_2$	End of converter turn-on delay.
$t_3$	Converter $V_{OUT}$ reaches 100% of nominal value.

For this example, the total converter startup time ( $t_3 - t_1$ ) is typically **4 ms**.



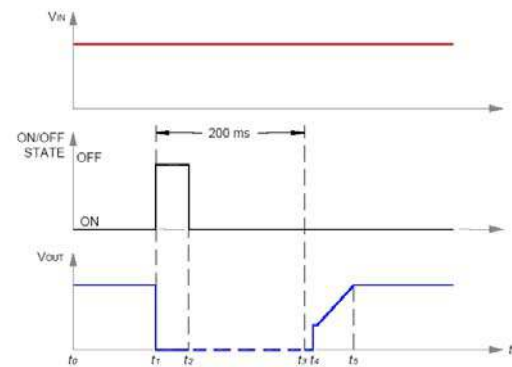
**Fig. F: Startup scenario #2.**

**Scenario #3: Turn-off and Restart Using ON/OFF Pin**

With  $V_{IN}$  previously powered, converter is disabled and then enabled via ON/OFF pin. See Figure G.

Time	Comments
$t_0$	$V_{IN}$ and $V_{OUT}$ are at nominal values; ON/OFF pin ON.
$t_1$	ON/OFF pin arbitrarily disabled; converter output falls to zero; turn-on inhibit delay period (200 ms typical) is initiated, and ON/OFF pin action is internally inhibited.
$t_2$	ON/OFF pin is externally re-enabled. If $(t_2 - t_1) \leq 200$ ms, external action of ON/OFF pin is locked out by startup inhibit timer. If $(t_2 - t_1) > 200$ ms, ON/OFF pin action is internally enabled.
$t_3$	Turn-on inhibit delay period ends. If ON/OFF pin is ON, converter begins turn-on; if off, converter awaits ON/OFF pin ON signal; see Figure F.
$t_4$	End of converter turn-on delay.
$t_5$	Converter $V_{OUT}$ reaches 100% of nominal value.

For the condition,  $(t_2 - t_1) \leq 200$  ms, the total converter startup time ( $t_5 - t_2$ ) is typically **204 ms**. For  $(t_2 - t_1) > 200$  ms, startup will be typically **4 ms** after release of ON/OFF pin.



**Fig. G: Startup scenario #3.**

## Characterization

### General Information

The converter has been characterized for many operational aspects, to include thermal derating (maximum load current as a function of ambient temperature and airflow) for horizontal mountings, efficiency, startup and shutdown parameters, output ripple and noise, transient response to load step-change, overload, and short circuit.

The following pages contain specific plots or waveforms associated with the converter. Additional comments for specific data are provided below.

### Test Conditions

All data presented were taken with the converter soldered to a test board, specifically a 0.060" thick printed wiring board (PWB) with four layers. The top and bottom layers were not metalized. The two inner layers, comprised of two-ounce copper, were used to provide traces for connectivity to the converter.

The lack of metallization on the outer layers as well as the limited thermal connection ensured that heat transfer from the converter to the PWB was minimized. This provides a worst-case but consistent scenario for thermal derating purposes.

All measurements requiring airflow were made in the vertical and horizontal wind tunnel using Infrared (IR) thermography and thermocouples for thermometry.

Ensuring components on the converter do not exceed their ratings is important to maintaining high reliability. If one anticipates operating the converter at or close to the maximum loads specified in the derating curves, it is prudent to check actual derating temperatures in the application. Thermographic imaging is preferable; if this capability is not available, then thermocouples may be used. The use of AWG #40 thermocouples is recommended to ensure measurement accuracy. Careful routing of the thermocouple leads will further minimize measurement error. Refer to Fig. H and Fig. I for the optimum thermocouple locations.

### Thermal Derating

Load current vs. ambient temperature and airflow rates are given in Fig. 1 and Fig. 2 for horizontal converter mountings, with and without baseplate option. Ambient temperature was varied between 25 °C and 85 °C, with airflow rates from 30 to 400 LFM (0.15 to 2.0 m/s). For each set of conditions, the maximum load current was defined as the lowest of:

- (i) The output current at which any FET junction temperature does not exceed a maximum specified temperature of 125 °C as indicated by a thermocouple measurement, or
- (ii) The output current at which the base plate temperature does not exceed a maximum specified temperature of 110 °C as indicated by thermocouple measure, or
- (iii) The nominal rating of the converter (25 A).

During normal operation, derating curves with maximum FET temperature less or equal to 125 °C should not be exceeded. Temperature at the thermocouple location shown in Fig. H and I should not exceed 125 °C and 110°C respectively in order to operate inside the derating curves.

### Efficiency

Fig. 3 shows the efficiency vs. load current plot for an ambient temperature of 25 °C, airflow rate of 300 LFM (1.5 m/s) with horizontal mounting and input voltages of 36 V, 48 V and 72 V. Also, a plot of efficiency vs. load current, as a function of ambient temperature with  $V_{in} = 48$  V, airflow rate of 200 LFM (1 m/s) with vertical mounting is shown in Fig. 4.

### Power Dissipation

Fig. 5 shows the power dissipation vs. load current plot for  $T_a = 25$  °C, airflow rate of 300 LFM (1.5 m/s) with vertical mounting and input voltages of 36 V, 48 V and 75 V. Also, a plot of power dissipation vs. load current, as a function of ambient temperature with  $V_{in} = 48$  V, airflow rate of 200 LFM (1 m/s) with vertical mounting is shown in Fig. 6.

### Startup

Output voltage waveforms, during the turn-on transient using the ON/OFF pin for full rated load currents (resistive load) are shown without and with external load capacitance in Figs. 7-8, respectively.



### Dynamic Load Response

Figs. 9-10 capture the converter's loop response when subjected to a step load change of 50% load to 75% load to 50% load. Two load slew rates are shown with minimal and maximum external capacitive loading conditions.

### Ripple and Noise

Fig. 11 shows the output voltage ripple waveform, measured at full rated load current with a 10  $\mu$ F tantalum and 1  $\mu$ F ceramic capacitor across the output. Note that all output voltage waveforms are measured across a 1  $\mu$ F ceramic capacitor. The input reflected ripple current waveforms are obtained using the test setup shown in Fig 12. The corresponding waveforms are shown in Figs. 13-14.

### Output Current Limiting

Fig. 15 shows the output load current behavior. Fig. 16 illustrates the converter's response to a shorted output condition.

### Electromagnetic Compatibility (EMC)

EMC requirements must be met at the end-product system level, as no specific standards dedicated to EMC characteristics of board mounted component dc-dc converters exist. However, Power-One tests its converters to several system level standards, primary of which is the more stringent EN55022, *Information technology equipment - Radio disturbance characteristics-Limits and methods of measurement*.

An effective internal LC differential filter significantly reduces input reflected ripple current, and improves EMC.

With the addition of a simple external filter, the HBC48T25120 converter will pass the requirements of Class B conducted emissions per EN55022 and FCC requirements. Please contact Power-One Applications Engineering for details of this testing.

### Temperature Reference Information

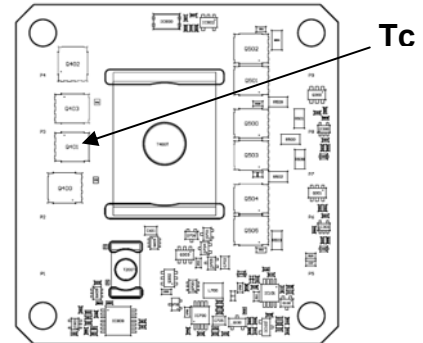


Fig. H: Tc Reference Point Location (w/o Baseplate)

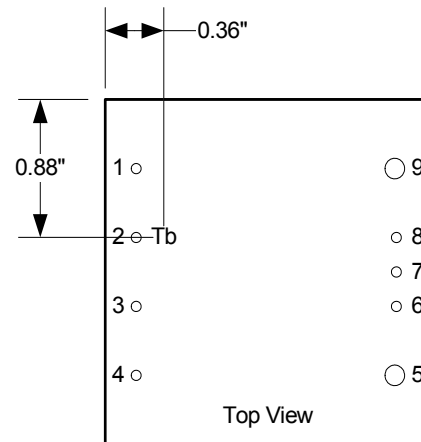
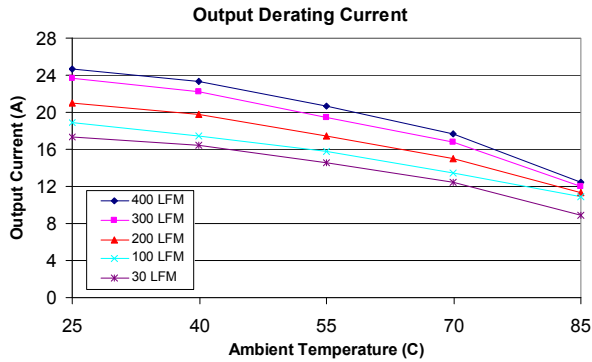


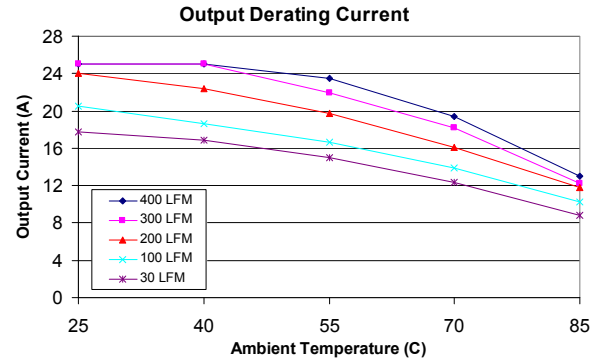
Fig. I: Tb Reference Point Location (w/ Baseplate)

**Characterization (con't)**

**Output Current Derating,  $f$  (  $T_A$  & Airflow )**

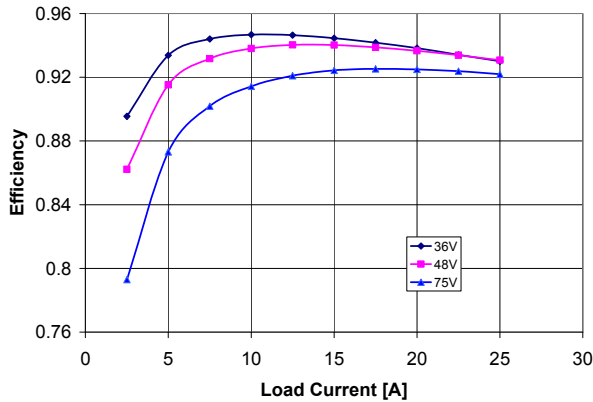


**Fig. 1 :** Available load current vs. ambient air temperature and airflow rates for single board converter mounted horizontally with air flowing from pin 4 to pin 1, MOSFET junction temperature  $\leq 125$  °C,  $V_{in} = 48$  V.

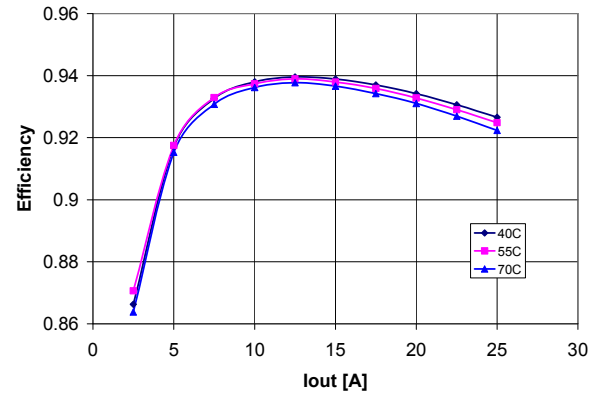


**Fig. 2:** Available load current vs. ambient air temperature and airflow rates for converter with baseplate mounted horizontally with air flowing from pin 4 to pin 1, baseplate temperature  $\leq 110$  °C,  $V_{in} = 48$  V.

**Efficiency,  $f$  ( Load Current &  $V_{in}$  )**

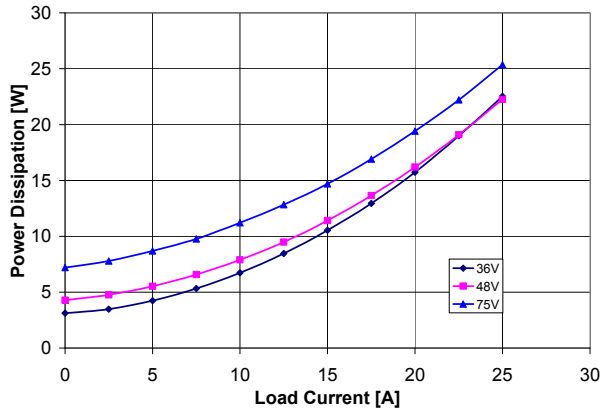


**Fig. 3:** Efficiency vs. load current and input voltage for converter mounted vertically with air flowing from pin 4 to pin 1 at a rate of 300 LFM (1.5 m/s) and  $T_a = 25$  °C.

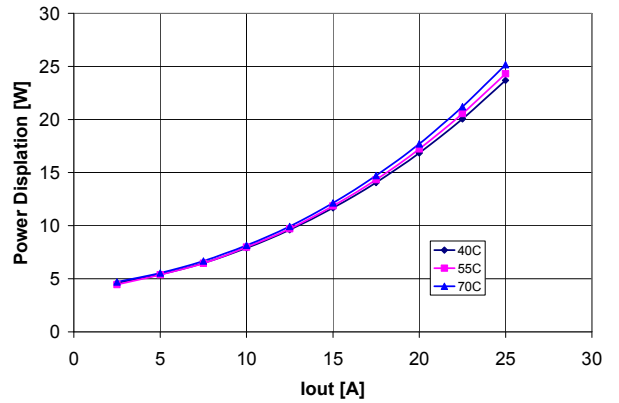


**Fig. 4:** Efficiency vs. load current and ambient temperature for converter mounted vertically with  $V_{in} = 48$  V and air flowing from pin 4 to pin 1 at a rate of 200 LFM (1.0 m/s).

**Power Dissipation,  $f$  (Load Current & Vin)**

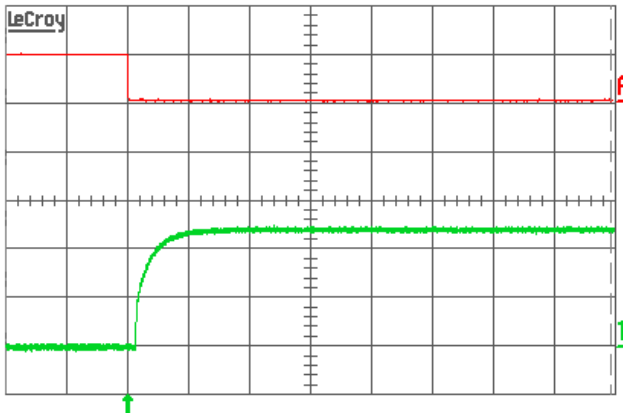


**Fig. 5:** Power dissipation vs. load current and input voltage for converter mounted vertically with air flowing from pin 4 to pin 1 at a rate of 300 LFM (1.5 m/s) and  $T_a = 25^\circ\text{C}$ .

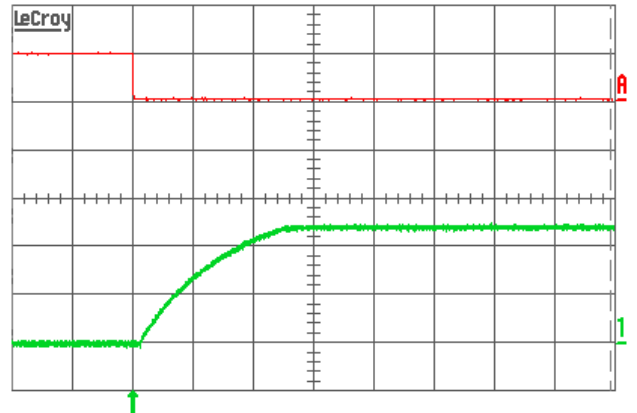


**Fig. 6:** Power dissipation vs. load current and ambient temperature for converter mounted vertically with  $V_{in} = 48\text{V}$  and air flowing from pin 4 to pin 1 at a rate of 200 LFM (1.0 m/s).

**Vo Startup**

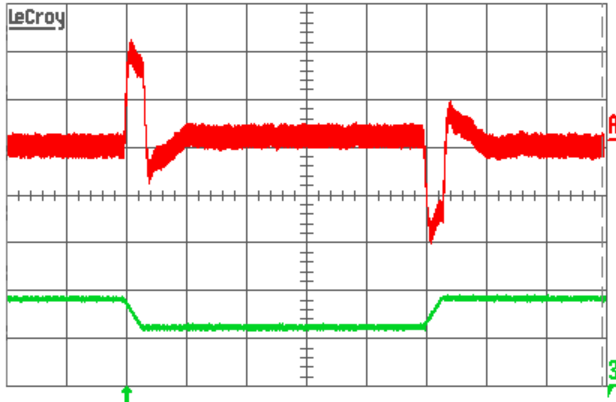


**Fig. 7:** Turn-on transient at full rated load current (resistive) with no output capacitor at  $V_{in} = 48\text{V}$ , triggered via ON/OFF pin. Top trace: ON/OFF signal (5 V/div.). Bottom trace: output voltage (5 V/div.). Time scale: 5 ms/div.

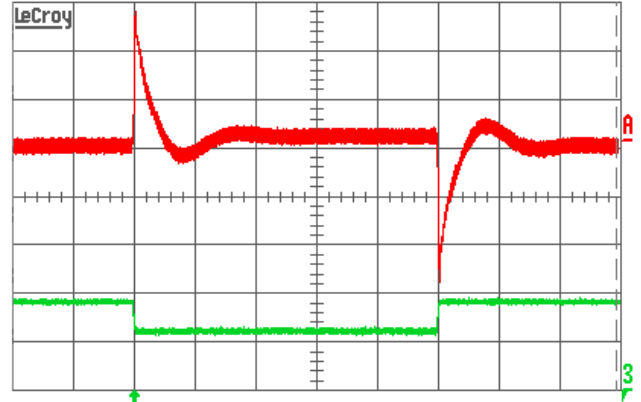


**Fig. 8:** Turn-on transient at full rated load current (resistive) plus 15,000  $\mu\text{F}$  at  $V_{in} = 48\text{V}$ , triggered via ON/OFF pin. Top trace: ON/OFF signal (5 V/div.). Bottom trace: output voltage (5 V/div.). Time scale: 5 ms/div.

**Dynamic Load Response**

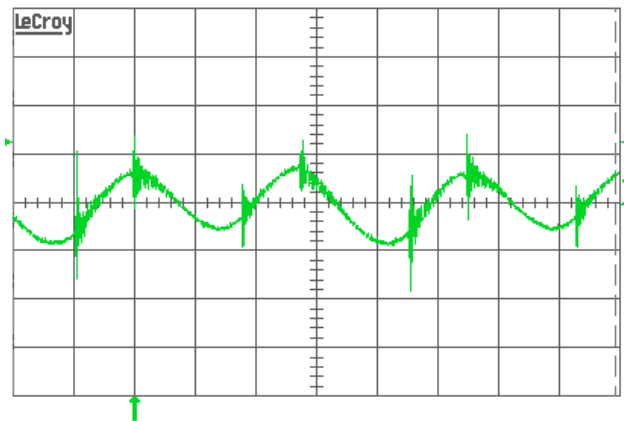


**Fig. 9:** Output voltage response to load current stepchange (12.5 A – 18.75 A – 12.5 A) at  $V_{in} = 48$  V. Top trace: output voltage (20 mV/div.). Bottom trace: load current (10 A/div.). Current slew rate: 0.1 A/ $\mu$ s.  $C_o = 10\mu$ F Tantalum + 1  $\mu$ F ceramic. Time scale: 0.2 ms/div.

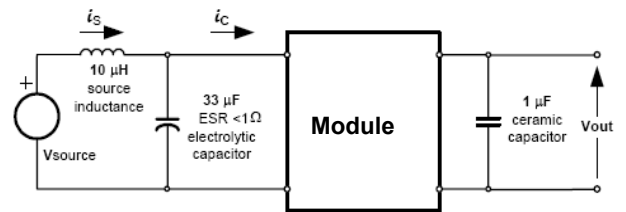


**Fig. 10:** Output voltage response to load current stepchange (12.5 A – 18.75 A – 12.5 A) at  $V_{in} = 48$  V. Top trace: output voltage (20 mV/div.). Bottom trace: load current (10 A/div.). Current slew rate: 1 A/ $\mu$ s.  $C_o = 15,000$   $\mu$ F OSCON + 1  $\mu$ F ceramic. Time scale: 0.2 ms/div.

**Output Ripple**

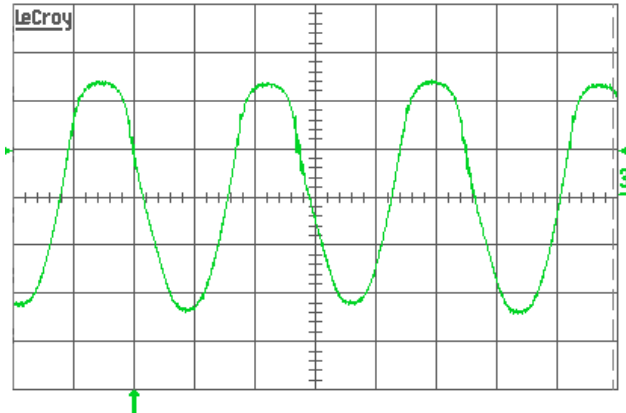


**Fig. 11:** Output voltage ripple (20 mV/div.) at full rated load current into a resistive load with  $C_o = 10$   $\mu$ F tantalum + 1  $\mu$ F ceramic and  $V_{in} = 48$  V. Time scale: 1  $\mu$ s/div.

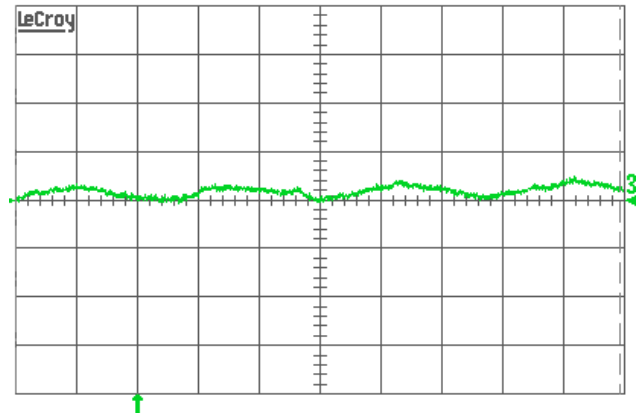


**Fig. 12:** Test setup for measuring input reflected ripple currents,  $i_c$  and  $i_s$ .

**Input Reflected Ripple Current**

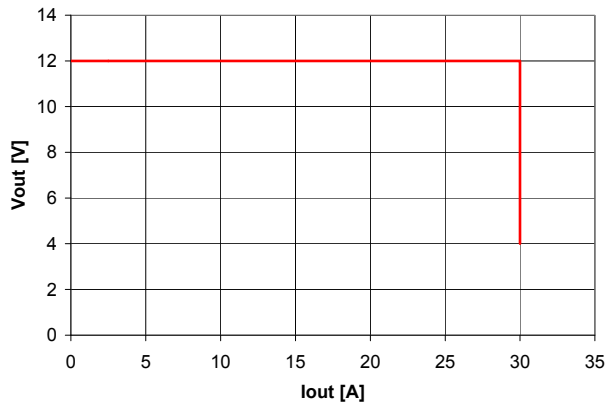


**Fig. 13:** Input reflected ripple current,  $i_c$  (200 mA/div.), measured at input terminals at full rated load current and  $V_{in} = 48$  V. Refer to Fig. 12 for test setup. Time scale: 1  $\mu$ s/div.

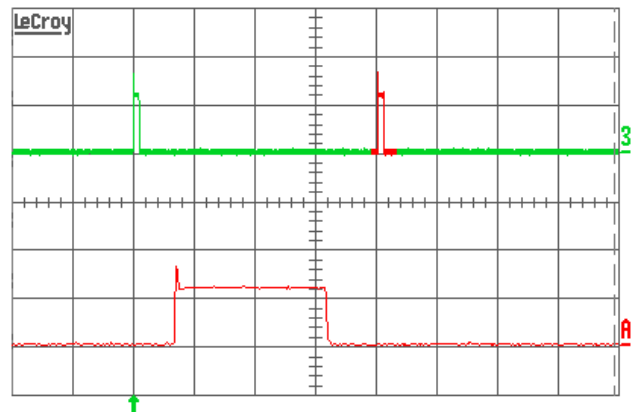


**Fig. 14:** Input reflected ripple current,  $i_s$  (10 mA/div.), measured through 10  $\mu$ H at the source at full rated load current and  $V_{in} = 48$  V. Refer to Fig. 12 for test setup. Time scale: 1  $\mu$ s/div.

**Output Current Limiting**



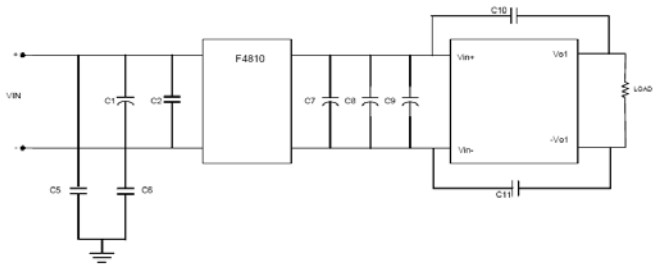
**Fig. 15:** Output voltage vs. load current showing current limit point and converter shutdown point. Input voltage has almost no effect on current limit characteristic.



**Fig. 16:** Load current (top trace, 20 A/div., 50 ms/div.) into a 10  $m\Omega$  short circuit during restart, at  $V_{in} = 48$  V. Bottom trace (20 A/div., 2 ms/div.) is an expansion of the on-time portion of the top trace.

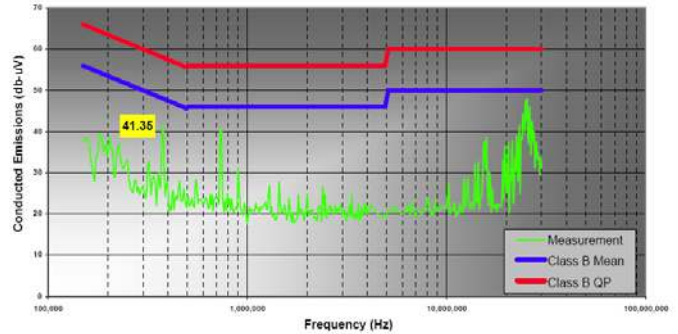
**Conducted EMI, Input Lines**

The following conducted EMI filter configuration and component values are offered as a guideline to assist in designing an effective filter solution in the customer's application. Many factors can affect overall EMI performance; such as layout, wire routing and load characteristics, among others. As a result, the final circuit configuration and component values may differ from that below.



Ref. Des	Description	Manufacturer
C2	3.3 $\mu$ F @100V MLC	AVX or Equivalent
C7, 8, 9	100 $\mu$ F @ 100V Alum. Electrolytic	Panasonic NGH Series or Equiv.
C5, 6, C10, 11	10,000 pF @ 1,000V MLC	AVX or Equivalent
F1	F4810 Input Filter Module	Power-One
C1	Not used	

**Fig. 18: EMI Filter Configuration & Component List**



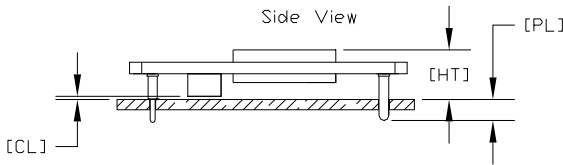
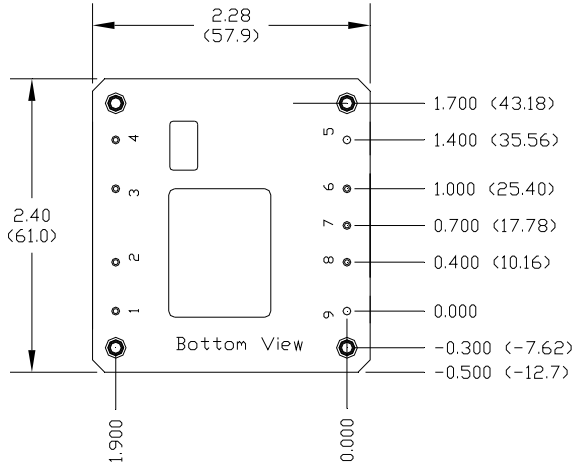
**Fig. 19: Conducted EMI Scan of the HBC48T25120 (w/ Input filter components per table above.)**

Test conditions:  $V_{in}$  = 48 Vdc,  $I_o$  = 80% rated (300 Watts)

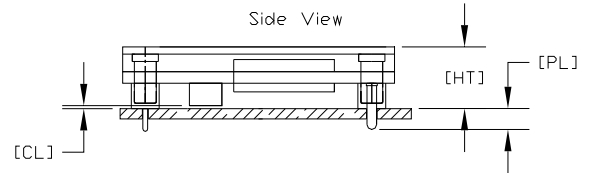
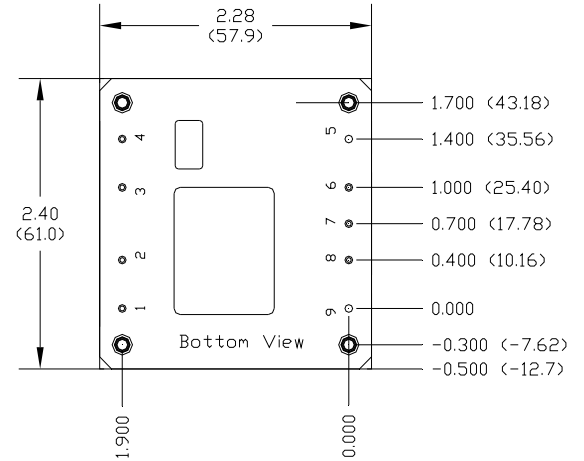
Test Specification: (CISPR-22) NE55022 Class B (Peak Detect)



**Physical Information**



**Figure J: HBC48T25120-xCx0  
(w/o Baseplate)**



**Figure K: HBC48T25120-xCxB  
(w/ Baseplate)**

Pad/Pin Connections	
Pad/Pin #	Function
1	Vin (+)
2	ON/OFF
3	Case (B Option)
4	Vin (-)
5	Vout (-)
6	SENSE(-)
7	TRIM
8	SENSE(+)
9	Vout (+)

**HBC48T25120 Platform Notes**

- All dimensions are in inches [mm]
- Pins 1-4 and 6-8 are  $\varnothing$  0.040" [1.02] with  $\varnothing$  0.078" [1.98] shoulder
- Pins 5 and 9 are  $\varnothing$  0.080" [2.03] without shoulder
- Pin Material & Finish: CDA 360 (brass) with 200-300 u" matte SN over 100-150 u" Ni
- Converter Weight: 2 oz [56.7 g] (stand alone)
- Converter Weight: 3 oz [85 g] (Heat sink mountable)

**Tolerances:** (Unless otherwise indicated)  
 x.xxx in. +/- .010 [x.xx mm +/- 0.25]  
 x.xx in. +/- .020 [x.x mm +/- 0.5]

### Converter Part Number Ordering Information

Height Option	HT (Max. Height)	CL (Min. Clearance)
	C ⇒ ±0.020 [+0.5]	+0.016 [+0.41] -0.000 [- 0.00]
C	0.50 [12.7]	0.035 [0.89]

Pin Option	PL Pin Length
	±0.005 [±0.13]
A	0.188 [4.78]
B	0.145 [3.68]

Product Series	Input Voltage	Mounting Scheme	Rated Load Current	Output Voltage		ON/OFF Logic	Maximum Height [HT]	Pin Length [PL]	Special Features	Environmental
HBC	48	T	25	120	-	N	C	A	0	
Half-Brick Format	36-75 V	T ⇒ Through-hole	25 A	120 ⇒ 12 V		N ⇒ Negative P ⇒ Positive	Through hole C ⇒ 0.50"	Through hole A ⇒ 0.188" B ⇒ 0.145"	0 ⇒ Std. B ⇒ Baseplate	No Suffix ⇒ RoHS lead-solder exemption compliant G ⇒ RoHS lead-free solder compliant

The example above describes P/N HBC48T25120-NCA0: 36-75 V input, through-hole mounting, 25 A @ 12 V output, negative ON/OFF logic, a maximum height of 0.50", a through the board pin length of 0.188", a single board (no baseplate), and Eutectic Tin/Lead solder<sup>1</sup>. Please consult factory for the complete list of available options.

<sup>1</sup> [suffix option -xxxx\_] The solder exemption is for customers choosing to elect the exemptions for lead in solders for servers, storage and storage array systems, and network infrastructure equipment for switching, signaling, transmission, and network management for telecommunications.

**NUCLEAR AND MEDICAL APPLICATIONS** - Power-One products are not designed, intended for use in, or authorized for use as critical components in life support systems, equipment used in hazardous environments, or nuclear control systems without the express written consent of the respective divisional president of Power-One, Inc.

**TECHNICAL REVISIONS** - The appearance of products, including safety agency certifications pictured on labels, may change depending on the date manufactured. Specifications are subject to change without notice.