



SPECIFICATIONS

Model	Stroke mm	Max Absorption Energy J(kgf·m)	Max Equivalent Mass kg(kgf)
FA-0805SB1-S	5	0.39(0.04)	3(3)

Max Drag N(kgf)	Absorption Energy per min. J/min(kgf·m/min)	Extension Force N(kgf)	Mass g
490 (50)	17.6(1.8)	4.9(0.5) or lower	8.6

■ The thread pitch P1.0 is supplied as well

COMMON SPECIFICATIONS

Range of Impact Rate	m/s	0.3~1
Maximum Cycle Rate	cycle/min	45
Operating Temperature	C°	-5~70

PRECAUTIONS FOR USE

- Do not use this product without carefully reading the attached owner's manual.
- Ensure that an external stopper (Stopper nut OP-020SB) is also used.
- Do not turn the oil inlet screw located at the bottom of the main unit.
- Ensure that sufficient mounting strength is secured for this product. (As a guideline, it should be 2 to 3 times the maximum drag listed in the catalogue.)
- Do not use this product in a vacuum or a location where it may come in contact with oil.
- Ensure that an eccentric load is not applied to the soft absorber. (Allowable eccentric angle: within $\pm 2.5^\circ$)

OPTIONAL PARTS

Eccentric angle adaptor OP-010MB

- Screw the eccentric angle adaptor into the main unit until the cap for the eccentric angle and the piston rod form a tight connection. While maintaining this position, fasten the main unit's nut until it is secured.
- Use the eccentric angle adaptor when the eccentric angle is 2.5° or larger.
- The main unit can also be used as a stopper.
- Use it with a capless soft absorber.
- The maximum operating eccentric angle with an eccentric angle adaptor is $\pm 10^\circ$.
- The caps and the guides for inclined use are not unbundled.

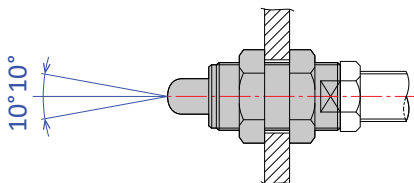
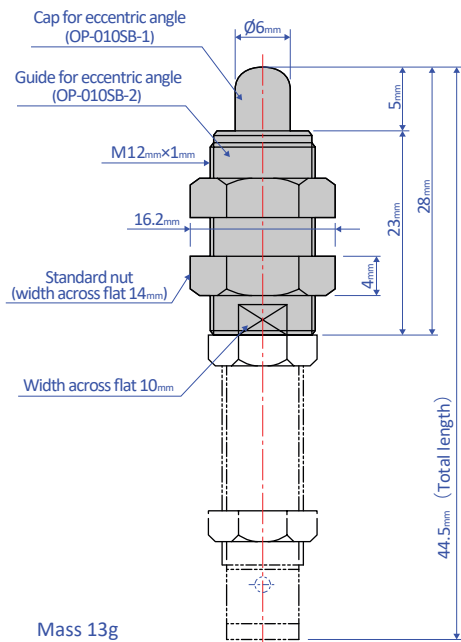

Note: Material of cap for eccentric angle: POM

Stopper nut OP-020SB

- Adjust so that it stops 1 mm before the stroke end, and fasten with the main unit's nut until secured.

OP-020SB-S (without cap)

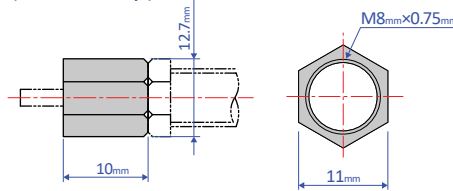

OP-020SB-C (with cap)

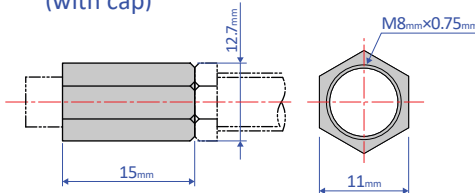

Mass 7g

Note: When attaching, make sure that the side without a bearing chamfer is the impact surface.

Standard nuts are sold separately as well - M08 Nut

Holder with a switch OP-030SB-2

- Although a holder with a switch can be ordered on its own, we strongly recommend ordering one with the main unit. Please include the main unit's model number when placing an order.

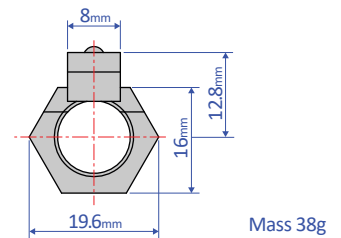
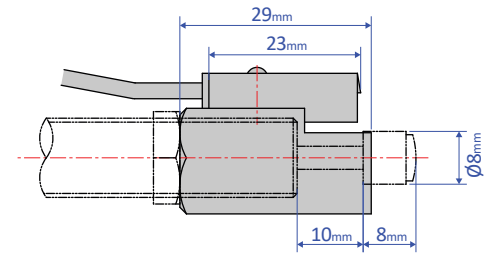

Mass 38g

Square flange OP-040SB

- Once the attachment site is determined, use the main unit's nut to securely fasten in place.

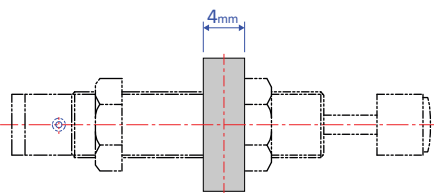
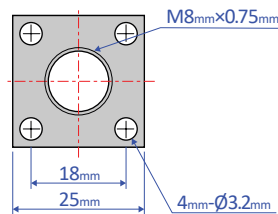

Mass 17g