

System Power Supply LSIs for use in automotive Electronics

Multifunction System Power Supply IC (with Watchdog Timer)

BD4911FM



●Description

The BD4911FM multiple-output system power supply features microcontroller output and is capable of operating at super-low dark current levels. With a built-in reset, with a microcontroller delay, BATTERY/ACCESSORY voltage detection, and mute function, WDT (Watch Dog Timer)function, the BD4911FM is ideal for car audio and satellite navigation systems.

●Features

- 1) Main regulator Vo1 can be switched between 5.0 V and 3.3 V output using the SEL input voltage, and can be used with an external boost transistor.
Sub-regulator Vo2 generates 3.3 V output.
Both regulators feature an output current of 150 mA.
- 2) Built-in WDT reset; monitor time can be set with the CTW capacitor.
WDT operation can be switched on and off using INH input.
- 3) Circuit current during standby operation (WDT off): 100 μ A (TYP)
- 4) Built-in reduced power detection circuits for Vo1 and Vo2 output
- 5) Built-in elevated output detection circuit for Vo1
- 6) The IC monitors the BuM voltage and outputs it to the BuDET1 and BuDET2 pins.
- 7) The IC monitors the ACCM voltage and outputs it to the ACCM pin when BuDET1 and BuDET2 are low.
- 8) Built-in mute circuit. Pulse width can be set with the CE capacitor.
- 9) Built-in power-on reset function for which RESET output can be set with the CTP capacitor.
- 10) Vo1 generates low-saturation voltage type PMOS output.
- 11) Built-in overcurrent protection circuit
- 12) Built-in overvoltage protection circuit
- 13) Built-in thermal shutdown circuit
- 14) The 28-pin HSOP-M28 package is ideal for space-saving designs.

●Applications

Car audio and satellite navigation systems

● **Absolute Maximum Ratings** (Ta = 25°C)

Parameter	Symbol	Limits	Unit
Supply Voltage 1	VIN1	-0.3 to 36	V
Supply Voltage 2	VIN2	-0.3 to 36	V
Power Dissipation	Pd	2200 (*1)	mW
Operating Temperature Range	Topr	-40 to +85	°C
Storage Temperature Range	Tstg	-55 to +150	°C
Peak Supply Voltage 1	VIN1 Peak	50 (*2)	V
Peak Supply Voltage 2	VIN2 Peak	50 (*2)	V
Surge Applied Current 1	IACC (S+)	+3 (*2)	mA
Surge Applied Current 2	IACC (S-)	-12 (*3)	mA
Maximum Junction Temperature	Tjmax	150	°C

*1: When mounted on a PCB (70 mm × 70 mm × 1.6 mm glass epoxy).

*2: tr ≥ 1 ms, Bias voltage/current is less than 200 ms or shorter

*3: tr ≥ 1 ms, Bias voltage/current 60 ms or shorter

● **Recommended operating ranges** (Ta = 25°C)

Parameter	Symbol	Limits			Unit	Comment
		Min.	Typ.	Max.		
Recommended Power Supply Voltage Range 1	VIN1	Vo1+1.2	13.2	16.0	V	When using built-in transistor.
	VIN1	Vo1 + 0.5 + external TrVBE	13.2	16.0	V	When using external boost transistor.
Recommended Power Supply Voltage Range 2	VIN2	4.5	13.2	16.0	V	
Recommended Power Supply Voltage Range 3	Vo1	1.2	—	5.2	V	RESET, DET1
Recommended Power Supply Voltage Range 4	Vo1	2.5	—	5.2	V	BuDET, ACCDET, MUTE, WDT
Recommended Power Supply Voltage Range 5	Vo2	1.2	—	3.4	V	DET2

*Electrical characteristics are not guaranteed (especially when operating on reduced voltage).

● **External element setting time** (Ta = 25°C)

Parameter	Symbol	Equation (TYP)	Unit	Recommendation	Unit	Condition
Runaway Operation Detection Time 1	TWD1	$700 \times CTW$ (μF)	mS	0.1 to 2.2	μF	SEL > 1.5 V
Runaway Operation Detection Time 2	TWD2	$462 \times CTW$ (μF)	mS	0.1 to 2.2	μF	SEL < 1.0 V
Runaway Operation Reset Time 1	TWR1	$340 \times CTW$ (μF)	mS	0.1 to 2.2	μF	SEL > 1.5 V
Runaway Operation Reset Time 2	TWR2	$260 \times CTW$ (μF)	mS	0.1 to 2.2	μF	SEL < 1.0 V
Power-on Reset Time	TPR	$1000 \times CTP$ (μF)	mS	0.047 to 0.22	μF	
CD Delay Time	Td	$100 \times CD$ (μF)	mS	0.047 to 0.22	μF	
MUTE Pulse Width	Tm	$1 \times CE$ (μF)	S	0.1 to 2.2	μF	
BuM Detection Voltage (rising)	VTHBu	$1.252 \times (R1+R2)/R2$	V	R1: 0.5 to 2	MΩ	
BuM Detection Voltage (falling)	VTLBu	$1.184 \times (R1+R2)/R2$	V	R2: 0.1 to 0.5		
ACCM Detection Voltage (rising)	VTHACC	$1.252 \times (R3 + R4)/R4$	V	R3: 50 to 200	kΩ	
ACCM Detection Voltage (falling)	ATLACC	$1.184 \times (R3+R4)/R4$	V	R4: 10 to 50		

● **Electrical characteristics** (Unless otherwise specified, Ta = 25°C, VIN1 = VIN2 = 13.2 V)

Parameter	Symbol	Limits			Unit	Condition
		Min.	Typ.	Max.		
[Overall]						
VIN1 Supply Current	IVIN1	65	95	125	μA	ACC = 0 V, WDINH = H
VIN2 Supply Current	IVIN2	5	10	20	μA	ACC = 0 V, WDINH = H
Total Supply Current	IVINA	65	100	135	μA	ACC = 0 V, WDINH = H
	IVINB	65	130	195	μA	ACC = 13.2 V
Overvoltage Detection Voltage	VOVP	28	31	34	V	All regulator output off
Overvoltage Detection Hysteresis Width	VOVPHY	0.5	1	1.5	V	All regulator output reset
[Main Regulator (REG1)]						
VO1 Output Voltage 1	VO1-1	4.8	5.0	5.2	V	VIN1 = 6.2 V to 16 V, Io1 = 0 mA to 150 mA, SEL > 1.5 V
VO1 Line Regulation 1	ΔVO1L-1	—	1	30	mV	VIN1 = 6.2 V to 16 V, SEL > 1.5 V
VO1 Load Regulation 1	ΔVO1L-1	—	7	50	mV	Io1 = 0 mA to 150 mA, SEL > 1.5 V
VO1 Output Voltage 2	VO1-2	3.168	3.3	3.432	V	VIN1 = 4.5 to 16 V, Io1 = 0 to 150 mA, SEL < 1.0 V
VO1 Line Regulation 2	ΔVO1L-2	—	1	30	mV	VIN1 = 4.5 V to 16 V, SEL < 1.0 V
VO1 Load Regulation 2	ΔVO1L-2	—	7	30	mV	Io1 = 0 mA to 150 mA, SEL < 1.0 V
Minimum VO1 Output	VO1-L	2.5	—	—	V	VIN1 = 3.0 V, Io1 = 0 mA
Short Protection Start Current	Io1max	150	400	600	mA	
Power Supply Ripple Rejection Ratio	RRVO1	45	55	—	dB	fin = 120 Hz, -10 dBV, Io1 = 150 mA
VO1 Sink Current	IVO1in	35	90	145	μA	Vo1 = 5 V, VIN1 = ACC = OPEN, WDINH = SEL = 5 V
[External Boost Transistor Current-limiting Circuit (OCP)]						
OCP Input Current	IOCP	0	0.1	1.0	μA	VOCP = VIN1 = 16 V
OCP Detection Voltage	VOCP1	360	400	440	mV	Voltage differential with VIN1
OCP Detection Voltage (During Output Ground Fault)	VOCP2	20	32	50	mV	Vo1 = 0 V, voltage differential with VIN1
[Elevated Output Detection Circuit (COMP)]						
Elevated Output Detection Voltage 1	VOVER1	5.30	5.49	5.68	V	SEL > 1.5 V
Elevated Output Detection Voltage 2	VOVER2	3.5	3.62	3.75	V	SEL < 1.0 V
Elevated Output Detection Output	VCOMP	—	0.1	0.4	V	VO1 > 5.68 V, Io = 100 μA
Output Off Delay Time	TmVoff	—	—	50	μS	Vo1: 3.1→4.8 V (tr = 0.01 V/μS) VIN1 = 4.8 V, Ro = 1 kΩ
[Sub-regulator (REG2)]						
VO2 Output Voltage	VO2	3.168	3.3	3.432	V	VIN1 = VIN2 = 4.5 V to 16V, Io2 = 0 mA to 150 mA,
VO2 Line Regulation	ΔVO2L	—	1	30	mV	VIN1 = VIN2 = 4.5 V to 16V
VO2 Load Regulation	ΔVO2L	—	7	30	mV	Io2 = 0 mA to 150 mA
Minimum VO2 Output	VO2-L	2.5	—	—	—	VIN1 = VIN2 = 3.0 V, Io2 = 0 mA
Short Protection Start Current	Io2max	150	400	600	mA	
Power Supply Ripple Rejection Ratio	RRVO2	45	55	—	dB	fin = 120 Hz, -10 dBV, Io2 = 150 mA
[Regulator Voltage Selection Circuit (SEL)]						
SEL Threshold	VTHSEL	1.20	1.25	1.30	V	
SEL Input Current	ISEL	1	2	4	μA	VSEL = 5 V
[VO1 Reduced-voltage Detection Circuit (DET1)]						
VO1 Detection Voltage 1	VTLP1-1	4.00	4.15	4.30	V	Vo1 falling, SEL > 1.5 V
Reset Voltage 1	VTHP1-1	4.10	4.35	4.60	V	Vo1 rising, SEL > 1.5 V
Hysteresis Width 1	VHSP1-1	0.1	0.2	0.3	V	SEL > 1.5 V
VO1 Detection Voltage 2	VTLP1-2	2.85	2.95	3.05	V	Vo1 falling, SEL < 1.0 V
Reset Voltage 2	VTHP1-2	2.92	3.09	3.26	V	Vo1 rising, SEL < 1.0 V
Hysteresis Width 2	VHSP1-2	0.07	0.14	0.21	V	SEL < 1.0 V
DET1 Output On Resistance	RDET1	—	270	600	Ω	IDET1 = 1 mA
DET1 Output Saturation Voltage	VDET1L	—	0.1	0.4	V	IDET1 = 2 μA, Vo1 = 1.2 V

© This IC is not designed to be radiation-resistant.

● **Electrical characteristics** (Unless otherwise specified, Ta = 25°C, VIN1 = VIN2 = 13.2 V)

Parameter	Symbol	Limits			Unit	Condition
		Min.	Typ.	Max.		
[VO2 Reduced-voltage Detection Circuit (DET2)]						
VO2 Detection Voltage	VTLP2	2.85	2.95	3.05	V	Vo2 falling
Reset Voltage	VTHP2	2.92	3.09	3.26	V	Vo2 rising
Hysteresis Width	VHSP2	0.07	0.14	0.21	V	
DET2 Output On Resistance	RDET2	—	270	600	Ω	IDET2 = 1 mA
DET2 Output Saturation Voltage	VDET2L	—	0.1	0.4	V	IDET2 = 2 μA, Vo1 = 1.2 V
[Power-on Reset Timer (CTP, RESET)]						
CTP Charge Resistance 1	RCTP1	0.6	0.9	1.2	MΩ	When RESET is low (while charging).
CTP Charge Resistance2	RCTP2	5.5	8.5	11.5	kΩ	When RESET is high (after charging is complete).
CTP Rising Threshold	VTHP1	3.00	3.33	3.66	V	SEL > 1.5 V
	VTHP2	1.98	2.2	2.42	V	SEL < 1.0 V
CTP Falling Threshold	VTLP1	1.50	1.67	1.83	V	SEL > 1.5 V
	VTLP2	0.9	1.0	1.1	V	SEL < 1.0 V
Power-on Reset Time	TPR	60	100	140	mS	CTP = 0.1 μF
Reset On Delay Time	TDR	10	50	100	μS	CTP = 0.1 μF
RESET Output On Resistance	RRST	—	—	100	Ω	IRST = 1 mA
RESET Low Output Voltage	VRSTL	—	—	0.4	V	IRST = 2 μA, Vo1 = 1.2 V
[Watchdog Timer (WDT, WDINH, CTW)]						
Runaway Operation Detection Time 1	TWD1	420	700	980	mS	Time from final WDT signal input to RESET inversion
Runaway Operation Detection Time 2	TWD2	277.2	462.0	646.8	mS	
Runaway Operation Reset Time 1	TWR1	204	340	476	mS	CT = 1 μF, VO1 = 5 V
Runaway Operation Reset Time 2	TWR2	156	260	364	mS	CT = 1 μF, VO1 = 3.3 V
CTW Charge Current (Source)	IHCTW	3.3	4.7	6.1	μA	
CTW Discharge Current (Sink)	ILCTW	3.4	4.8	6.2	μA	
CTW Rapid Discharge Resistance	RCTWon1	—	16	50	Ω	When WDT signal input is active.
	RCTWon2	—	0.5	2.5	kΩ	ACC: L, WDINH: H
CTW Rising Threshold	VTHW1	3.00	3.33	3.66	V	SEL > 1.5 V
	VTHW2	1.98	2.20	2.42	V	SEL < 1.0 V
CTW Falling Threshold	VTLW1	1.50	1.67	1.83	V	SEL > 1.5 V
	VTLW2	0.9	1.0	1.1	V	SE L ≤ 1.0 V
WDT Rrising Threshold	VTHWDT1	3.00	3.33	3.66	V	SEL > 1.5 V
	VTHWDT2	1.98	2.20	2.42	V	SEL < 1.0 V

© This IC is not designed to be radiation-resistant.

● **Electrical characteristics** (Unless otherwise specified, Ta = 25°C, VIN1 = VIN2 = 13.2 V)

Parameter	Symbol	Limits			Unit	Condition
		Min.	Typ.	Max.		
WDT Falling Threshold	VTLWDT1	1.50	1.67	1.83	V	SEL > 1.5 V
	VTLWDT2	0.9	1.0	1.1	V	SEL < 1.0 V
WDT Input Current	IWDT	0.5	1.0	2.0	μA	VWDT = 5 V, SEL > 1.5 V
WDT Ddge Pulse Width	TPULSE	100	190	300	μS	
WDINH Input Voltage At High Level	VIH	0.8X Vo1	—	—	V	
WDINH Input Voltage Low Level	VIL	—	—	0.3X Vo1	V	
WDT Input Current	IWDINH	1	2	4	μA	VWDINH = 5 V, SEL < 1.0 V
[Bu Voltage Detection Circuit (BuM, BuDET)]						
BuM Detection Voltage (Rising) BuDET: H→L, AccDET: H→L	VTHB	1.214	1.252	1.290	V	IC without heat sink
BuM Detection Voltage (Falling) BuDET: L→H, AccDET: L→H	VTLB	1.148	1.184	1.220	V	IC without heat sink
BuDET1 High Output Voltage	VBDTH1	Vo1 -0.4	Vo1 -0.2	—	V	Iout = -5 mA
BuDET1 Low Output Voltage	VBDTL1	—	0.15	0.40	V	Iout = 5 mA
BuDET2 High Output Voltage	VBDTH2	Vo2 -0.4	Vo2 -0.2	—	V	Iout = -5 mA
BuDET2 Low Output Voltage	VBDTL2	—	0.15	0.40	V	Iout = 5 mA
BuM Input Current	IBM1	0	4	110	nA	BuM = 1 V
	IBM2	0	20	110	nA	BuM = 2 V
[MUTE One-shot Pulse Generation Circuit (MUTE, CE)]						
MUTE Pulse Width	Tm1	0.6	1.0	1.4	S	CE = 1 μF, SEL > 1.5 V
	Tm2	0.6	1.0	1.4	S	CE = 1 μF, SEL < 1.0 V
MUTE Pulse On Delay Time	Td1	0	5	10	μS	CE = 1 μF, SEL > 1.5 V
	Td2	0	8	16	μS	CE = 1 μF, SEL < 1.0 V
CE Charge Resistance 1	RTM1	0.7	1.0	1.3	MΩ	When MUTE is on (resistance while charging).
CE Charge Resistance 2	RTM2	8.0	11.5	15.0	kΩ	When MUTE is off (resistance when stabilized after charging).
CE Rapid Discharge Resistance	RCEon	—	4	20	Ω	Must satisfy Td.
CE Output Saturation Voltage	VCEL	—	0.1	0.3	V	CE output on, ICE = 0 μA
CE-CMP Threshold (rising)	VTHCE1	3.00	3.33	3.66	V	SEL > 1.5 V
	VTHCE2	1.98	2.2	2.42	V	SEL < 1.0 V
CE-CMP Threshold (falling)	VTLCE1	1.50	1.67	1.83	V	SEL > 1.5 V
	VTLCE2	0.9	1.0	1.1	V	SEL < 1.0 V
MUTE Output Saturation Voltage	VMUTEL	—	0.2	0.4	V	IMUTE = 5 mA
[ACC Voltage Detection & Delay Circuit (ACCM, CD, ACCDET)]						
ACCM Detection Voltage (Rising)	VTHA	1.214	1.252	1.290	V	IC without heat sink, BuM = H
ACCM Detection Voltage (Falling)	VTLA	1.148	1.184	1.220	V	IC without heat sink, BuM = H
ACCM Positive Clamp Voltage	VHACC	8	11	14	V	IACCM = +5 mA
ACCM Negative Clamp Voltage	VLACC	-0.30	-0.15	0	V	IACCM = -12 mA
ACCM Input Current 1	IACC1	-5	-1	0	μA	ACCM = 0 V
ACCM Input Current 2	IACC2	0	10	110	nA	ACCM = 2 V
CD Delay Time	TdLH	6	10	14	mS	CD = 0.1 μF
	TdHL	6	10	14	mS	CD = 0.1 μF
CD Charge Resistance	ICDH	60	90	120	kΩ	
CD Discharge Resistance	ICDL	60	90	120	kΩ	
CD-CMP Threshold (Rising)	VTHCD1	3.00	3.33	3.66	V	SEL > 1.5 V
	VTHCD2	1.98	2.2	2.42	V	SEL < 1.0 V
CD-CMP Threshold (Falling)	VTLCD1	1.50	1.67	1.84	V	SEL > 1.5 V
	VTLCD2	0.9	1.0	1.1	V	SEL < 1.0 V
ACCDET Output Saturation Voltage	VADTL	—	0.2	0.4	V	IADT = 5 mA

© This IC is not designed to be radiation-resistant.

●Reference data (Unless otherwise specified, VIN1 = VIN2 = 13.2 V)

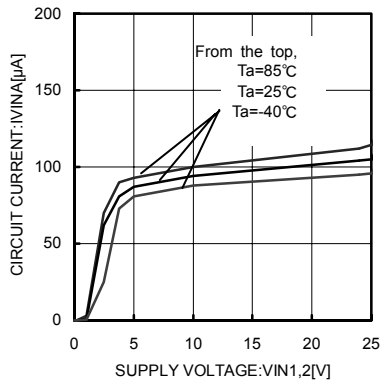

Fig.1 Total Circuit Current A

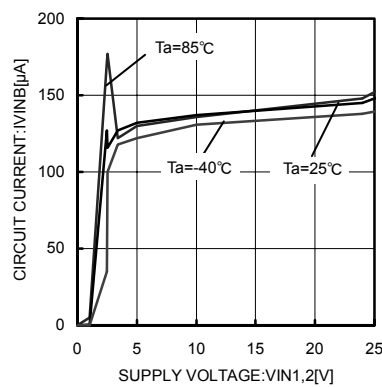

Fig.2 Total Circuit Current B

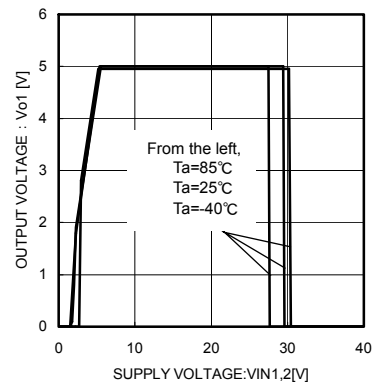

Fig.3 Vo1 Line Regulation

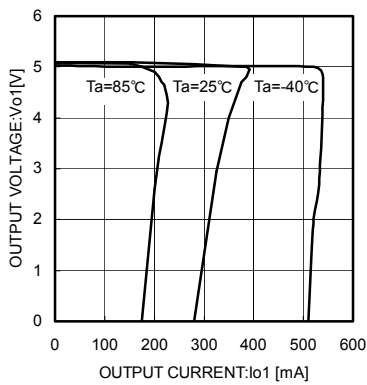

Fig.4 Vo1 Load Regulation

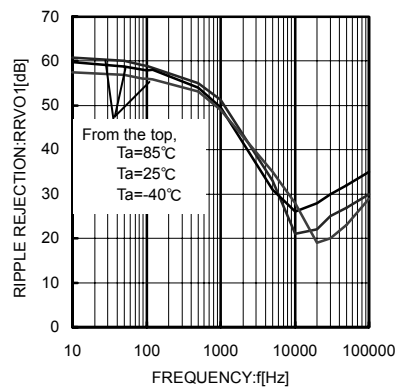

Fig.5 VO1 Ripple Rejection
VO1 = 5V

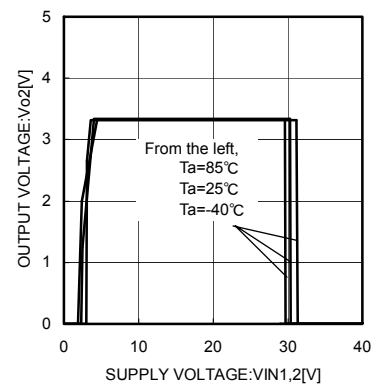

Fig.6 Vo2 Line Regulation

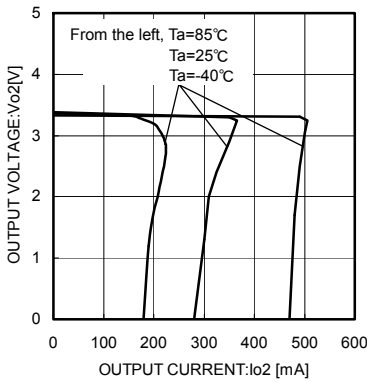

Fig.7 Vo2 Load Regulation

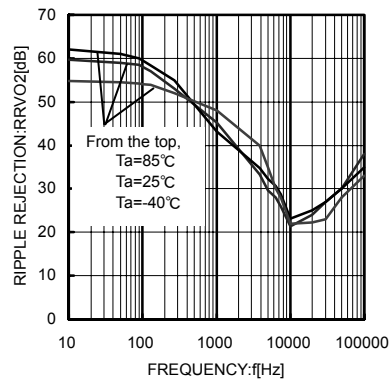

Fig.8 VO2 Ripple Rejection

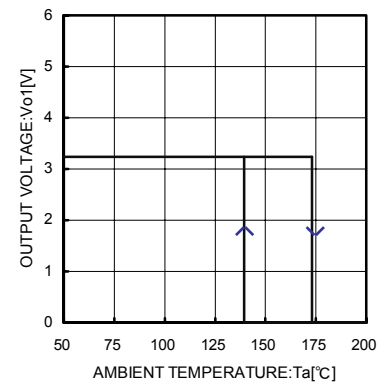

Fig.9 Thermal Shutdown Circuit

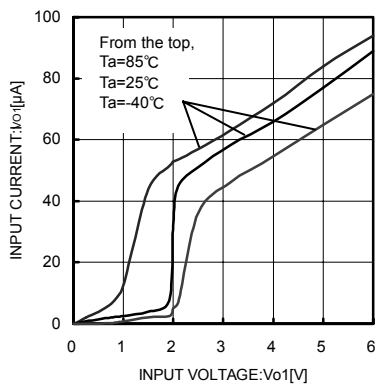

Fig.10 VO1 Sink Current

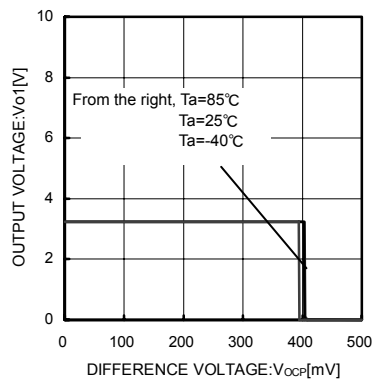

Fig.11 OCP Detection Voltage

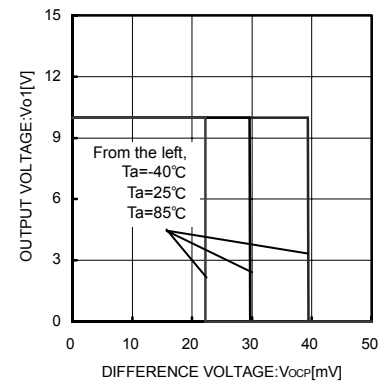

Fig.12 External OCP
Detection Voltage

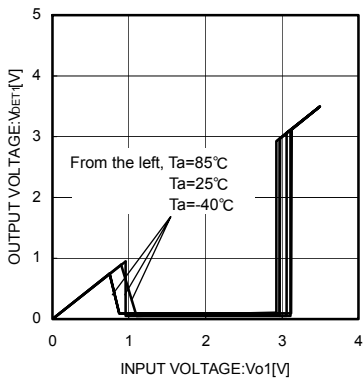

Fig.13 Vo1 Output Detection Voltage

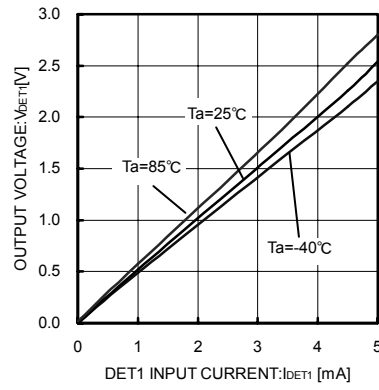

Fig.14 DET1 Output Voltage

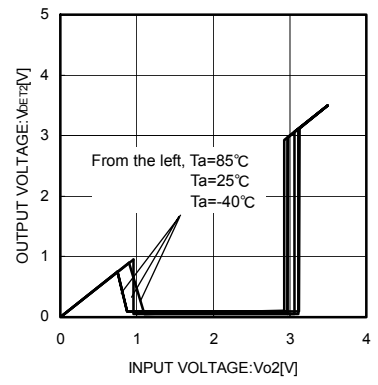

Fig.15 Vo2 Output Detection Voltage

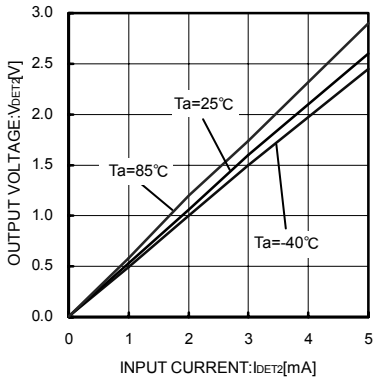

Fig.16 DET2 Output Voltage

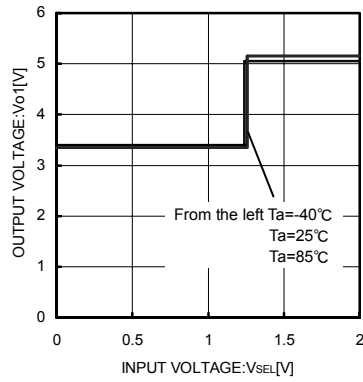

Fig.17 SEL Threshold Voltage

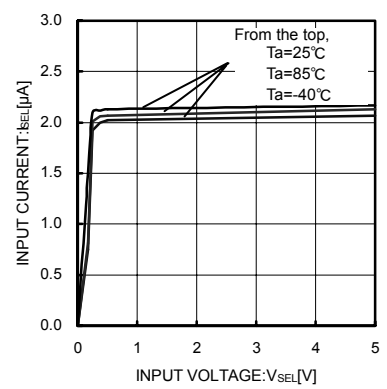

Fig.18 SEL Input Current

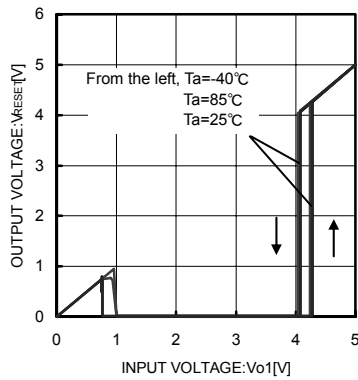

Fig.19 RESET Threshold Voltage

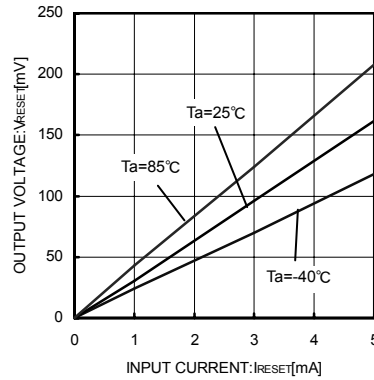

Fig.20 RESET Output Voltage

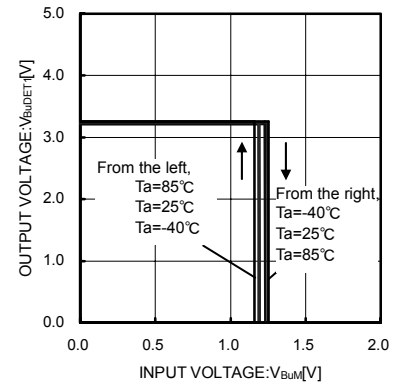

Fig.21 BuDET1 Detection Voltage

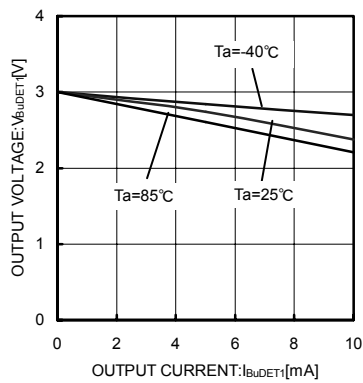

Fig.22 BuDET1 High Output Voltage

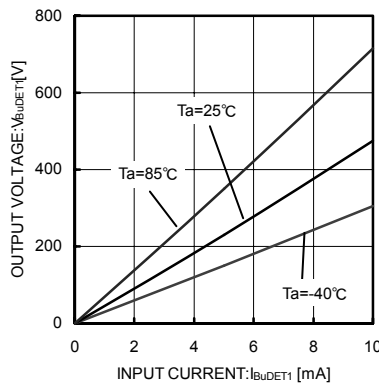

Fig.23 BuDET1 Low Output Voltage

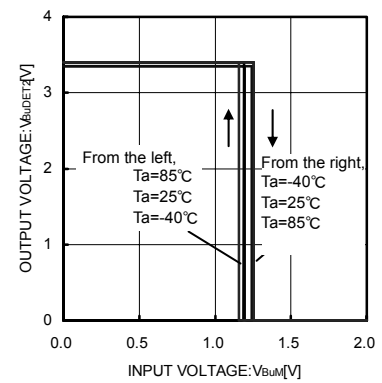

Fig.24 BuDET2 Detection Voltage

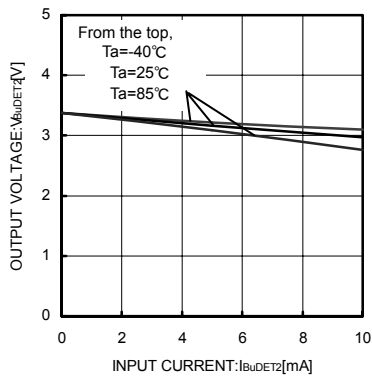

Fig.25 BuDET2 High Output Voltage

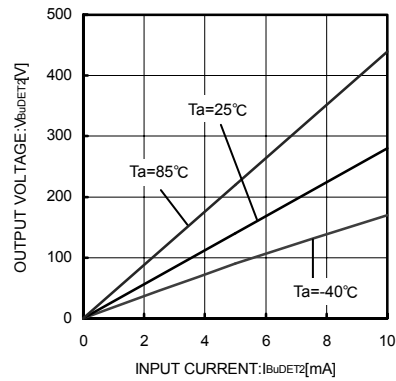

Fig.26 BuDET2 Low Output Voltage

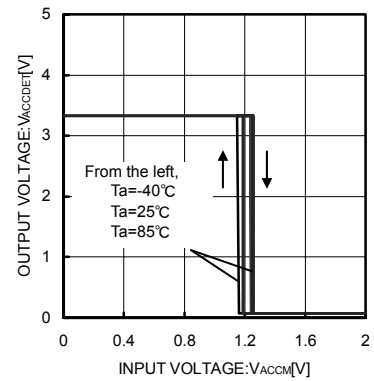

Fig.27 ACCDET Detection Voltage

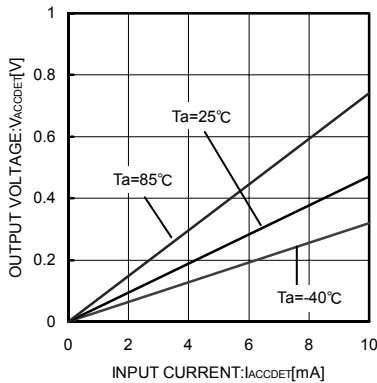

Fig.28 ACCDET Output Voltage

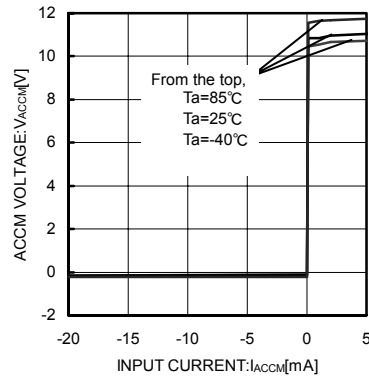

Fig. 29 ACCM Positive/Negative Clamp Voltage

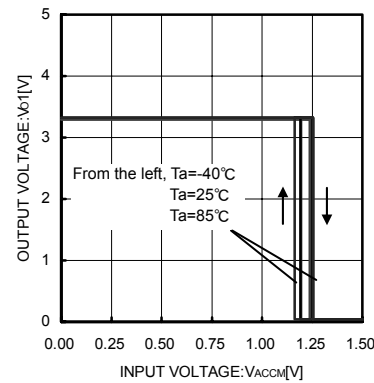

Fig.30 ACC Detection Voltage

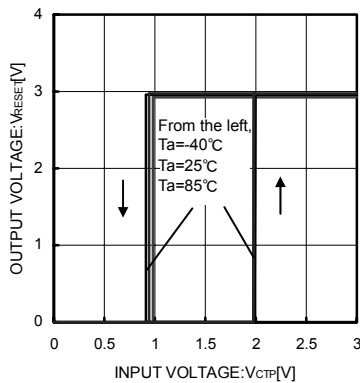

Fig.31 CTP Threshold Voltage 1 (SEL = L)

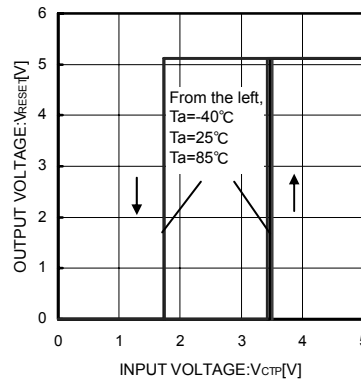

Fig.32 CTP Threshold Voltage 2 (SEL = H)

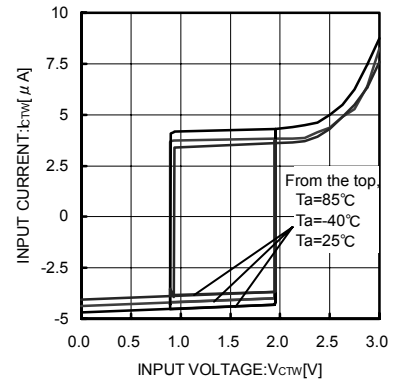

Fig.33 CTW Threshold 1 (SEL = L)

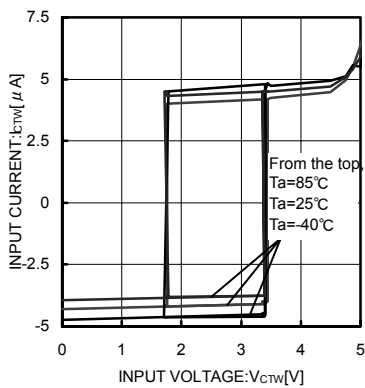

Fig.34 CTW Threshold 2 (SEL = H)

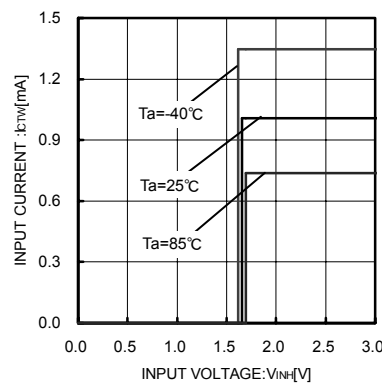

Fig.35 INH Threshold 1 (SEL = L)

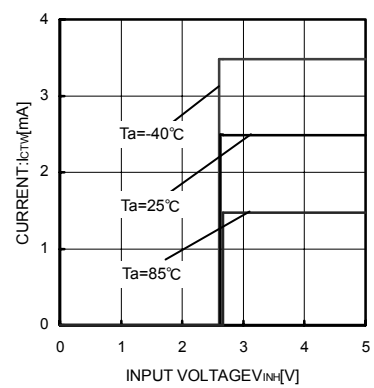

Fig.36 INH Threshold 2 (SEL = H)

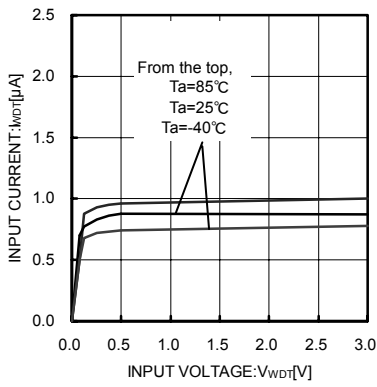

Fig.37 WDT Input Current 1 (SEL = L)

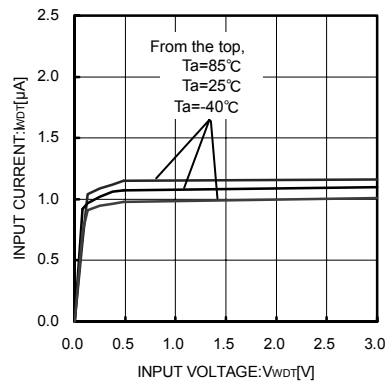

Fig.38 WDT Input Current 2 (SEL = H)

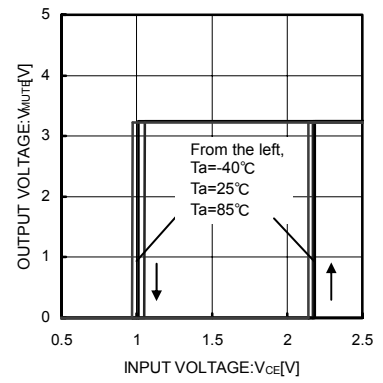

Fig.39 CE-CMP Threshold 1 (SEL = L)

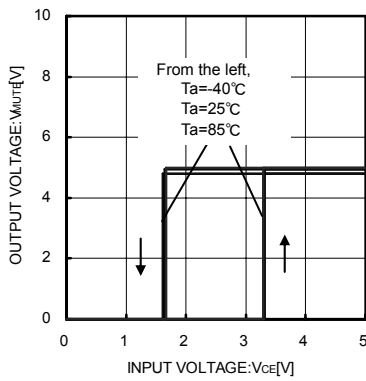

Fig.40 CE-CMP Threshold 2 (SEL = H)

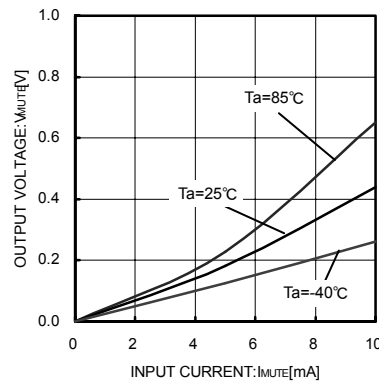

Fig.41 MUTE Output Voltage

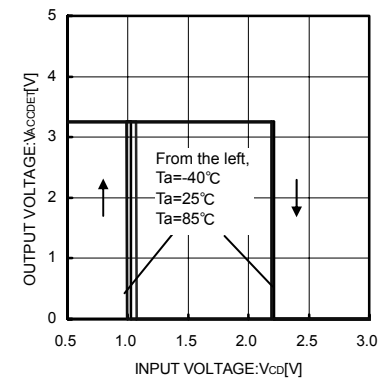

Fig.42 CD-CMP Threshold 1 (SEL = L)

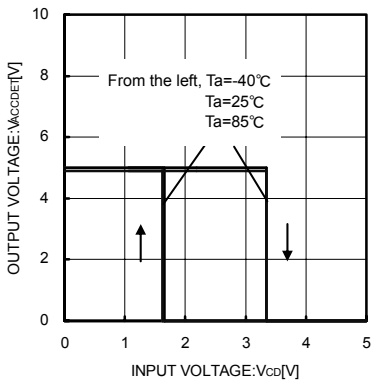

Fig.43 CD-CMP Threshold 2 (SEL = H)

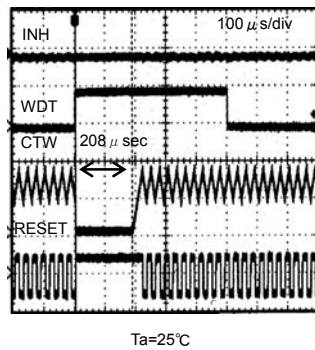

Fig.44 WDT Edge Pulse Width

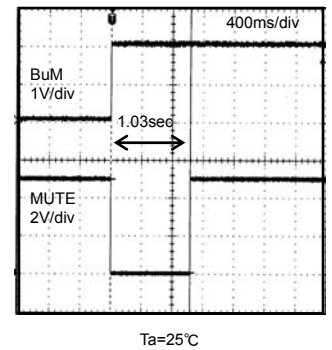

Fig.45 MUTE Timer Time (Low→High)

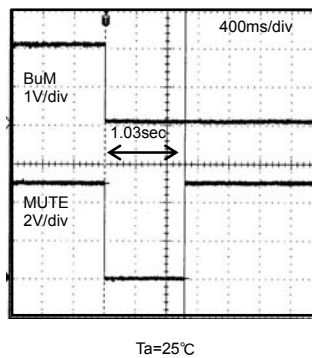

Fig.46 MUTE Timer Time (High→Low)

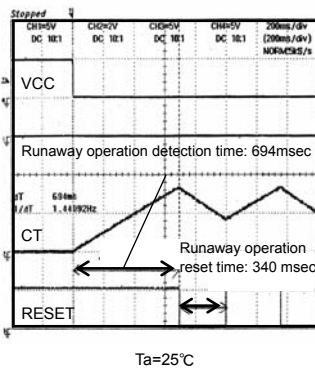

Fig.47 Runaway Operation RESET Time

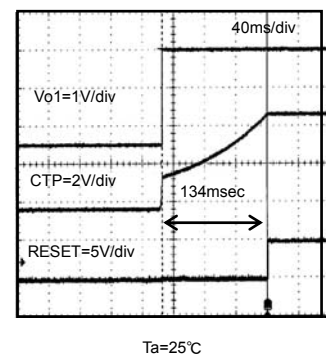

Fig.48 Power-on Reset Time

●Block diagram, IC package & timing chart

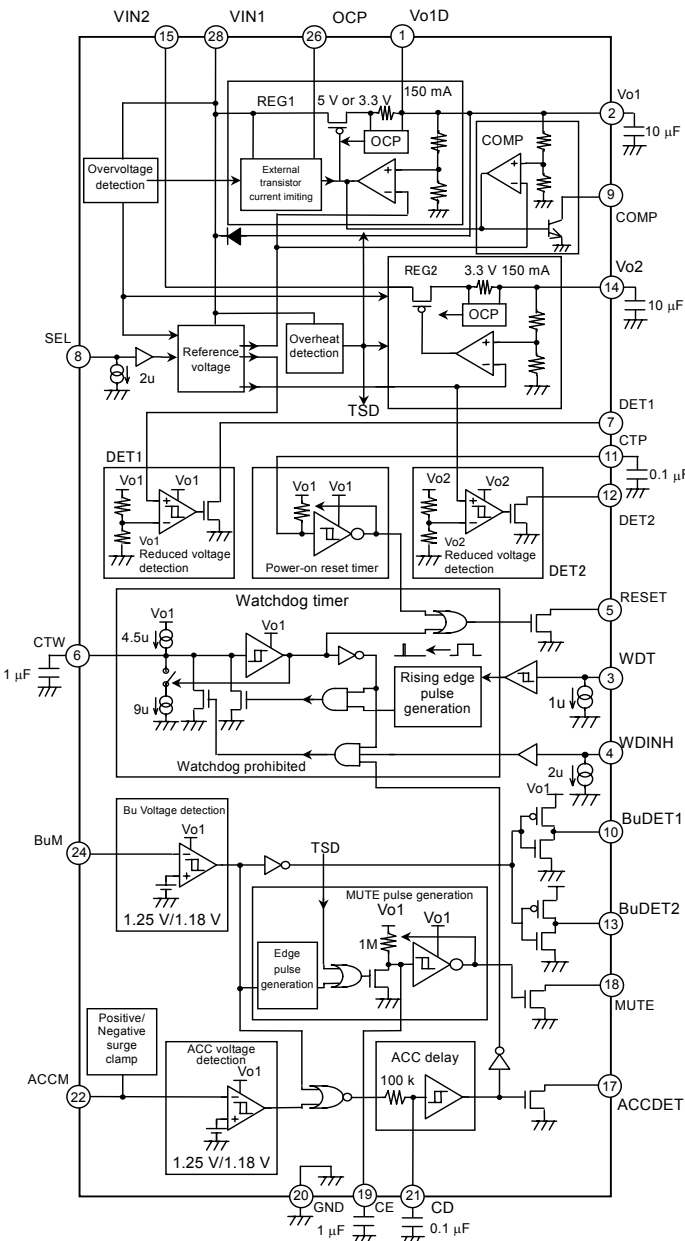

Fig.49 Block Diagram

No.	Pin name	Function
1	Vo1D	Main regulator built-in boost transistor output pin
2	Vo1	Main regulator output voltage monitor/Vo1 circuit power supply pin
3	WDT	Watchdog pulse signal input pin
4	WDINH	Watchdog prohibit signal input pin (prohibits WDT when ACC is low or WDINH is high). Reset signal output pin
5	RESET	Reset signal output pin
6	CTW	Runaway operation detection time setting capacitor connection pin
7	DET1	Vo1 reduced-voltage detection signal output pin
8	SEL	Main regulator output voltage and reduced-voltage detection voltage selection input pin
9	COMP	Elevated output detection output
10	BuDET1	+B drop detection signal output pin (Vo1 at high output)
11	CTP	Power-on reset time setting capacitor connection pin
12	DET2	Vo2 reduced-voltage detection signal output pin
13	BuDET2	+B drop detection signal output pin (Vo2 at high output)
14	Vo2	Sub-regulator output pin
15	VIN2	Sub-regulator input pin
16	N.C.	NC pin
17	ACCDET	ACC voltage detection signal output pin
18	MUTE	MUTE output pin
19	CE	MUTE pulse width setting capacitor connection pin
20	GND	GND pin
21	CD	ACCDET delay time setting capacitor connection pin
22	ACCM	Acc voltage monitor input pin
23	N.C.	NC pin
24	BuM	Battery voltage monitor input pin
25	N.C.	NC pin
26	OCP	Main regulator external boost transistor current limit setting resistance connection pin
27	N.C.	NC pin
28	VIN1	Main regulator connection pin
FIN	FIN	Heat dissipation fin (sub) (Connect to GND pin.)

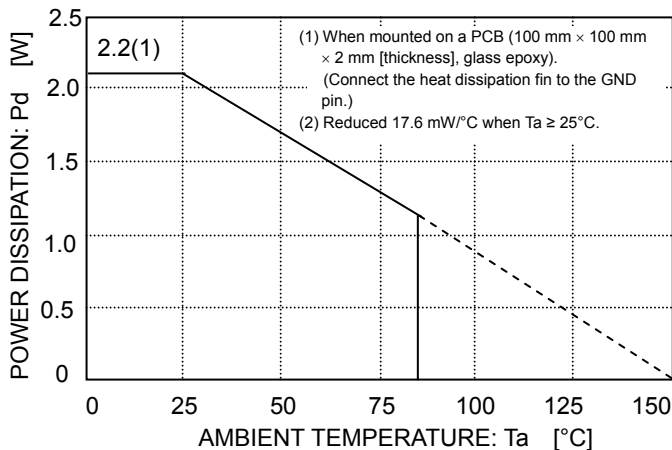
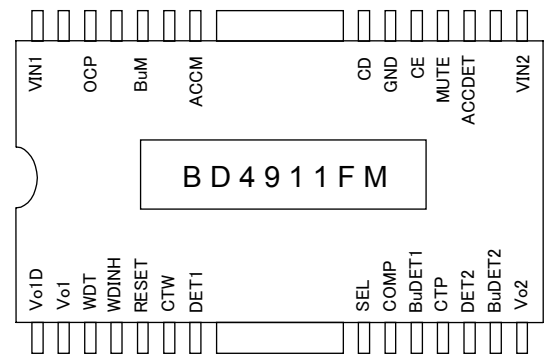

Fig.50 Power Dissipation Characteristics



UNIT: (mm)

Fig.51 Pin Assign Diagram

●Block diagram, IC package & timing chart

O I/O Timing Chart

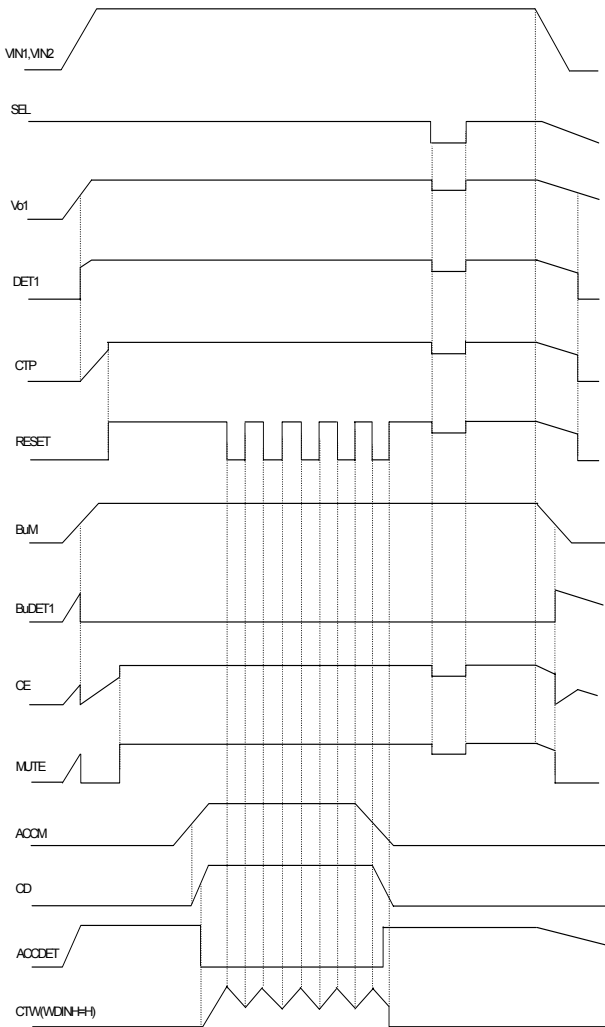

Fig.52

O Watchdog timer and runaway operation reset timing chart 1

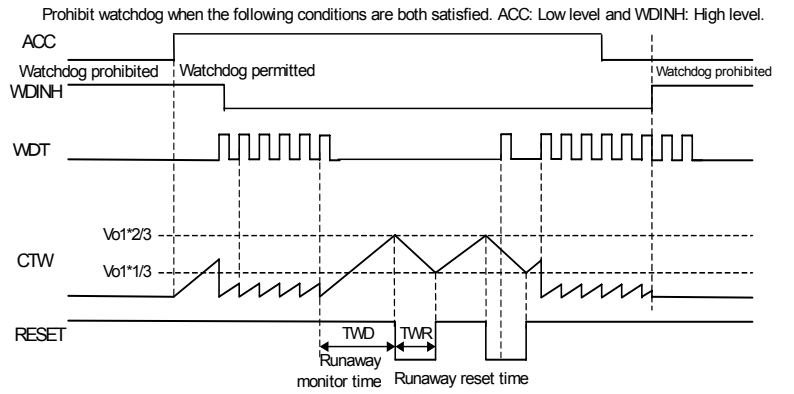

Fig.53

O Watchdog timer and runaway operation reset timing chart 2

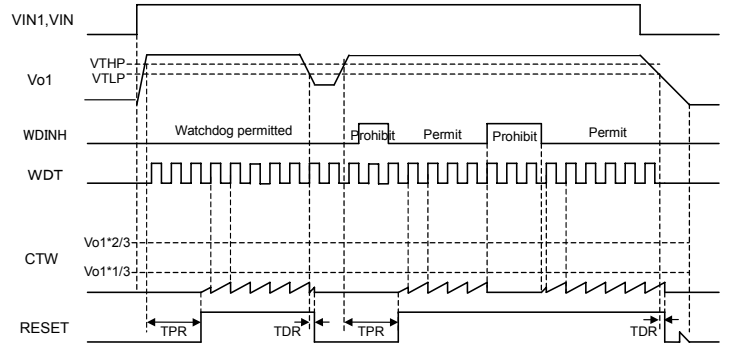

Fig.54

O Power-on reset and reduced-voltage reset timing chart

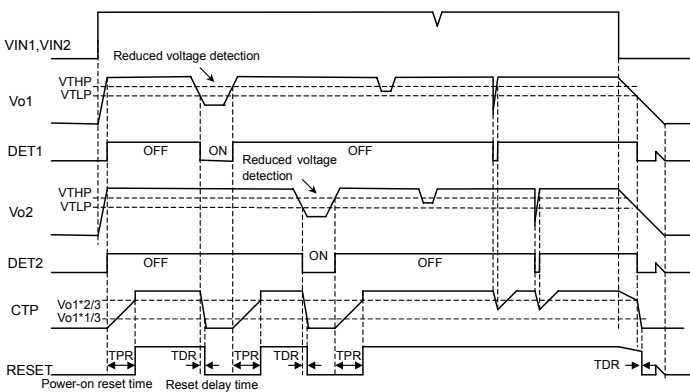

Fig.55

O BuDET1, BuDET2, ACCDET, and MUTE timing chart

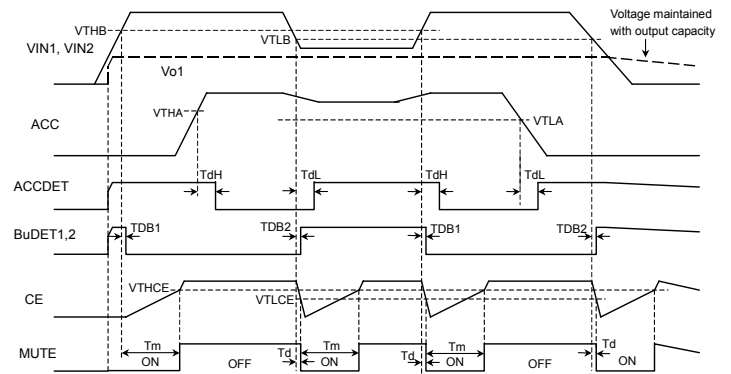

Fig.56

●Operation Notes

1. Absolute maximum ratings

An excess in the absolute maximum ratings, such as supply voltage, temperature range of operating conditions, etc., can break down the devices, thus making impossible to identify breaking mode, such as a short circuit or an open circuit. If any over rated values will expect to exceed the absolute maximum ratings, consider adding circuit protection devices, such as fuses.

2. GND voltage

The potential of GND pin must be minimum potential in all operating conditions.

3. Thermal design

Use a thermal design that allows for a sufficient margin in light of the power dissipation (Pd) in actual operating conditions.

4. Inter-pin shorts and mounting errors

Use caution when positioning the IC for mounting on printed circuit boards. The IC may be damaged if there is any connection error or if pins are shorted together.

5. Actions in strong electromagnetic field

Use caution when using the IC in the presence of a strong electromagnetic field as doing so may cause the IC to malfunction.

6. Testing on application boards

When testing the IC on an application board, connecting a capacitor to a pin with low impedance subjects the IC to stress. Always discharge capacitors after each process or step. Always turn the IC's power supply off before connecting it to or removing it from a jig or fixture during the inspection process. Ground the IC during assembly steps as an antistatic measure. Use similar precaution when transporting or storing the IC.

7. Regarding input pin of the IC

This monolithic IC contains P+ isolation and P substrate layers between adjacent elements in order to keep them isolated. P-N junctions are formed at the intersection of these P layers with the N layers of other elements, creating a parasitic diode or transistor. For example, the relation between each potential is as follows:

When $GND > Pin A$ and $GND > Pin B$, the P-N junction operates as a parasitic diode.

When $GND > Pin B$, the P-N junction operates as a parasitic transistor.

Parasitic diodes can occur inevitable in the structure of the IC. The operation of parasitic diodes can result in mutual interference among circuits, operational faults, or physical damage. Accordingly, methods by which parasitic diodes operate, such as applying a voltage that is lower than the GND (P substrate) voltage to an input pin, should not be used.

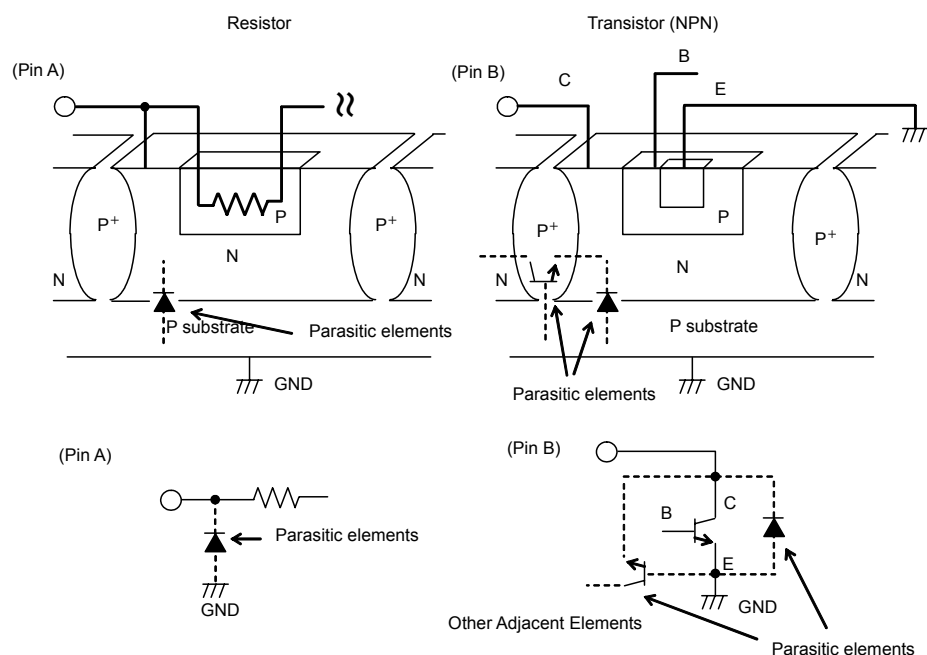

Fig.58 Example of a Simple Monolithic IC Architecture

8. Ground Wiring Pattern

When using both small signal and large current GND patterns, it is recommended to isolate the two ground patterns, placing a single ground point at the ground potential of application so that the pattern wiring resistance and voltage variations caused by large currents do not cause variations in the small signal ground voltage. Be careful not to change the GND wiring pattern of any external components, either.

9. Recommended operating ranges

Proper circuit functionality is guaranteed within the operating temperature range for power supply voltages that fall within the recommended ranges.

Although standard electrical characteristics values are not guaranteed, characteristics values will not vary suddenly within these ranges.

10. Output capacitors

Capacitors for stopping oscillation must be placed between each output pin and the GND pin.

It is recommended to use a 10 μF ceramic capacitor (B characteristics). When using an external boost transistor, the ceramic capacitor described above should be connected in series with a 1 Ω resistor. Abrupt input voltage and load fluctuations can affect output voltages. Output capacitor capacitance values should be determined after sufficient testing of the actual application.

11. Applications or inspection processes with modes where the potentials of the VIN pin and other pins may be reversed from their normal states may cause damage to the IC's internal circuitry or elements. For example, such damage might occur when VIN is shorted with the GND pin while an external capacitor is charged. Use capacitors that fall within the range listed for each pin in Table 1. It is recommended to insert a diode to prevent back current flow in series with VIN, or bypass diodes between VIN and each pin. If the VIN pin carries a lower voltage than the GND pin, insert a protective diode between the VIN and GND pins.

Output pin	Output capacitor
Vo1	10 μF to 2200 μF
Vo2	10 μF to 2200 μF

Table 1

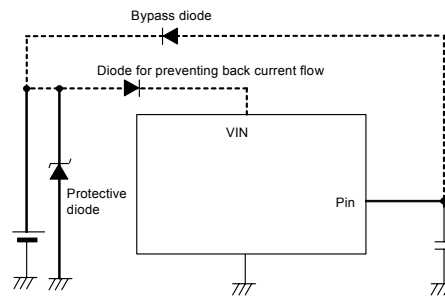

Fig.59

12. Overcurrent protection circuits

The IC incorporates a built-in overcurrent protection circuit for each output pin. Each circuit is specifically designed for the current capacity of the corresponding pin and acts to prevent damage to the IC when an overcurrent flows.

The protection circuits use drooping type current limiting (when using the built-in transistor) or drooping fold-back type current limiting (when using the external boost transistor). They are designed to limit current flow by not latching up in the event of a large and instantaneous current flow originating from a large capacitor or other component. Their design allows for sufficient safety margins. These protection circuits are effective in preventing damage due to sudden and unexpected accidents. However, the IC should not be used in applications characterized by the continuous operation or transitioning of the protection circuits (for example, applications where the IC is continuously connected to a load that significantly exceeds the output current capacity).

Use caution regarding thermal design, as the output current capacity varies negatively with the temperature characteristics.

13. Overvoltage protection circuit

Overvoltage protection is designed to turn off all output voltages when the voltage differential between the VIN and GND pins exceeds approximately 31 V (at room temperature). Use caution when determining the power supply voltage range to use.

14. Thermal shutdown circuit (TSD)

This IC incorporates a built-in thermal shutdown circuit for the protection from thermal destruction. The IC should be used within the specified power dissipation range. However, in the event that the IC continues to be operated in excess of its power dissipation limits, the attendant rise in the chip's temperature T_j will trigger the thermal shutdown circuit to turn off all output power elements. The circuit will automatically reset once the chip's temperature T_j drops.

Operation of the thermal shutdown circuit presumes that the IC's absolute maximum ratings have been exceeded.

Application designs should never make use of the thermal shutdown circuit.

15. Ground precautions

Pattern routes connecting the ground points, indicated in application circuits example, to the GND pin should be sufficiently short and should be positioned to avoid electrical interference.

16. Bypass capacitor between the VIN and GND pins

It is recommended to insert a 0.47 μF to 10 mF bypass capacitor between the VIN and GND pins. Capacitance values vary with application. Capacitors should be tested in actual implementations, and designs should allow for sufficient margins.

Failure to use the optimum capacitance value may lead to output oscillation and other issues.

17. Applications with modes where the potentials of the input pins (VIN1, VIN2) and GND pins and other output pins may be reversed from their normal states may cause damage to the IC's internal circuitry. In particular, it is recommended to create a bypass route with diodes or other components when loads including large inductance components are connected where BEMF may be generated during startup or when output is turned off.

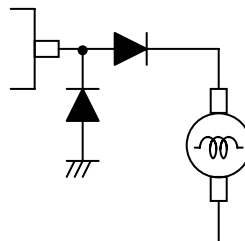
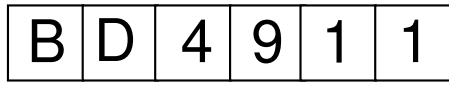

Fig.60

18. Always verify the characteristics of example application circuits prior to their use. When changing other external circuit constants, allow for sufficient margins after considering the variability of both the ROHM IC and external components, including both static and transient characteristics.

●Selecting a model name when ordering



Part number
BD4911



Package type
FM: HSOPM28



Taping type
E2 = Reel-wound embossed taping
(HSOPM28)

HSOP-M28

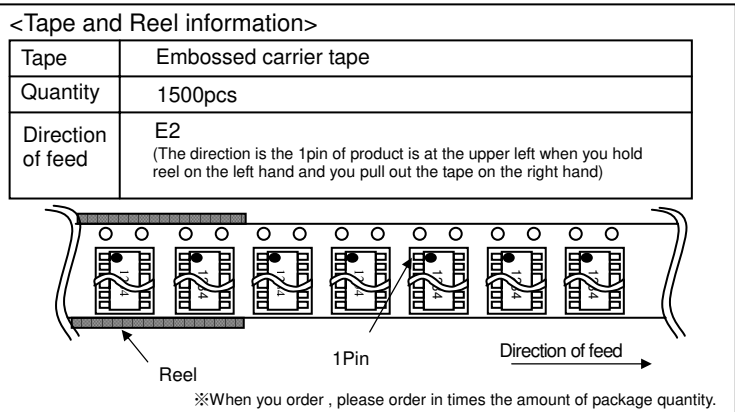
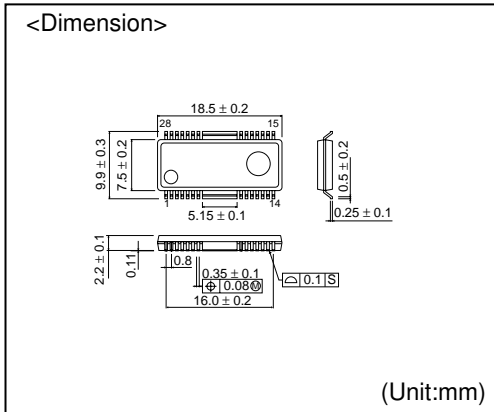

- The contents described herein are correct as of October, 2005
- The contents described herein are subject to change without notice. For updates of the latest information, please contact and confirm with ROHM CO.,LTD.
- Any part of this application note must not be duplicated or copied without our permission.
- Application circuit diagrams and circuit constants contained herein are shown as examples of standard use and operation. Please pay careful attention to the peripheral conditions when designing circuits and deciding upon circuit constants in the set.
- Any data, including, but not limited to application circuit diagrams and information, described herein are intended only as illustrations of such devices and not as the specifications for such devices. ROHM CO.,LTD. disclaims any warranty that any use of such devices shall be free from infringement of any third party's intellectual property rights or other proprietary rights, and further, assumes no liability of whatsoever nature in the event of any such infringement, or arising from or connected with or related to the use of such devices.
- Upon the sale of any such devices, other than for buyer's right to use such devices itself, resell or otherwise dispose of the same, implied right or license to practice or commercially exploit any intellectual property rights or other proprietary rights owned or controlled by ROHM CO., LTD. is granted to any such buyer.
- The products described herein utilize silicon as the main material.
- The products described herein are not designed to be X ray proof.

The products listed in this catalog are designed to be used with ordinary electronic equipment or devices (such as audio visual equipment, office-automation equipment, communications devices, electrical appliances and electronic toys). Should you intend to use these products with equipment or devices which require an extremely high level of reliability and the malfunction of which would directly endanger human life (such as medical instruments, transportation equipment, aerospace machinery, nuclear-reactor controllers, fuel controllers and other safety devices), please be sure to consult with our sales representative in advance.

Excellence in Electronics



ROHM CO., LTD.

21, Saiin Mizosaki-cho, Ukyo-ku, Kyoto
615-8585, Japan
TEL: (075)311-2121 FAX: (075)315-0172
URL <http://www.rohm.com>

Published by
Application Engineering Group

Contact us for further information about the products.

- Atlanta U.S.A. / ROHM ELECTRONICS ATLANTA SALES OFFICE
(DIVISION OF ROHM ELE. U.S.A.,LLC)
TEL: +1(770)754-5972 FAX: +1(770)754-0691
- Dallas U.S.A. / ROHM ELECTRONICS DALLAS SALES OFFICE
(DIVISION OF ROHM ELE. U.S.A.,LLC)
TEL: +1(972)312-8818 FAX: +1(972)312-0330
- San Diego U.S.A. / ROHM ELECTRONICS SAN DIEGO SALES OFFICE
(DIVISION OF ROHM ELE. U.S.A.,LLC)
TEL: +1(858)625-3630 FAX: +1(858)625-3670
- Germany / ROHM ELECTRONICS GMBH (GERMANY)
TEL: +49(2154)9210 FAX: +49(2154)921400
- United Kingdom / ROHM ELECTRONICS GMBH (UK)
TEL: +44(0)1908-306700 FAX: +44(0)1908-235788
- France / ROHM ELECTRONICS GMBH (FRANCE)
TEL: +33(0)1 56 97 30 60 FAX: +33(0)1 56 97 30 80
- Hong Kong China / ROHM ELECTRONICS (H.K.) CO., LTD.
TEL: +852(2174)0622 FAX: +852(2137)5-8971
- Shanghai China / ROHM ELECTRONICS (SHANGHAI) CO., LTD.
TEL: +86(21)6279-2727 FAX: +86(21)6247-2066
- Dalian China / ROHM ELECTRONICS TRADING (DALIAN) CO., LTD.
TEL: +86(411)8230-8549 FAX: +86(411)8230-8537

- Beijing China / BEIJING REPRESENTATIVE OFFICE
TEL: +86(10)8525-2483 FAX: +86(10)8525-2489
- Taiwan / ROHM ELECTRONICS TAIWAN CO., LTD.
TEL: +886(2)2500-6936 FAX: +886(2)2503-2869
- Korea / ROHM ELECTRONICS KOREA CORPORATION
TEL: +82(2)8182-7000 FAX: +82(2)8182-715
- Singapore / ROHM ELECTRONICS ASIA PTE. LTD. (RES/REI)
TEL: +65-6332-2322 FAX: +65-6332-5662
- Malaysia / ROHM ELECTRONICS (MALAYSIA) SDN. BHD.
TEL: +60(3)7959-8355 FAX: +60(3)7959-8377
- Philippines / ROHM ELECTRONICS (PHILIPPINES) SALES CORPORATION
TEL: +63(2)807-6872 FAX: +63(2)809-1422
- Thailand / ROHM ELECTRONICS (THAILAND) CO., LTD.
TEL: +66(2)254-4890 FAX: +66(2)256-6334

Notes

- No technical content pages of this document may be reproduced in any form or transmitted by any means without prior permission of ROHM CO.,LTD.
- The contents described herein are subject to change without notice. The specifications for the product described in this document are for reference only. Upon actual use, therefore, please request that specifications to be separately delivered.
- Application circuit diagrams and circuit constants contained herein are shown as examples of standard use and operation. Please pay careful attention to the peripheral conditions when designing circuits and deciding upon circuit constants in the set.
- Any data, including, but not limited to application circuit diagrams information, described herein are intended only as illustrations of such devices and not as the specifications for such devices. ROHM CO.,LTD. disclaims any warranty that any use of such devices shall be free from infringement of any third party's intellectual property rights or other proprietary rights, and further, assumes no liability of whatsoever nature in the event of any such infringement, or arising from or connected with or related to the use of such devices.
- Upon the sale of any such devices, other than for buyer's right to use such devices itself, resell or otherwise dispose of the same, no express or implied right or license to practice or commercially exploit any intellectual property rights or other proprietary rights owned or controlled by
- ROHM CO., LTD. is granted to any such buyer.
- Products listed in this document are no antiradiation design.

The products listed in this document are designed to be used with ordinary electronic equipment or devices (such as audio visual equipment, office-automation equipment, communications devices, electrical appliances and electronic toys).

Should you intend to use these products with equipment or devices which require an extremely high level of reliability and the malfunction of which would directly endanger human life (such as medical instruments, transportation equipment, aerospace machinery, nuclear-reactor controllers, fuel controllers and other safety devices), please be sure to consult with our sales representative in advance.

It is our top priority to supply products with the utmost quality and reliability. However, there is always a chance of failure due to unexpected factors. Therefore, please take into account the derating characteristics and allow for sufficient safety features, such as extra margin, anti-flammability, and fail-safe measures when designing in order to prevent possible accidents that may result in bodily harm or fire caused by component failure. ROHM cannot be held responsible for any damages arising from the use of the products under conditions out of the range of the specifications or due to non-compliance with the NOTES specified in this catalog.

Thank you for your accessing to ROHM product informations.

More detail product informations and catalogs are available, please contact your nearest sales office.

ROHM Customer Support System

THE AMERICAS / EUROPE / ASIA / JAPAN

www.rohm.com

Contact us : webmaster@rohm.co.jp