

EAHP1215WA2



Features

- LM-80 Certified
- High Power COB & High CRI LED
- Multi-Chip Solution
- Dimension: 12 mm x 15 mm x 1.6 mm
- Main Parameters: Luminous Flux, Forward Voltage, Chromaticity and Color Rendering Index
- RoHS compliant
- Energy Star / ANSI Compliant Binning Structure
- Typical Viewing Angle: 115°

Description

Everlight Americas EAHP1215WA2 is a ceramic substrate based LED achieving high efficiency while maintaining high CRI at Energy Star / ANSI color temperature ranges.

Applications

- Replacement Bulb
- Indoor General Lighting
- Recessed Can Lighting

Absolute Maximum Ratings

| Parameter | Symbol | Ratings | Unit |
|---------------------------------------|-------------|--------------------|------|
| Max. DC Forward Current (mA) | I_F | 750 _[1] | mA |
| Max. Peak Pulse Current (mA) | I_{Pulse} | 800 _[2] | mA |
| Power Dissipation | P_d | 7 | W |
| Thermal Resistance(junction to board) | R_{th} | 3.6 | °C/W |
| Max. Junction Temperature | T_J | 115 | °C |
| Operating Temperature | T_{Opr} | -40 ~ +85 | °C |
| Storage Temperature | T_{Stg} | -40 ~ +85 | °C |

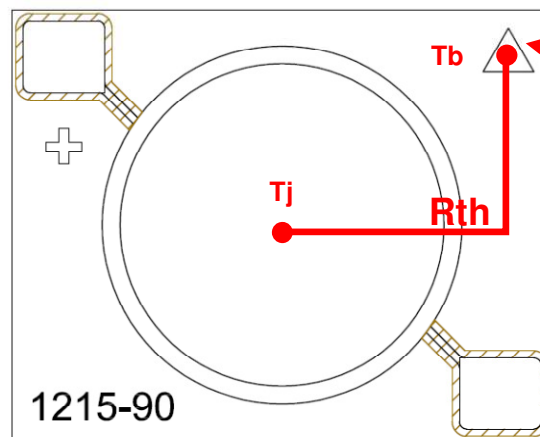

Measuring point for
board temperature

Notes:

1. For optimal performance, Everlight Americas recommends 550mA operation.
2. $t_p \leq 100ms$, Duty cycle = 25%
3. The EAHP1215WA2 LEDs are not designed for reverse bias use.

PN of the EAHP1215WA2: White LEDs



| Order Code of EAHP1215WA2 | Minimum Luminous Flux (lm) @T _j =25°C | Typical Luminous Flux (lm) @T _j =25°C | Typical Luminous Flux (lm) @T _j =85°C | CCT (K) | Forward Voltage (V) | Forward Current (mA) | CRI (min.) |
|---------------------------|--|--|--|-------------|---------------------|----------------------|------------|
| EAHP1215WA2 | 650 | 710 | 643 | 27K-1~27K-4 | 11.0~14.0 | 550 | 80 |

Notes:

1. CRI measurement tolerance: ±2.
2. Luminous flux measurement tolerance: ±10%.
3. The values of luminous flux @ T_j=85°C are calculated and for reference only.
4. Typical luminous flux or light output performance is operated within the condition guided by this datasheet.

Product Binning

Luminous Flux Bins

| Group | Bin | Minimum Photometric Flux (lm) | Maximum Photometric Flux (lm) |
|-------|-----|-------------------------------|-------------------------------|
| E | 1 | 4 | 5 |
| | 2 | 5 | 6 |
| | 3 | 6 | 8 |
| | 4 | 8 | 10 |
| | 5 | 10 | 13 |
| | 6 | 13 | 17 |
| | 7 | 17 | 20 |
| | 8 | 20 | 23 |
| | 9 | 23 | 27 |
| F | 1 | 27 | 33 |
| | 2 | 33 | 39 |
| | 3 | 39 | 45 |
| | 4 | 45 | 52 |
| | 5 | 52 | 60 |
| | 6 | 60 | 70 |
| | 7 | 70 | 80 |
| | 8 | 80 | 90 |
| | 9 | 90 | 100 |

| Group | Bin | Minimum Photometric Flux (lm) | Maximum Photometric Flux (lm) |
|-------|-----|-------------------------------|-------------------------------|
| J | 1 | 100 | 110 |
| | 2 | 110 | 120 |
| | 3 | 120 | 130 |
| | 4 | 130 | 140 |
| | 5 | 140 | 150 |
| | 6 | 150 | 160 |
| | 7 | 160 | 180 |
| | 8 | 180 | 200 |
| | 9 | 200 | 225 |
| K | 1 | 225 | 250 |
| | 2 | 250 | 275 |
| | 3 | 275 | 300 |
| | 4 | 300 | 325 |
| | 5 | 325 | 350 |
| | 6 | 350 | 375 |
| | 7 | 375 | 400 |
| | 8 | 400 | 425 |
| | 9 | 425 | 450 |
| N | 1 | 450 | 475 |
| | 2 | 475 | 500 |
| | 3 | 500 | 550 |
| | 4 | 550 | 600 |
| | 5 | 600 | 650 |
| | 6 | 650 | 700 |
| | 7 | 700 | 750 |
| | 8 | 750 | 800 |
| | 9 | 800 | 900 |

White Bin Structure

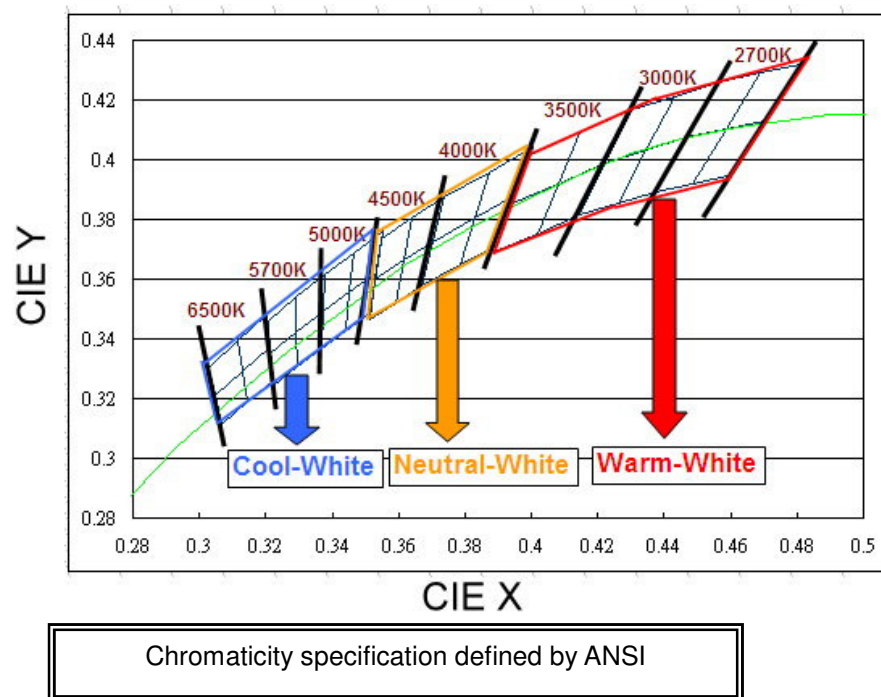

Notes:

1. The CCT range of Cool-White varies from 4745K to 7050K.
2. The CCT range of Neutral-White varies from 3710K to 4745K.
3. The CCT range of Warm-White varies from 2580K to 3710K
4. Color coordinates measurement allowance : ± 0.01
5. Color bins are defined at $I_f=550\text{mA}$ operation

Warm-White Bin Structure

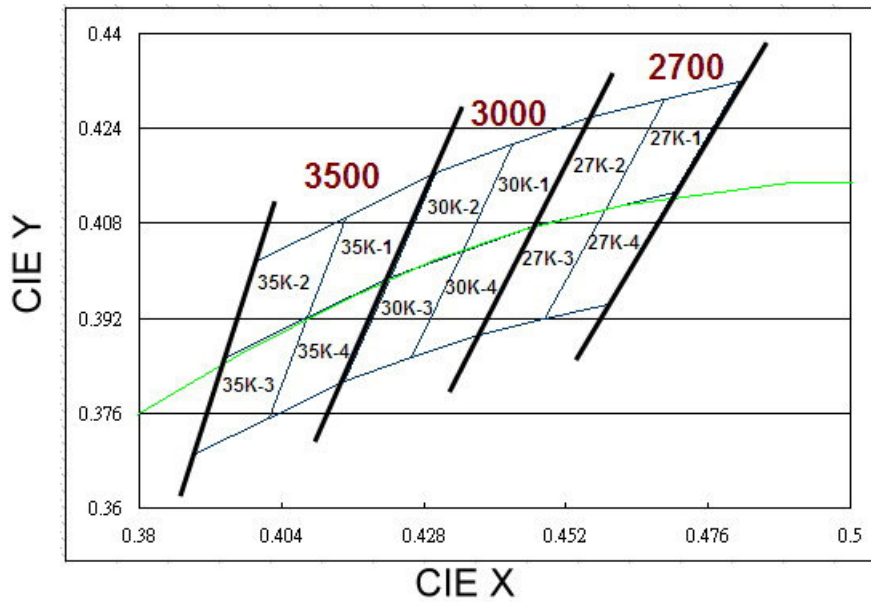

Warm-White Bin Coordinates

2700K

| Bin | CIE X | CIE Y |
|-----------------------------|-------|-------|
| 27K-1 | 0.469 | 0.429 |
| | 0.459 | 0.410 |
| | 0.470 | 0.413 |
| | 0.481 | 0.432 |
| Reference Range: 2580~2700K | | |

| Bin | CIE X | CIE Y |
|-----------------------------|-------|-------|
| 27K-2 | 0.456 | 0.426 |
| | 0.447 | 0.408 |
| | 0.459 | 0.410 |
| | 0.469 | 0.429 |
| Reference Range: 2700~2870K | | |

| Bin | CIE X | CIE Y |
|-----------------------------|-------|-------|
| 27K-4 | 0.459 | 0.410 |
| | 0.448 | 0.392 |
| | 0.459 | 0.394 |
| | 0.470 | 0.413 |
| Reference Range: 2580~2700K | | |

| Bin | CIE X | CIE Y |
|-----------------------------|-------|-------|
| 27K-3 | 0.447 | 0.408 |
| | 0.437 | 0.389 |
| | 0.448 | 0.392 |
| | 0.459 | 0.410 |
| Reference Range: 2700~2870K | | |

Notes:

1. Color coordinates measurement allowance : ± 0.01

Forward Voltage Bins

| Bin | Minimum Forward Voltage (V) | Maximum Forward Voltage (V) |
|-----|-----------------------------|-----------------------------|
| R3 | 11.0 | 12.0 |
| R4 | 12.0 | 13.0 |
| R5 | 13.0 | 14.0 |

Notes:

1. Forward voltage measurement tolerance: $\pm 2\%$.
2. Forward voltage bins are defined at $I_f=550\text{mA}$ operation.
3. Other Forward Voltage bins for White LEDs available upon request. Please contact your local Everlight Americas sales office.

Mechanical Dimension

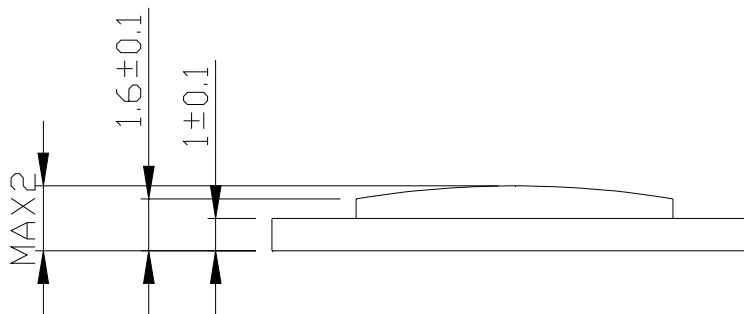
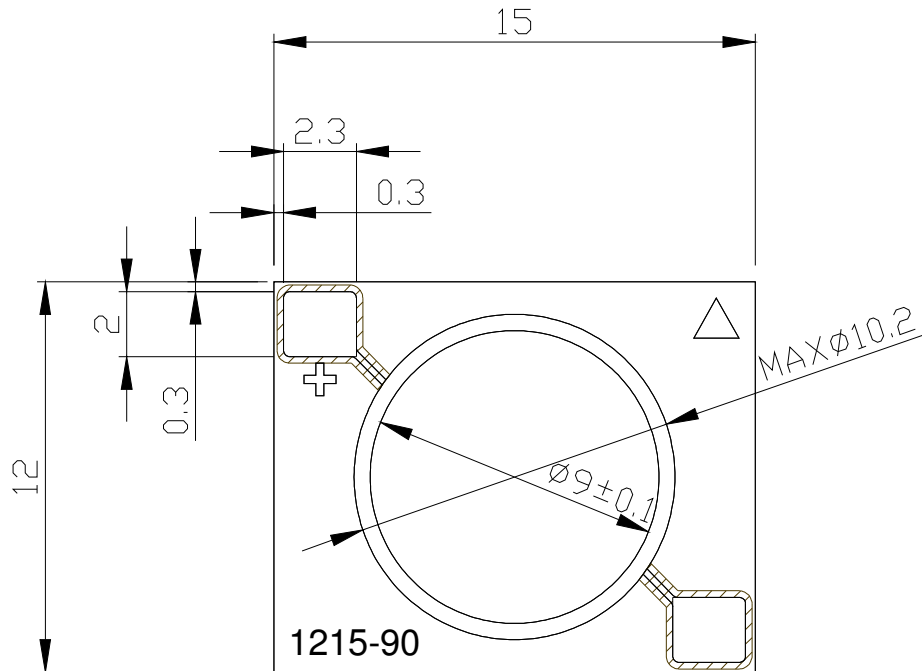

 4 series × 5 parallel

Note:

1. Dimensions are in millimeters.
2. Tolerances unless mentioned are ± 0.1 mm.

Pad Configuration

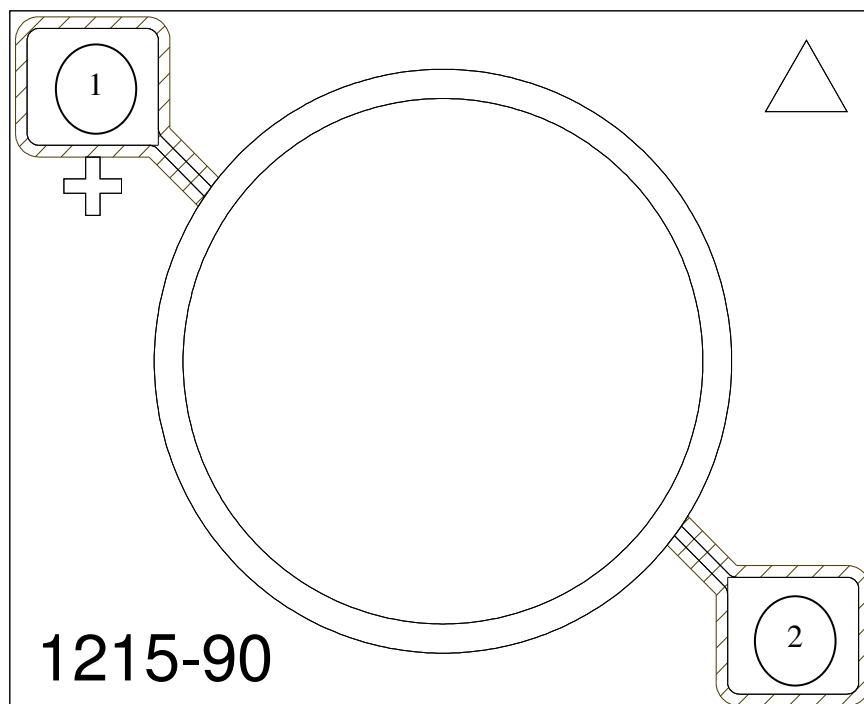

| PAD | FUNCTION |
|-----|----------|
| 1 | ANODE |
| 2 | CATHODE |

Typical Electro-Optical Characteristic Curve

Relative Spectral Distribution
@ Substrate Temperature = 25°C

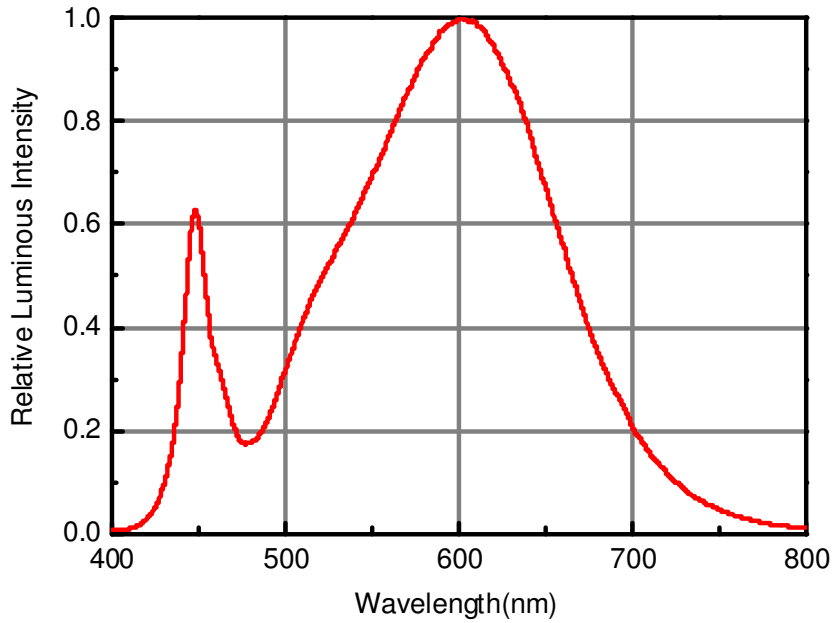

Relative Luminous Flux vs. Substrate Temperature
@Forward Current = 550mA

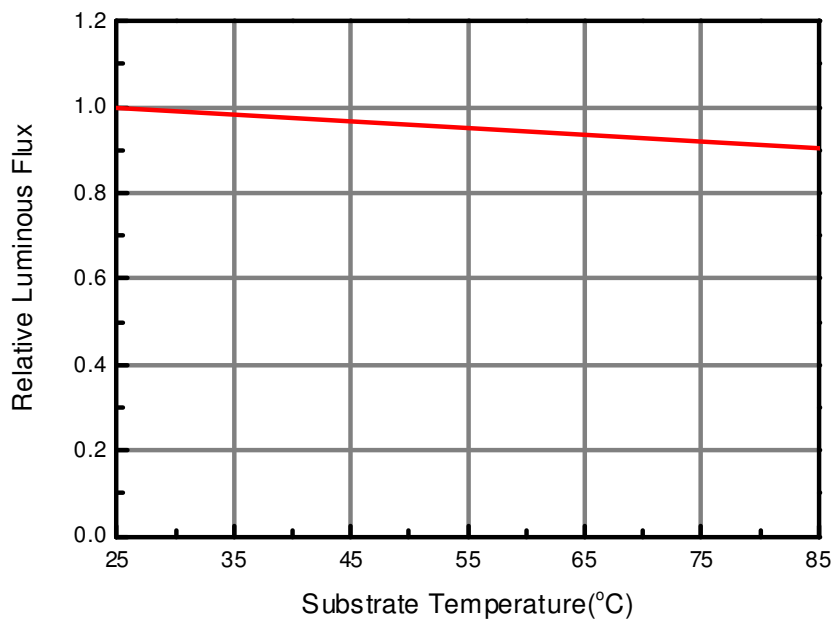

Forward Voltage vs. Forward Current @ Substrate Temperature = 25°C

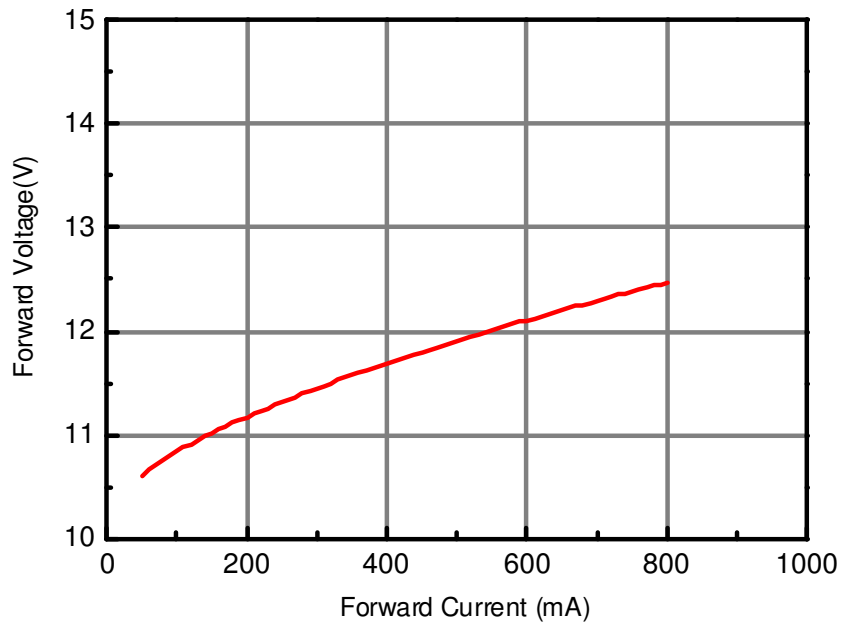

Relative Luminous Flux vs. Forward Current @ Substrate Temperature = 25°C

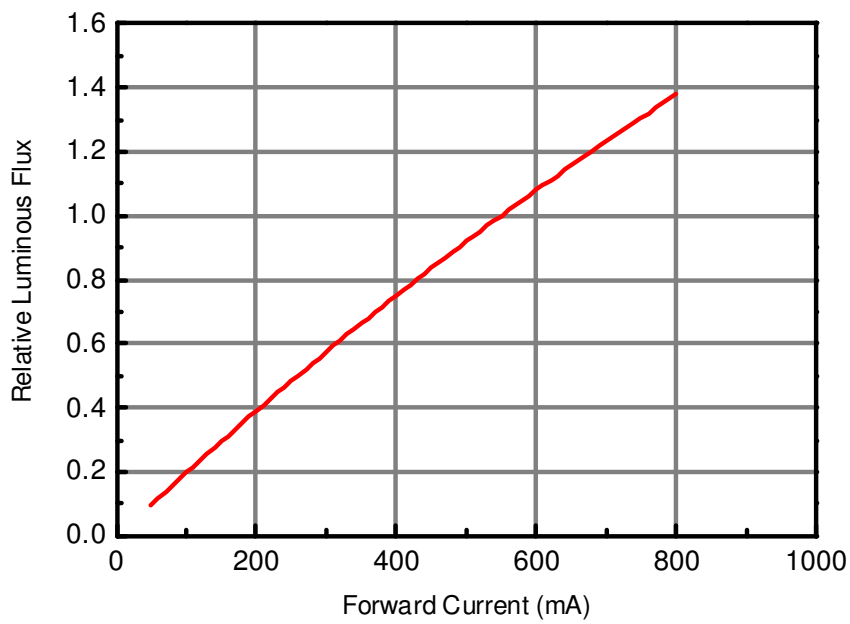

Correlated Color Temperature vs. Forward Current @ Substrate Temperature = 25°C

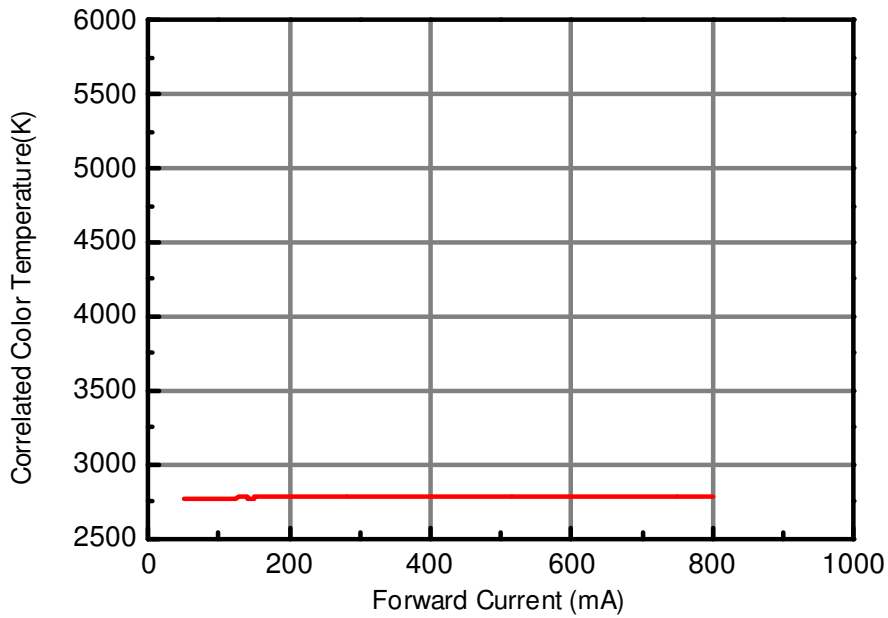

Correlated Color Temperature vs. Substrate Temperature @ Forward Current = 550mA

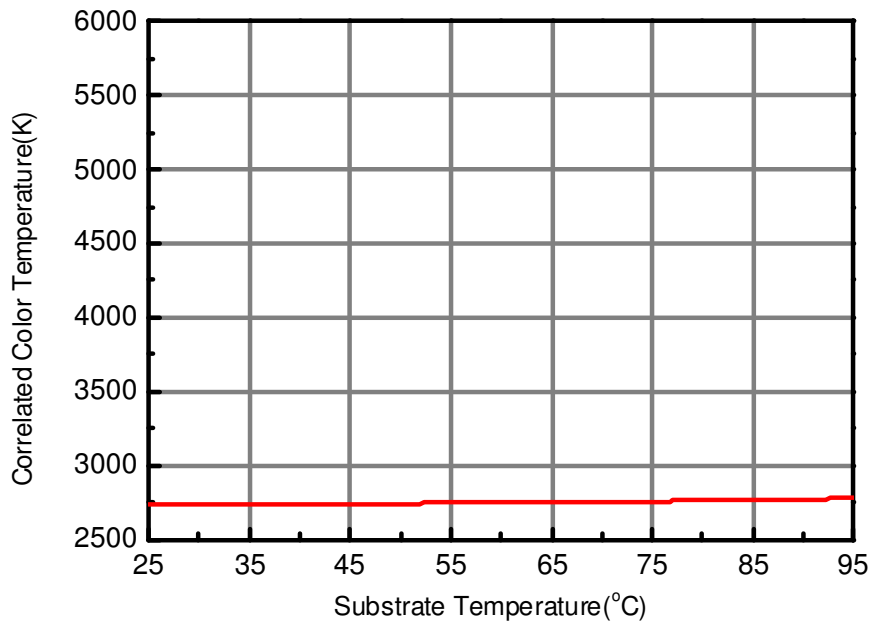

Forward Voltage vs. Substrate Temperature @ Forward Current = 550mA

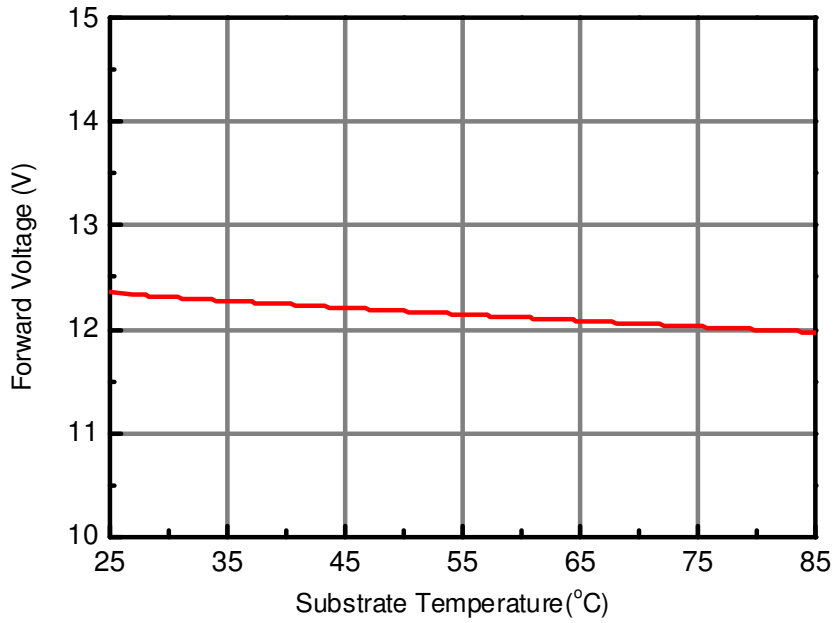

Forward Current Derating Curve @ Junction Temperature <115°C

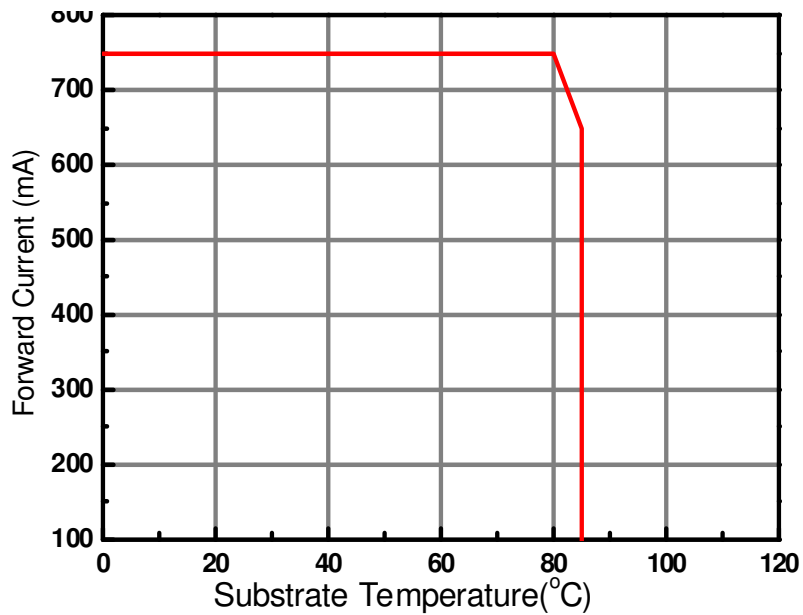

Typical Diagram Characteristics of Radiation Patterns

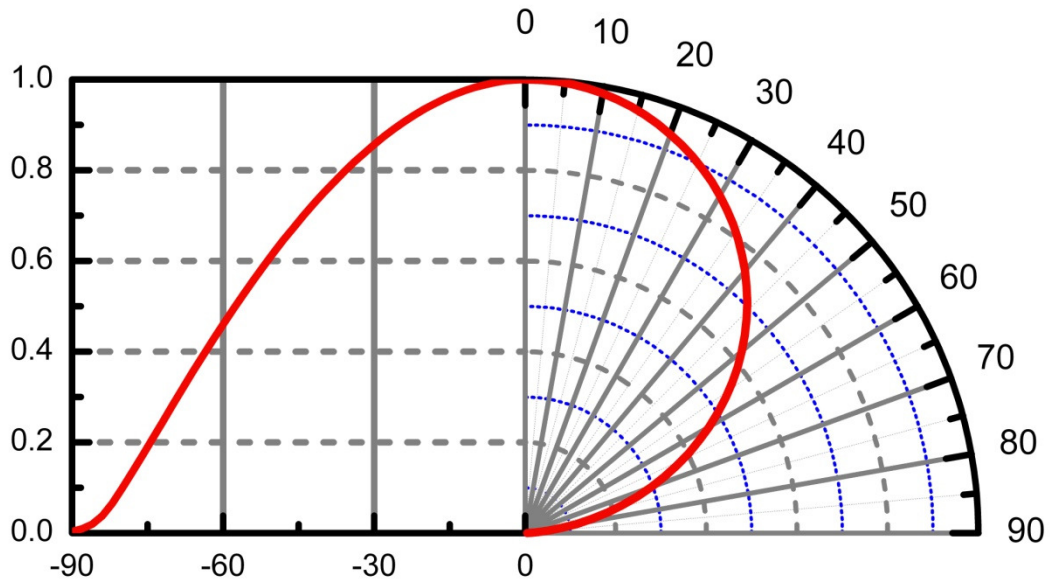

Notes:

1. $2\theta_{1/2}$ is the off axis angle from lamp centerline where the luminous intensity is 1/2 of the peak value.
2. Viewing angle tolerance is $\pm 5^\circ$.

Product Labeling

Label Explanation

CPN: Customer Specification (when required)

P/N : Everlight Americas Production Number

QTY: Packing Quantity

CAT: Luminous Flux (Brightness) Bin

HUE: Color Bin

REF: Forward Voltage Bin

LOT No: Lot Number

MADE IN TAIWAN: Production Place

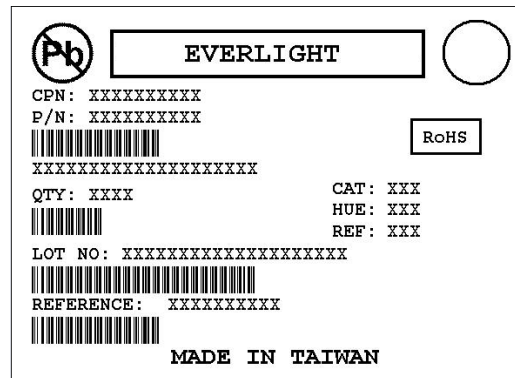

Carrier Tray Specification

Loaded Quantity: 100 PCS Per Tray

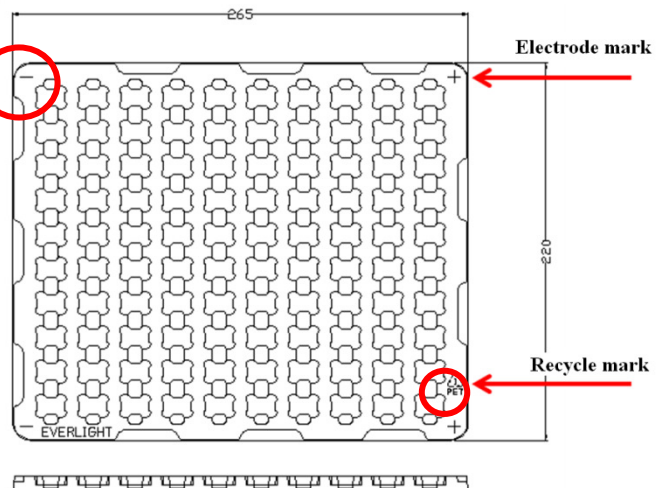

Notes:

1. Dimensions are in millimeters.
2. Tolerances unless mentioned are ± 0.1 mm

LED Direction

- The **Recycle mark** on the LEDs will be toward the **Anode mark** on the carrier tray.

Moisture Resistant Packaging



Outside Carton

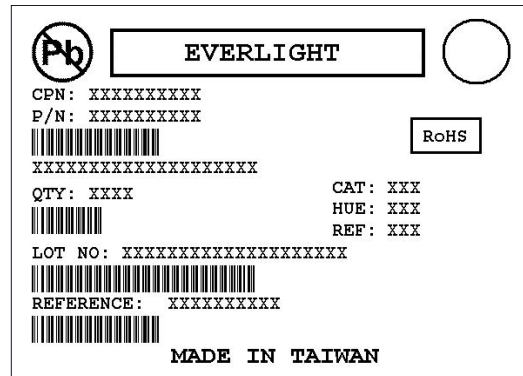
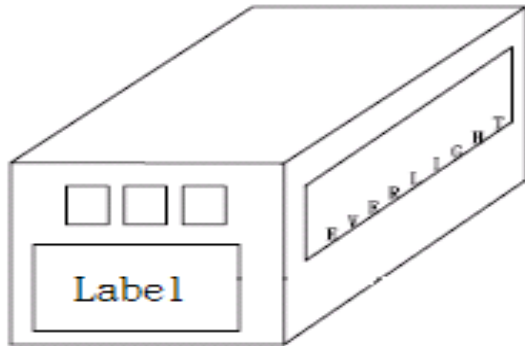

Packaging Quantity

- 100 PCS Per Tray 10 Trays Per Outside Carton

Precautions of Use

Over-Current-Proof

- Though the EAHP1215WA2 has a conducted ESD protection mechanism, customers must not use the device in reverse and should apply resistors for extra protection. Otherwise slight voltage shift may cause significant current changes and burn out failure may happen.

Storage Conditions

- Before the package is opened: The LEDs should be stored at 30°C or less and 50%RH or less after being shipped from Everlight Americas and the storage life limit is 6 months. If the LEDs are stored for 6 months or more, they should be stored in a sealed container with a nitrogen atmosphere and moisture absorbent material.
- After opening the package: The LED should be stored under 30°C or less and 30%RH or less. The LED should be used within 168hrs (7days) after opening the package. If unused LEDs remain, it should be stored in moisture proof packages.
- Do not stack assemblies.



Handling

- Do not put mechanical stress on the LED.
- Never touch the optical surface with finger or sharp object. The LED surface could be soiled or damaged, which could affect the optical performance of the LED.
- In low-humidity work environment, please keep handling the LEDs with appropriate ESD grounding.
- It is recommended to handle the LED with powder-less latex gloves.

Manual Handling

- When handling the product, do not apply direct pressure on the optical surface.
- Do not touch the resin with tweezers to avoid scratching or other damage.



Thermal Management

- Sufficient thermal management must be implemented. Substrate of the positive in temperature must be kept under 105°C at the driving current of 550mA. Otherwise, the junction temperature of die may exceed the limit at high current driving conditions and the LEDs' lifetime may be decrease dramatically.

LM-80 Test Reprot



Report No.: OA-2012-90024

Page 1 of 40

Issued: Jun. 25, 2013

TEST REPORT

The following tested product(s) were submitted and identified by the vendor as:

Applicant : EVERLIGHT ELECTRONICS CO., LTD.
 Address of Applicant : No.8-8, Zhonghua Rd., Shulin Dist, New Taipei City
 23860, Taiwan, R.O.C.
 Testing Laboratory : SGS Taiwan Ltd., Optics Laboratory
 Laboratory Address : 33, Wu Chyuan Rd., New Taipei Industrial Park, New
 Taipei City, Taiwan 24886
 Product Name : LED Component JU1215 12 V / 7 W COB series
 Model / Serial Number : JU1215-KM307N6-12507-090T
 Manufacturer : EVERLIGHT ELECTRONICS CO., LTD.
 Rating : DC 550 mA, 11 V to 14 V
 Tested Condition : DC 600 mA (Constant Current)
 Test Standard/Method : IES LM-80-08 Approved Method: Measuring Lumen
 Maintenance of LED Light Sources
 Date of Issue : Jun. 25, 2013

The submitted products have been tested as requested and the following results were obtained, and the report, not applicable for lawsuit, refers only to the unit(s) submitted for test.

Test Results : -PLEASE SEE ATTACHED SHEETS-

Signed for and on behalf of
SGS TAIWAN Ltd.

Calvin Tzou
Technical Manager

Unless otherwise stated the results shown in this test report refer only to the sample(s) tested. This test report cannot be reproduced, except in full, without prior written permission of the Company. 除非另有說明，此報告結果僅對測試之樣品負責。本報告中述及本公司資訊皆受版權保護，不可擅自複製。
 This document is issued by the Company subject to its General Conditions of Service printed overleaf, available on request or accessible at www.sgs.com/terms_and_conditions.htm and, for electronic format documents, subject to Terms and Conditions for Electronic Documents at www.sgs.com/en/Terms-and-Conditions/Terms-e-Documents. Attention is drawn to the limitation of liability, indemnification and jurisdiction issues defined therein. Any holder of this document is advised that information contained herein reflects the Company's findings at the time of its intervention only and within the limits of Client's instructions, if any. The Company's sole responsibility is to its Client and this document does not exonerate parties to a transaction from exercising all their rights and obligations under the transaction documents. This document cannot be reproduced except in full, without prior written approval of the Company. Any unauthorized alteration, forgery or falsification of the content or appearance of this document is unlawful and offenders may be prosecuted to the fullest extent of the law.

SGS Taiwan Ltd. 33, Wu Chuan Road, Wu Ku District, New Taipei City, Taiwan 新北市五股區五權路 33 號
 台灣檢驗科技股份有限公司 t (886-2) 2299-3939 f (886-2) 2299-3955 www.sgs.tw
 Member of SGS Group



Report No.: OA-2012-90024

Page 3 of 40

Issued: Jun. 25, 2013

6 TEST CONDITIONS

Main Test Equipment:

| Name | Brand | Model | S/N | Traceability |
|---|-----------|--------------------|-------------------|--------------|
| Standard Light Source / Spectroradiometer | Labsphere | SCL-600 / CDS 2100 | D112 / 0811118355 | NIST |
| Source Meter | Kethley | 2400 | 1321218 | NMI |
| Handheld Digital Multimeter | Agilent | U1242A | MY48490144 | NMI |

Environmental Conditions:

Temperature: (25 ± 1) °C
Relative Humidity: < 65 % RH

LUT Conditions:

LED Light source: LED Package
Drive Current: DC 600 mA (Over spec., Define by Client)
Forward Voltage: DC 12 V (Typical)
Power Consumption: 7 W
CCT: 3000 K
Package Dimension: L 12 mm x W 15 mm x H 1.6 mm
Prior operation: 0 hour
Total Operation Duration: 6000 hours
Target CCT: 3000 K
Sample Size: 75 pcs (25 pcs for each temperature)
Failed Quantity: 0 pcs

Measurement Conditions:

Interval Time: 0, 1000, 2000, 3000, 4000, 5000, 6000 hours
Warm up Time: < 1 minute (Initial)
Relative measurement uncertainty: 2.8 % (95 % Confidence Level)

Unless otherwise stated the results shown in this test report refer only to the sample(s) tested. This test report cannot be reproduced, except in full, without prior written permission of the Company. 除非另有說明，此報告結果僅針對測試之樣品真實。本報告未經本公司書面許可，不可部分複製。
This document is issued by the Company subject to its General Conditions of Service printed overleaf, available on request or accessible at www.sgs.com/terms_and_conditions.htm and, for electronic format documents, subject to Terms and Conditions for Electronic Documents at www.sgs.com/en/Terms-and-Conditions/Terms-e-Document. Attention is drawn to the limitation of liability, indemnification and jurisdiction issues defined therein. Any holder of this document is advised that information contained hereon reflects the Company's findings at the time of its intervention only and within the limits of Client's instructions, if any. The Company's sole responsibility is to its Client and this document does not exonerate parties to a transaction from exercising all their rights and obligations under the transaction documents. This document cannot be reproduced except in full, without prior written approval of the Company. Any unauthorized alteration, forgery or falsification of the content or appearance of this document is unlawful and offenders may be prosecuted to the fullest extent of the law.

SGS Taiwan Ltd. 33, Wu Chuan Road, Wu Ku District, New Taipei City, Taiwan 新北市五股區五權路 33 號
台灣檢驗科技股份有限公司 t (886-2) 2299-3229 f (886-2) 2299-3255 www.sgs.tw
Member of SGS Group



Report No.: OA-2012-90024

Page 2 of 40

Issued: Jun. 25, 2013

1 SAMPLING DESCRIPTION

No sampling action and method employed

2 DATE OF RECEIPT OF SAMPLES

Sep. 24, 2012

3 DATE(S) OF PERFORMANCE OF THE TEST

Sep. 24, 2012 ~ Jun 17, 2013

4 IDENTITY OF SAMPLES

| Quantity | Model | Serial Number |
|----------|---------------------------|----------------------|
| 25 | JU1215-KM307N6-12507-090T | # A01 - # A25 (55 ℃) |
| 25 | JU1215-KM307N6-12507-090T | # B01 - # B25 (85 ℃) |
| 25 | JU1215-KM307N6-12507-090T | # C01 - # C25 (95 ℃) |

5 TEST ITEMS

5.1 Data Summary of Lumen and Color Maintenance

Test results were concluded by different Case Temperatures (Ts).

5.2 Lumen Maintenance and Color Maintenance Test

Testing specifications by different case temperatures according to IES LM-80-08 Approved Method: Measuring Lumen Maintenance of LED Light Sources and client's requirements were implemented per the following items.

5.2.1 Total Luminous Flux (Φ_v)

The test results of total luminous flux were implemented referring to Clause 2 PROPERTIES OF LEDS & Clause 6 MEASUREMENT OF LUMINOUS FLUX of CIE 127: 2007 2nd edition MEASUREMENT OF LEDS and IES LM-80-08 Approved Method: Measuring Lumen Maintenance of LED Light Sources, when the UUTs were powered with constant current of I_r.

5.2.2 Correlated Color Temperature (CCT), CIE Color Coordinate (CIEx, CIEy) & Chromaticity Shift ($\Delta u'v'$)

The test results of correlated color temperature were implemented referring to CIE 127:2007 2nd edition MEASUREMENT OF LEDS, CIE 15: 2004 COLORIMETRY.

The test results of color coordinate were implemented referring to CIE 127: 2007 2nd edition MEASUREMENT OF LEDS, CIE 15:2004 COLORIMETRY.

Unless otherwise stated the results shown in this test report refer only to the sample(s) tested. This test report cannot be reproduced, except in full, without prior written permission of the Company. 除非另有說明，此報告結果僅針對測試之產品與實。本報告中僅本公司會經許可，不可擅自複製。

This document is issued by the Company subject to its General Conditions of Service printed overleaf, available on request or accessible at www.sgs.com/terms_and_conditions.htm and, for electronic format documents, subject to Terms and Conditions for Electronic Documents at www.sgs.com/en/Terms-and-Conditions/Terms-e-Document. Attention is drawn to the limitation of liability, indemnification and jurisdiction issues defined therein. Any holder of this document is advised that information contained hereon reflects the Company's findings at the time of its intervention only and within the limits of Client's instructions, if any. The Company's sole responsibility is to its Client and this document does not exonerate parties to a transaction from exercising all their rights and obligations under the transaction documents. This document cannot be reproduced except in full, without prior written approval of the Company. Any unauthorized alteration, forgery or falsification of the content or appearance of this document is unlawful and offenders may be prosecuted to the fullest extent of the law.

SGS Taiwan Ltd. 33, Wu Chuan Road, Wu Ku District, New Taipei City, Taiwan (新北市五股區五權路 33 號)
 台灣檢驗科技股份有限公司 t:(886-2) 2299-3239 f:(886-2) 2298-3255 www.sgs.tw
 Member of SGS Group



Report No.: OA-2012-90024

Page 4 of 40

Issued: Jun. 25, 2013

7 TEST RESULTS

7.1 Data Summary of Lumen and Color Maintenance

| Temp. | Initial (0 hr) | | Luminous Maintenance (%) | | | | | |
|-----------|----------------|--------------------|--------------------------|----------|----------|----------|----------|----------|
| | TLF(lm) | V _F (V) | 1000 hrs | 2000 hrs | 3000 hrs | 4000 hrs | 5000 hrs | 6000 hrs |
| 55°C Avg. | 728.74 | 12.71 | 99.8 % | 99.1 % | 98.5 % | 97.4 % | 96.2 % | 94.4 % |
| 85°C Avg. | 728.84 | 12.70 | 99.6 % | 98.8 % | 98.2 % | 97.0 % | 95.5 % | 93.4 % |
| 95°C Avg. | 726.94 | 12.70 | 99.5 % | 98.5 % | 97.5 % | 96.3 % | 94.6 % | 92.1 % |

| Temp. | Initial (0 hr) | | | Chromaticity Shift ($\Delta u'v'$) | | | | | |
|-----------|----------------|--------|--------|--------------------------------------|----------|----------|----------|----------|----------|
| | CIEx | CIEy | OCT | 1000 hrs | 2000 hrs | 3000 hrs | 4000 hrs | 5000 hrs | 6000 hrs |
| 55°C Avg. | 0.4333 | 0.4048 | 3065.4 | 0.0003 | 0.0005 | 0.0005 | 0.0006 | 0.0007 | 0.0011 |
| 85°C Avg. | 0.4340 | 0.4052 | 3057.8 | 0.0003 | 0.0005 | 0.0005 | 0.0007 | 0.0007 | 0.0012 |
| 95°C Avg. | 0.4338 | 0.4053 | 3061.1 | 0.0003 | 0.0007 | 0.0007 | 0.0009 | 0.0008 | 0.0013 |

Lumen Maintenance Life Projection

Table 1: Report at each LM-80 Test Condition

| Description of LED Light Source Tested (manufacturer, model, catalog number) | | Test Condition 1 - 55°C Case Temp | | Test Condition 2 - 85°C Case Temp | | Test Condition 3 - 95°C Case Temp | |
|--|---------------|--|---------------|--|---------------|--|---------------|
| Sample size | 25 | Sample size | 25 | Sample size | 25 | Sample size | 25 |
| Number of failures | 0 | Number of failures | 0 | Number of failures | 0 | Number of failures | 0 |
| DUT drive current used in the test (mA) | 600 | DUT drive current used in the test (mA) | 600 | DUT drive current used in the test (mA) | 600 | DUT drive current used in the test (mA) | 600 |
| Test duration (hours) | 6,000 | Test duration (hours) | 6,000 | Test duration (hours) | 6,000 | Test duration (hours) | 6,000 |
| Test duration used for projection (hour to hour) | 1,000 - 6,000 | Test duration used for projection (hour to hour) | 1,000 - 6,000 | Test duration used for projection (hour to hour) | 1,000 - 6,000 | Test duration used for projection (hour to hour) | 1,000 - 6,000 |
| Tested case temperature (°C) | 55 | Tested case temperature (°C) | 85 | Tested case temperature (°C) | 95 | Tested case temperature (°C) | 95 |
| α | 1.081E-05 | α | 1.244E-05 | α | 1.486E-05 | α | 1.486E-05 |
| B | 1.013 | B | 1.014 | B | 1.015 | B | 1.015 |
| Calculated L70(6k) (hours) | (182,000) | Calculated L70(6k) (hours) | (158,000) | Calculated L70(6k) (hours) | (133,000) | Calculated L70(6k) (hours) | (133,000) |
| Reported L70(6k) (hours) | (182,000) | Reported L70(6k) (hours) | (158,000) | Reported L70(6k) (hours) | (133,000) | Reported L70(6k) (hours) | (133,000) |

Revision History

Current version: 10.29.2013

Issue No:

Version: 1

Created by: Leo Chou

| Page | Subjects (major change in previous version) | Date of change |
|------|---|----------------|
| | | |
| | | |
| | | |
| | | |
| | | |
| | | |