

# PLC-RSC- 24DC/2X21/FG - Relay Module



2910535

<https://www.phoenixcontact.com/us/products/2910535>

Please be informed that the data shown in this PDF document is generated from our online catalog. Please find the complete data in the user documentation. Our general terms of use for downloads are valid.



PLC-INTERFACE, consisting of a relay base and plug-in safety relay with force-guided contacts in accordance with DIN EN 61810-3, Screw connection, 2 changeover contacts, forcibly actuated, Freewheeling diode, Input voltage: 24 V DC

## Product description

The force-guided coupling relay module is approved for industrial control equipment in accordance with UL 508 (cULus listed). The requirements for type A in accordance with DIN EN 61810-3 are satisfied if the circuit is designed as 1 N/O contact / 1 N/C contact.

## Commercial data

Item number	2910535
Packing unit	1 pc
Minimum order quantity	1 pc
Sales key	C461
Product key	CK621C
Catalog page	Page 370 (C-5-2019)
GTIN	4055626486864
Weight per piece (including packing)	80.02 g
Weight per piece (excluding packing)	64 g
Customs tariff number	85364190
Country of origin	DE

## Technical data

### Product properties

Product type	Relay Module
Product family	PLC-INTERFACE
Application	Forcibly guided contacts
Operating mode	100% operating factor
Mechanical service life	approx. $10^7$ cycles
B <sub>10d</sub>	600000 Cycles (AC1; 250 V / 6 A; 1 NO)
	900000 Cycles (AC1; 250 V / 3 A; 1 NO)
	1800000 Cycles (AC1; 250 V / 1,5 A; 1 NO)
	180000 Cycles (AC15; 250 V / 3 A; 1 NO)
	560000 Cycles (AC15; 250 V / 2 A; 1 NO)
	4600000 Cycles (AC15; 250 V / 0,75 A; 1 NO)
	360000 Cycles (DC13; 24 V / 3 A; 1 NO)
	740000 Cycles (DC13; 24 V / 1,5 A; 1 NO)
	4200000 Cycles (DC13; 24 V / 0,75 A; 1 NO)

### Insulation characteristics

Insulation	Safe isolation, reinforced insulation
------------	---------------------------------------

### Insulation characteristics: Standards/regulations

Insulation	Safe isolation, reinforced insulation
Overvoltage category	III
Pollution degree	2

### Electrical properties

Maximum power dissipation for nominal condition	0.72 W
Test voltage (Winding/contact)	4 kV <sub>rms</sub> (50 Hz, 1 min., winding/contact)
Test voltage (Changeover contact/changeover contact)	2.5 kV <sub>rms</sub> (50 Hz, 1 min., changeover contact/changeover contact)

### Standards/regulations

Rated insulation voltage	250 V AC
Rated surge voltage	6 kV

### Input data

#### Coil side

Nominal input voltage U <sub>N</sub>	24 V DC
Input voltage range	20.2 V DC ... 32.4 V DC (20 °C)
Input voltage range in reference to U <sub>N</sub>	see diagram
Drive and function	monostable
Drive (polarity)	polarized
Typical input current at U <sub>N</sub>	30 mA
Typical response time	10 ms

# PLC-RSC- 24DC/2X21/FG - Relay Module



2910535

<https://www.phoenixcontact.com/us/products/2910535>

Typical release time	10 ms
Coil voltage	24 V DC
Protective circuit	Freewheeling diode
Operating voltage display	Yellow LED

## Output data

### Switching

Contact switching type	2 changeover contacts, forcibly actuated
Type of switch contact	Single contact
Contact material	AgNi
Maximum switching voltage	250 V AC/DC
Minimum switching voltage	5 V (10 mA)
Limiting continuous current	6 A
Maximum inrush current	6 A
Min. switching current	10 mA (5 V)
Interrupting rating (ohmic load) max.	144 W (24 V DC) 288 W (48 V DC) 88 W (110 V DC) 110 W (220 V DC) 1500 VA (250 V AC)
Switching capacity min.	150 mW
Switching capacity	3 A (24 V, DC13) 3 A (230 V, AC15)
Force-guided contacts in accordance with EN 61810-3	Type B

## Connection data

Connection method	Screw connection
Stripping length	8 mm
Screw thread	M3
Conductor cross section rigid	0.14 mm <sup>2</sup> ... 2.5 mm <sup>2</sup>
Conductor cross section flexible	0.14 mm <sup>2</sup> ... 2.5 mm <sup>2</sup> 0.2 mm <sup>2</sup> ... 2.5 mm <sup>2</sup> (Single ferrule) 2x 0.5 mm <sup>2</sup> ... 1.5 mm <sup>2</sup> (TWIN ferrule)
Conductor cross section AWG	26 ... 14
Tightening torque	0.6 Nm ... 0.8 Nm

## Dimensions

Width	14 mm
Height	80 mm
Depth	104 mm

## Environmental and real-life conditions

### Ambient conditions

# PLC-RSC- 24DC/2X21/FG - Relay Module



2910535

<https://www.phoenixcontact.com/us/products/2910535>

Degree of protection (Relay)	RT II (Relay)
Degree of protection (Relay base)	IP20 (Relay base)
Degree of protection (Installation location)	≥ IP54 (Installation location)
Ambient temperature (operation)	-20 °C ... 60 °C
Ambient temperature (storage/transport)	-20 °C ... 85 °C
Altitude	≤ 2000 m

## Approvals

### UL, USA

Identification	UL 508
	UL 508 Recognized

### UL, USA/Canada

Identification	UL 508
	UL 508 Recognized

### Corrosive gas test

Identification	ISA-S71.04. G3 Harsh Group
	EN 60068-2-60

## Standards and regulations

### Standards/regulations

Standards/regulations	IEC 60947-5-1
	DIN EN 61810-3

## Mounting

Mounting type	DIN rail mounting
Assembly instructions	in rows with zero spacing
Mounting position	any

## Drawings

Diagram

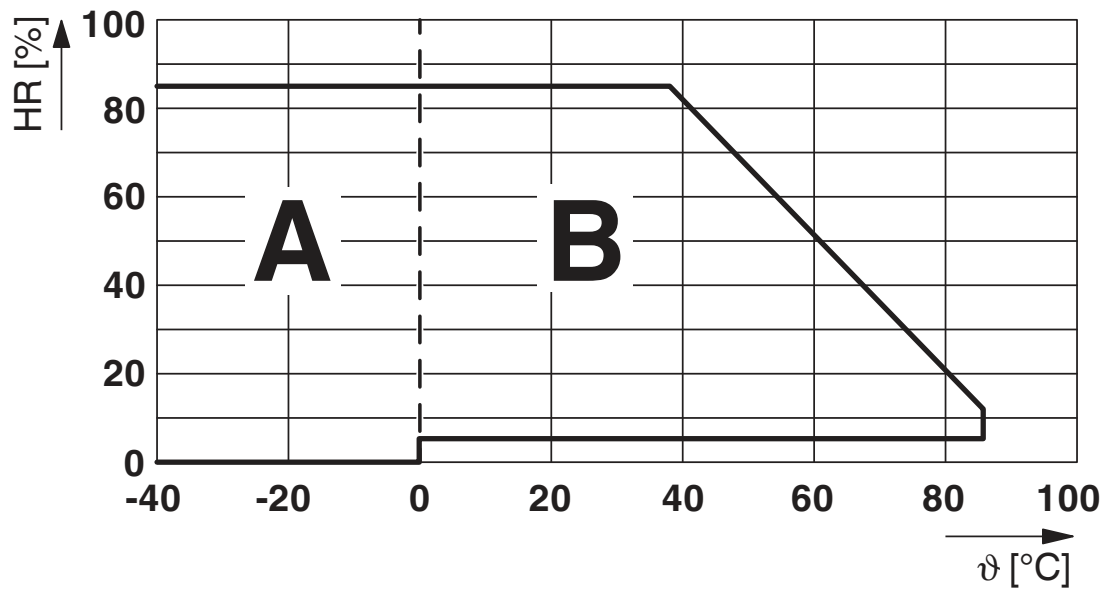

Permissible humidity for operation and storage.

The maximum permissible ambient temperature as specified in the data sheet must be observed.

Area A: Ice buildup at ambient temperatures  $\leq 0^\circ\text{C}$  must be prevented

Area B: Condensation at ambient temperatures  $> 0^\circ\text{C}$  must be prevented

On 30 full days that are naturally distributed across an entire year, a humidity level of 95% is permissible at an ambient temperature  $\leq 25^\circ\text{C}$ .

Diagram

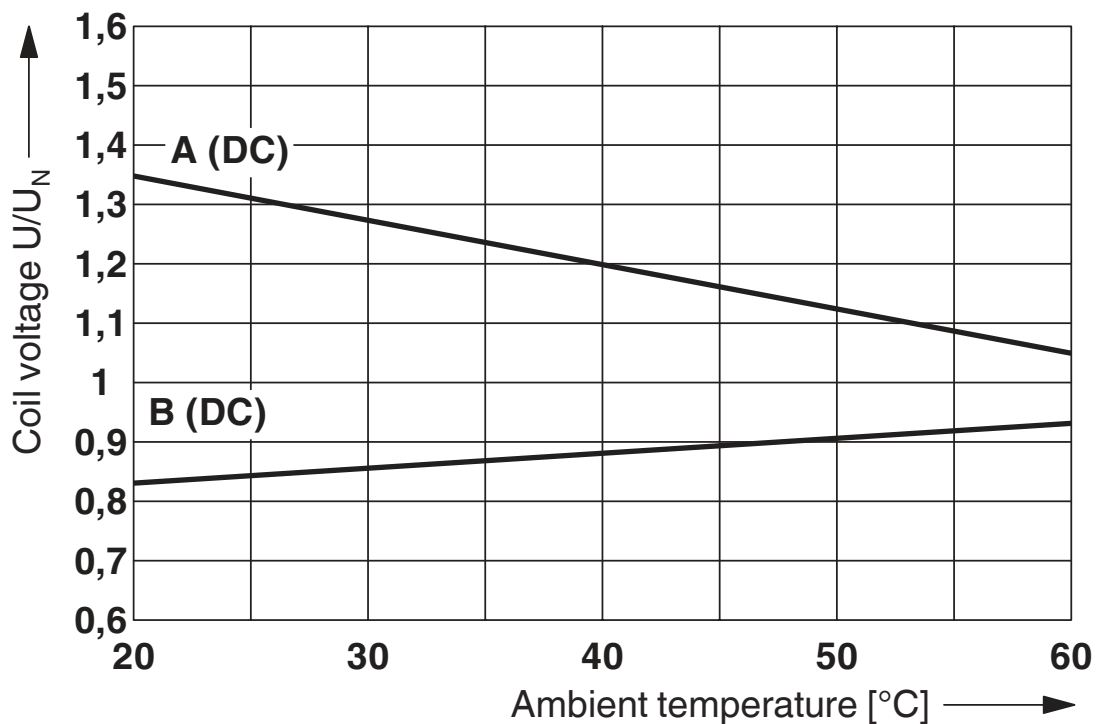

Curve A: maximum continuous voltage at limiting continuous current

Curve B: minimum pick-up voltage for pre-excitation with  $U_N$  and limiting continuous current

Circuit diagram

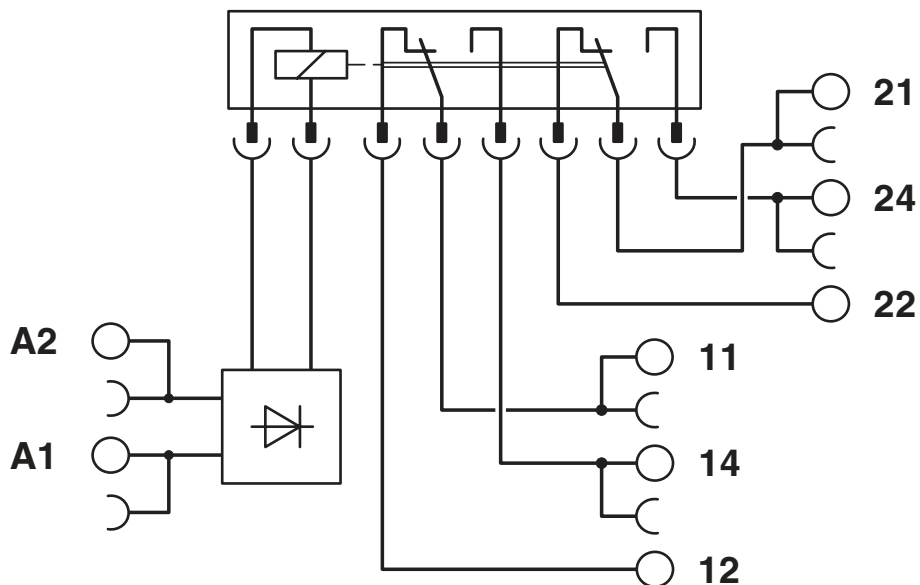

# PLC-RSC- 24DC/2X21/FG - Relay Module



2910535

<https://www.phoenixcontact.com/us/products/2910535>

## Approvals

To download certificates, visit the product detail page: <https://www.phoenixcontact.com/us/products/2910535>



**EAC**

Approval ID: TR\_TS\_D\_00573\_c



**DNV GL**

Approval ID: TAE0000196



**EAC**

Approval ID: RU\*C-DE.\*08.B.00010



**UL Listed**

Approval ID: FILE E 172140



**cUL Listed**

Approval ID: FILE E 172140

**cULus Listed**

# PLC-RSC- 24DC/2X21/FG - Relay Module



2910535

<https://www.phoenixcontact.com/us/products/2910535>

## Classifications

### ECLASS

ECLASS-11.0	27371601
ECLASS-12.0	27371601
ECLASS-13.0	27371601

### ETIM

ETIM 8.0	EC001437
----------	----------

### UNSPSC

UNSPSC 21.0	39122300
-------------	----------



# PLC-RSC- 24DC/2X21/FG - Relay Module



2910535

<https://www.phoenixcontact.com/us/products/2910535>

## Environmental product compliance

REACH SVHC	Lead 7439-92-1
	Hexahydromethylphthalic anhydride
China RoHS	Environmentally Friendly Use Period = 50 years
	For information on hazardous substances, refer to the manufacturer's declaration available under "Downloads"

# PLC-RSC- 24DC/2X21/FG - Relay Module

2910535

<https://www.phoenixcontact.com/us/products/2910535>

## Accessories

 Note: Applying some accessories below might limit this product.

### FBST 500-PLC RD - Continuous plug-in bridge

2966786

<https://www.phoenixcontact.com/us/products/2966786>



Continuous plug-in bridge, length: 500 mm, color: red

 Max. current carrying capacity: 32 A

---

### FBST 500-PLC BU - Continuous plug-in bridge

2966692

<https://www.phoenixcontact.com/us/products/2966692>



Continuous plug-in bridge, length: 500 mm, color: blue

 Max. current carrying capacity: 32 A

# PLC-RSC- 24DC/2X21/FG - Relay Module

2910535

<https://www.phoenixcontact.com/us/products/2910535>



## FBST 500-PLC GY - Continuous plug-in bridge

2966838

<https://www.phoenixcontact.com/us/products/2966838>



Continuous plug-in bridge, length: 500 mm, color: gray

 Max. current carrying capacity: 32 A

---

## FBST 6-PLC RD - Single plug-in bridge

2966236

<https://www.phoenixcontact.com/us/products/2966236>



Single plug-in bridge, number of positions: 2, length: 6 mm, color: red

 Max. current carrying capacity: 6 A

# PLC-RSC- 24DC/2X21/FG - Relay Module

2910535

<https://www.phoenixcontact.com/us/products/2910535>

## FBST 6-PLC BU - Single plug-in bridge

2966812

<https://www.phoenixcontact.com/us/products/2966812>

Single plug-in bridge, number of positions: 2, length: 6 mm, color: blue



 Max. current carrying capacity: 6 A

---

## FBST 6-PLC GY - Single plug-in bridge

2966825

<https://www.phoenixcontact.com/us/products/2966825>

Single plug-in bridge, number of positions: 2, length: 6 mm, color: gray



 Max. current carrying capacity: 6 A

# PLC-RSC- 24DC/2X21/FG - Relay Module

2910535

<https://www.phoenixcontact.com/us/products/2910535>

## FBST 8-PLC GY - Single plug-in bridge

2967688

<https://www.phoenixcontact.com/us/products/2967688>

Single plug-in bridge, number of positions: 2, length: 8 mm, color: gray



 Max. current carrying capacity: 6 A

---

## FBST 14-PLC BK - Single plug-in bridge

2967691

<https://www.phoenixcontact.com/us/products/2967691>

Single plug-in bridge, number of positions: 2, length: 14 mm, color: black



 Max. current carrying capacity: 10 A

# PLC-RSC- 24DC/2X21/FG - Relay Module



2910535

<https://www.phoenixcontact.com/us/products/2910535>

## ZB 10:UNBEDRUCKT - Zack marker strip

1053001

<https://www.phoenixcontact.com/us/products/1053001>



Zack marker strip, Strip, white, unlabeled, can be labeled with: PLOTMARK, CMS-P1-PLOTTER, mounting type: snapped, for terminal block width: 10.2 mm, lettering field size: 10.5 x 10.15 mm, Number of individual labels: 10

---

## ZB 10 CUS - Zack marker strip

0824941

<https://www.phoenixcontact.com/us/products/0824941>



Zack marker strip, can be ordered: Strip, white, labeled according to customer specifications, mounting type: snap into tall marker groove, for terminal block width: 10.2 mm, lettering field size: 10,15 x 10,5 mm, Number of individual labels: 10

# PLC-RSC- 24DC/2X21/FG - Relay Module



2910535

<https://www.phoenixcontact.com/us/products/2910535>

## ZB10,LGS:FORTL.ZAHLEN - Zack marker strip

1053014

<https://www.phoenixcontact.com/us/products/1053014>



Zack marker strip, Strip, white, labeled, can be labeled with: CMS-P1-PLOTTER, printed horizontally: consecutive numbers 1 ... 10, 11 ... 20, etc. up to 91 ... 100, mounting type: snapped, for terminal block width: 10.2 mm, lettering field size: 10,15 x 10,5 mm, Number of individual labels: 10

---

## ZB10,QR:FORTL.ZAHLEN - Zack marker strip

1053027

<https://www.phoenixcontact.com/us/products/1053027>



Zack marker strip, Strip, white, labeled, can be labeled with: CMS-P1-PLOTTER, Printed vertically: consecutive numbers 1 ... 10, 11 ... 20, etc. up to 91 ... 100, mounting type: snapped, for terminal block width: 10.2 mm, lettering field size: 10,15 x 10,5 mm, Number of individual labels: 10

# PLC-RSC- 24DC/2X21/FG - Relay Module



2910535

<https://www.phoenixcontact.com/us/products/2910535>

## ZB10,LGS:L1-N,PE - Marker for terminal blocks

1053412

<https://www.phoenixcontact.com/us/products/1053412>



Marker for terminal blocks, Strip, white, labeled, can be labeled with: CMS-P1-PLOTTER, horizontal: L1, L2, L3, N, PE, L1, L2, L3, N, PE, mounting type: snapped, for terminal block width: 10.2 mm, lettering field size: 10,15 x 10,5 mm, Number of individual labels: 10

---

## ZB10,LGS:U-N - Marker for terminal blocks

1053438

<https://www.phoenixcontact.com/us/products/1053438>



Marker for terminal blocks, Strip, white, labeled, can be labeled with: CMS-P1-PLOTTER, horizontal: U, V, W, N, GND, U, V, W, N, GND, mounting type: snapped, for terminal block width: 10.2 mm, lettering field size: 10,15 x 10,5 mm, Number of individual labels: 10



# PLC-RSC- 24DC/2X21/FG - Relay Module



2910535

<https://www.phoenixcontact.com/us/products/2910535>

## UC-TM 10 - Marker for terminal blocks

0818069

<https://www.phoenixcontact.com/us/products/0818069>



Marker for terminal blocks, Sheet, white, unlabeled, can be labeled with: BLUEMARK ID COLOR, BLUEMARK ID, BLUEMARK CLED, PLOTMARK, CMS-P1-PLOTTER, mounting type: snapped, for terminal block width: 10.2 mm, lettering field size: 9.6 x 10.5 mm, Number of individual labels: 48

---

## UC-TM 10 CUS - Marker for terminal blocks

0824605

<https://www.phoenixcontact.com/us/products/0824605>



Marker for terminal blocks, can be ordered: by sheet, white, labeled according to customer specifications, mounting type: snap into tall marker groove, for terminal block width: 10.2 mm, lettering field size: 9.6 x 10.5 mm, Number of individual labels: 48

# PLC-RSC- 24DC/2X21/FG - Relay Module



2910535

<https://www.phoenixcontact.com/us/products/2910535>

## UCT-TM 10 - Marker for terminal blocks

0829142

<https://www.phoenixcontact.com/us/products/0829142>



Marker for terminal blocks, Sheet, white, unlabeled, can be labeled with: TOPMARK NEO, TOPMARK LASER, BLUEMARK ID COLOR, BLUEMARK ID, BLUEMARK CLED, THERMOMARK PRIME, THERMOMARK CARD 2.0, THERMOMARK CARD, mounting type: snapped, for terminal block width: 10.2 mm, lettering field size: 8.9 x 9.6 mm, Number of individual labels: 36

---

## UCT-TM 10 CUS - Marker for terminal blocks

0829623

<https://www.phoenixcontact.com/us/products/0829623>



Marker for terminal blocks, can be ordered: by sheet, white, labeled according to customer specifications, mounting type: snap into tall marker groove, for terminal block width: 10.2 mm, lettering field size: 8.9 x 9.6 mm, Number of individual labels: 36

# PLC-RSC- 24DC/2X21/FG - Relay Module



2910535

<https://www.phoenixcontact.com/us/products/2910535>

## ZB 12:UNPRINTED - Zack marker strip

0812120

<https://www.phoenixcontact.com/us/products/0812120>



Zack marker strip, Strip, white, unlabeled, can be labeled with: PLOTMARK, CMS-P1-PLOTTER, mounting type: snapped, for terminal block width: 12.2 mm, lettering field size: 12 x 10.5 mm, Number of individual labels: 5

---

## ZB 12 CUS - Zack marker strip

0824942

<https://www.phoenixcontact.com/us/products/0824942>



Zack marker strip, can be ordered: Strip, white, labeled according to customer specifications, mounting type: snap into tall marker groove, for terminal block width: 12.2 mm, lettering field size: 10.5 x 12.15 mm, Number of individual labels: 5

# PLC-RSC- 24DC/2X21/FG - Relay Module



2910535

<https://www.phoenixcontact.com/us/products/2910535>

## ZB 12,LGS:L1-N,PE - Zack marker strip

0812146

<https://www.phoenixcontact.com/us/products/0812146>



Zack marker strip, Strip, white, labeled, printed horizontally: L1, L2, L3, N, PE, mounting type: snapped, for terminal block width: 12.2 mm, lettering field size: 10.5 x 12.15 mm, Number of individual labels: 5

---

## UC-TM 12 - Marker for terminal blocks

0819194

<https://www.phoenixcontact.com/us/products/0819194>



Marker for terminal blocks, Sheet, white, unlabeled, can be labeled with: BLUEMARK ID COLOR, BLUEMARK ID, BLUEMARK CLED, PLOTMARK, CMS-P1-PLOTTER, mounting type: snapped, for terminal block width: 12 mm, lettering field size: 11.45 x 10.5 mm, Number of individual labels: 40

# PLC-RSC- 24DC/2X21/FG - Relay Module



2910535

<https://www.phoenixcontact.com/us/products/2910535>

## UC-TM 12 CUS - Marker for terminal blocks

0824613

<https://www.phoenixcontact.com/us/products/0824613>



Marker for terminal blocks, can be ordered: by sheet, white, labeled according to customer specifications, mounting type: snap into tall marker groove, for terminal block width: 12 mm, lettering field size: 11.45 x 10.5 mm, Number of individual labels: 40

---

## UCT-TM 12 - Marker for terminal blocks

0829144

<https://www.phoenixcontact.com/us/products/0829144>



Marker for terminal blocks, Sheet, white, unlabeled, can be labeled with: TOPMARK NEO, TOPMARK LASER, BLUEMARK ID COLOR, BLUEMARK ID, BLUEMARK CLED, THERMOMARK PRIME, THERMOMARK CARD 2.0, THERMOMARK CARD, mounting type: snapped, for terminal block width: 12 mm, lettering field size: 10.8 x 9.6 mm, Number of individual labels: 30

# PLC-RSC- 24DC/2X21/FG - Relay Module



2910535

<https://www.phoenixcontact.com/us/products/2910535>

## UCT-TM 12 CUS - Marker for terminal blocks

0829630

<https://www.phoenixcontact.com/us/products/0829630>



Marker for terminal blocks, can be ordered: by sheet, white, labeled according to customer specifications, mounting type: snap into tall marker groove, for terminal block width: 12 mm, lettering field size: 10.8 x 9.6 mm, Number of individual labels: 30

---

## NS 35/ 7,5 PERF 2000MM - DIN rail perforated

0801733

<https://www.phoenixcontact.com/us/products/0801733>



DIN rail perforated, acc. to EN 60715, material: Steel, galvanized, passivated with a thick layer, Standard profile, color: silver, Pack of 25 (50 m)

# PLC-RSC- 24DC/2X21/FG - Relay Module

2910535

<https://www.phoenixcontact.com/us/products/2910535>

## NS 35/ 7,5 UNPERF 2000MM - DIN rail, unperforated

0801681

<https://www.phoenixcontact.com/us/products/0801681>



DIN rail, unperforated, acc. to EN 60715, material: Steel, galvanized, passivated with a thick layer, Standard profile, color: silver, Pack of 25 (50 m)

---

## NS 35/ 7,5 WH PERF 2000MM - DIN rail perforated

1204119

<https://www.phoenixcontact.com/us/products/1204119>



DIN rail perforated, acc. to EN 60715, material: Steel, Galvanized, white passivated, Standard profile, color: silver, Pack of 25 (50 m)

# PLC-RSC- 24DC/2X21/FG - Relay Module

2910535

<https://www.phoenixcontact.com/us/products/2910535>



## NS 35/ 7,5 WH UNPERF 2000MM-VPE 10 - DIN rail, unperforated

1204122

<https://www.phoenixcontact.com/us/products/1204122>



DIN rail, unperforated, acc. to EN 60715, material: Steel, Galvanized, white passivated, Standard profile, color: silver, Pack of 10 (20 m)

---

## NS 35/ 7,5 AL UNPERF 2000MM - DIN rail, unperforated

0801704

<https://www.phoenixcontact.com/us/products/0801704>



DIN rail, unperforated, acc. to EN 60715, material: Aluminum, uncoated, Standard profile, color: silver, Pack of 25 (50 m)



# PLC-RSC- 24DC/2X21/FG - Relay Module

2910535

<https://www.phoenixcontact.com/us/products/2910535>

## NS 35/ 7,5 ZN PERF 2000MM - DIN rail perforated

1206421

<https://www.phoenixcontact.com/us/products/1206421>



DIN rail perforated, acc. to EN 60715, material: Steel, galvanized, Standard profile, color: silver, Pack of 25 (50 m)

---

## NS 35/ 7,5 ZN UNPERF 2000MM - DIN rail, unperforated

1206434

<https://www.phoenixcontact.com/us/products/1206434>



DIN rail, unperforated, acc. to EN 60715, material: Steel, galvanized, Standard profile, color: silver, Pack of 25 (50 m)

# PLC-RSC- 24DC/2X21/FG - Relay Module



2910535

<https://www.phoenixcontact.com/us/products/2910535>

## NS 35/ 7,5 CU UNPERF 2000MM-VPE 10 - DIN rail, unperforated

0801762

<https://www.phoenixcontact.com/us/products/0801762>



DIN rail, unperforated, acc. to EN 60715, material: Copper, uncoated, Standard profile, color: copper-colored, Pack of 10 (20 m)

---

## NS 35/ 7,5 CAP - End cap

1206560

<https://www.phoenixcontact.com/us/products/1206560>

DIN rail end piece, for DIN rail NS 35/7.5



# PLC-RSC- 24DC/2X21/FG - Relay Module



2910535

<https://www.phoenixcontact.com/us/products/2910535>

## NS 35/15 PERF 2000MM - DIN rail perforated

1201730

<https://www.phoenixcontact.com/us/products/1201730>



DIN rail perforated, similar to EN 60715, material: Steel, galvanized, passivated with a thick layer, Standard profile, color: silver, Pack of 25 (50 m)

---

## NS 35/15 UNPERF 2000MM - DIN rail, unperforated

1201714

<https://www.phoenixcontact.com/us/products/1201714>



DIN rail, unperforated, similar to EN 60715, material: Steel, galvanized, passivated with a thick layer, Standard profile, color: silver, Pack of 25 (50 m)

# PLC-RSC- 24DC/2X21/FG - Relay Module



2910535

<https://www.phoenixcontact.com/us/products/2910535>

## NS 35/15 WH PERF 2000MM - DIN rail perforated

0806602

<https://www.phoenixcontact.com/us/products/0806602>



DIN rail perforated, similar to EN 60715, material: Steel, Galvanized, white passivated, Standard profile, color: white, Pack of 25 (50 m)

---

## NS 35/15 WH UNPERF 2000MM-VPE 10 - DIN rail, unperforated

1204135

<https://www.phoenixcontact.com/us/products/1204135>



DIN rail, unperforated, similar to EN 60715, material: Steel, Galvanized, white passivated, Standard profile, color: silver, Pack of 10 (20 m)

# PLC-RSC- 24DC/2X21/FG - Relay Module



2910535

<https://www.phoenixcontact.com/us/products/2910535>

## NS 35/15 AL UNPERF 2000MM - DIN rail, unperforated

1201756

<https://www.phoenixcontact.com/us/products/1201756>



DIN rail, unperforated, similar to EN 60715, material: Aluminum, uncoated, Standard profile, color: silver

---

## NS 35/15 ZN PERF 2000MM - DIN rail perforated

1206599

<https://www.phoenixcontact.com/us/products/1206599>



DIN rail perforated, similar to EN 60715, material: Steel, galvanized, Standard profile, color: silver, Pack of 25 (50 m)

# PLC-RSC- 24DC/2X21/FG - Relay Module

2910535

<https://www.phoenixcontact.com/us/products/2910535>

## NS 35/15 ZN UNPERF 2000MM - DIN rail, unperforated

1206586

<https://www.phoenixcontact.com/us/products/1206586>



DIN rail, unperforated, similar to EN 60715, material: Steel, galvanized, Standard profile, color: silver, Pack of 25 (50 m)

---

## NS 35/15 CU UNPERF 2000MM-VPE 10 - DIN rail, unperforated

1201895

<https://www.phoenixcontact.com/us/products/1201895>



DIN rail, unperforated, similar to EN 60715, material: Copper, uncoated, Standard profile, color: copper-colored, Pack of 10 (20 m)

# PLC-RSC- 24DC/2X21/FG - Relay Module



2910535

<https://www.phoenixcontact.com/us/products/2910535>

## NS 35/15 CAP - End cap

1206573

<https://www.phoenixcontact.com/us/products/1206573>

DIN rail end piece, for DIN rail NS 35/15



---

## NS 35/15-2,3 UNPERF 2000MM-VPE 10 - DIN rail, unperforated

1201798

<https://www.phoenixcontact.com/us/products/1201798>

DIN rail, unperforated, acc. to EN 60715, material: Steel, galvanized, passivated with a thick layer, Standard profile 2.3 mm, color: silver, Pack of 10 (20 m)



# PLC-RSC- 24DC/2X21/FG - Relay Module

2910535

<https://www.phoenixcontact.com/us/products/2910535>

## PLC-ATP BK - Separating plate

2966841

<https://www.phoenixcontact.com/us/products/2966841>



Separating plate, 2 mm thick, required at the start and end of a PLC terminal strip. Furthermore, it is used for: visual separation of groups, safe isolation of different voltages of neighboring PLC relays in acc. with DIN VDE 0106-101, isolation

---

## PLC-ESK GY - Power terminal block

2966508

<https://www.phoenixcontact.com/us/products/2966508>



Power terminal block, for the input of up to four potentials, for mounting on NS 35/7.5



# PLC-RSC- 24DC/2X21/FG - Relay Module



2910535

<https://www.phoenixcontact.com/us/products/2910535>

## SZF 1-0,6X3,5 - Screwdriver

1204517

<https://www.phoenixcontact.com/us/products/1204517>



Actuation tool, for ST terminal blocks, also suitable for use as a bladed screwdriver, size: 0.6 x 3.5 x 100 mm, 2-component grip, with non-slip grip

---

## REL-SR- 24DC/2X21/FG - Safety relays

2908777

<https://www.phoenixcontact.com/us/products/2908777>



Safety relay with force-guided contacts in accordance with DIN EN 61810-3, contact switching type: 2 changeover contacts. The requirements for type A in accordance with DIN EN 61810-3 are satisfied if the circuit is designed as 1 N/O contact / 1 N/C contact.

---

Phoenix Contact 2023 © - all rights reserved  
<https://www.phoenixcontact.com>

Phoenix Contact USA  
586 Fulling Mill Road  
Middletown, PA 17057, United States  
(+717) 944-1300  
[info@phoenixcon.com](mailto:info@phoenixcon.com)