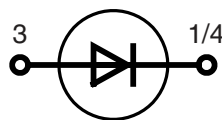
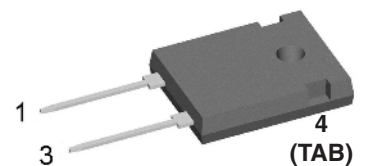

# Fast Recovery Epitaxial Diode (FRED)

 $I_{FAV} = 126 \text{ A}$   
 $V_{RRM} = 600 \text{ V}$   
 $t_{rr} = 35 \text{ ns}$ 
**Part number**

DSEI 120-06A

**TO-247AD**

**Features / Advantages:**

- Planar passivated chips
- Low leakage current
- Very short recovery time
- Improved thermal behaviour
- Extremely low switching losses
- Low  $I_{RM}$ -values
- Soft recovery behaviour
- High reliability circuit operation
- Low voltage peaks for reduced protection circuits
- Low noise switching
- Low losses
- Operating at lower temperature or space saving by reduced cooling

**Applications:**

- Antiparallel diode for high frequency switching devices
- Antisaturation diode
- Snubber diode
- Free wheeling diode in converters and motor control circuits
- Rectifiers in switch mode power supplies (SMPS)
- Inductive heating and melting
- Uninterruptible power supplies (UPS)
- Ultrasonic cleaners and welders

**Package:** TO-247AD

- Industry standard outline
- RoHS compliant
- Epoxy meets UL 94V-0

**Disclaimer Notice**

Information furnished is believed to be accurate and reliable. However, users should independently evaluate the suitability of and test each product selected for their own applications. Littelfuse products are not designed for, and may not be used in, all applications. Read complete Disclaimer Notice at [www.littelfuse.com/disclaimer-electronics](http://www.littelfuse.com/disclaimer-electronics).

Symbol	Conditions	Maximum Ratings	
$I_{FRMS}$	$T_{VJ} = T_{VJM}$	100	A
$I_{FAVM}$ ①	$T_C = 70^\circ\text{C}$ ; rectangular, $d = 0.5$	126	A
$I_{FAV}$ ②	$T_C = 110^\circ\text{C}$ ; rectangular, $d = 0.5$	77	A
$I_{FRM}$	$t_p < 10$ s; rep. rating, pulse width limited by $T_{VJM}$	1200	A
$I_{FSM}$	$T_{VJ} = 45^\circ\text{C}$ ; $t = 10$ ms (50 Hz), sine	600	A
	$t = 8.3$ ms (60 Hz), sine	660	A
	$T_{VJ} = 150^\circ\text{C}$ ; $t = 10$ ms (50 Hz), sine	540	A
	$t = 8.3$ ms (60 Hz), sine	600	A
$I^2t$	$T_{VJ} = 45^\circ\text{C}$ ; $t = 10$ ms (50 Hz), sine	1800	A <sup>2</sup> s
	$t = 8.3$ ms (60 Hz), sine	1800	A <sup>2</sup> s
	$T_{VJ} = 150^\circ\text{C}$ ; $t = 10$ ms (50 Hz), sine	1450	A <sup>2</sup> s
	$t = 8.3$ ms (60 Hz), sine	1500	A <sup>2</sup> s
$P_{tot}$	$T_C = 25^\circ\text{C}$	357	W

Symbol	Conditions	Characteristic Values		
		typ.	max.	
$I_R$	$V_R = V_{RRM}$ $T_{VJ} = 25^\circ\text{C}$		3	mA
	$V_R = 0.8 \cdot V_{RRM}$ $T_{VJ} = 25^\circ\text{C}$		0.75	mA
	$V_R = 0.8 \cdot V_{RRM}$ $T_{VJ} = 125^\circ\text{C}$		20	mA
$V_F$	$I_F = 70$ A $T_{VJ} = 150^\circ\text{C}$		1.12	V
	$T_{VJ} = 25^\circ\text{C}$		1.30	V
$V_{T0}$	For power-loss calculations only		0.85	V
$r_T$	$T_{VJ} = T_{VJM}$		3.50	m $\Omega$
$R_{thJC}$		0.25	0.35	K/W
$R_{thCH}$			K/W	
$R_{thJA}$			35	K/W
$t_{rr}$	$I_F = 1$ A; $-di/dt = 200$ A/ $\mu\text{s}$ ; $V_R = 30$ V; $T_{VJ} = 25^\circ\text{C}$	35	50	ns
$I_{RM}$	$V_R = 350$ V; $I_F = 80$ A; $-di_F/dt = 200$ A/ $\mu\text{s}$ $L \leq 0.05$ $\mu\text{H}$ ; $T_{VJ} = 100^\circ\text{C}$	17	21	A

① Chip capability; ② limited to 70 A by leads

Data according to IEC 60747

**Outline Drawing TO-247AD**

Dimensions in mm (1 mm = 0.0394")

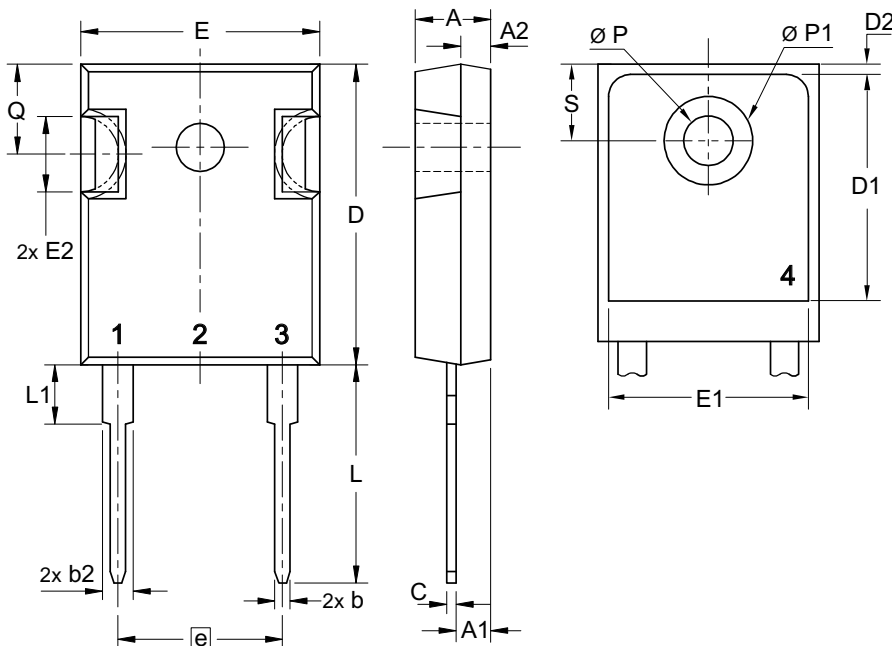

Sym.	Inches		Millimeter	
	min.	max.	min.	max.
A	0.185	0.209	4.70	5.30
A1	0.087	0.102	2.21	2.59
A2	0.059	0.098	1.50	2.49
D	0.819	0.845	20.79	21.45
E	0.610	0.640	15.48	16.24
E2	0.170	0.216	4.31	5.48
e	0.430 BSC		10.92 BSC	
L	0.780	0.800	19.80	20.30
L1	-	0.177	-	4.49
$\emptyset P$	0.140	0.144	3.55	3.65
Q	0.212	0.244	5.38	6.19
S	0.242 BSC		6.14 BSC	
b	0.039	0.055	0.99	1.40
b2	0.065	0.094	1.65	2.39
b4	0.102	0.135	2.59	3.43
c	0.015	0.035	0.38	0.89
D1	0.515	-	13.07	-
D2	0.020	0.053	0.51	1.35
E1	0.530	-	13.45	-
$\emptyset P1$	-	0.29	-	7.39

IXYS reserves the right to change limits, test conditions and dimensions.

20220615b

Package TO-247AD			Ratings			
Symbol	Definitions	Conditions	min.	typ.	max.	
$T_{vj}$	virtual junction temperature		-40		150	°C
$T_{stg}$	storage temperature		-40		150	°C
<b>Weight</b>				6		g
$M_D$	mounting torque		0.8		1.2	Nm

### Product Marking

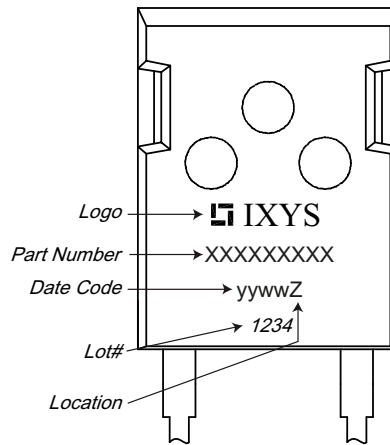

Ordering	Part Number	Marking on Product	Delivering Mode	Base Qty	Ordering Code
Standard	DSEI120-06A	DSEI120-06A	Tube	30	467871

**Curves**

 Fig. 1 Forward current  $I_F$  vs.  $V_F$ 

 Fig. 2 Reverse recovery charge  $Q_r$  versus  $-di_F/dt$ 

 Fig. 3 Peak reverse current  $I_{RM}$  versus  $-di_F/dt$ 

 Fig. 4 Dynamic parameters  $Q_r$ ,  $I_{RM}$  versus  $T_{VJ}$ 

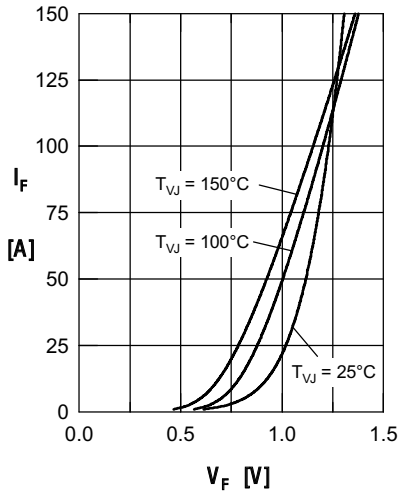
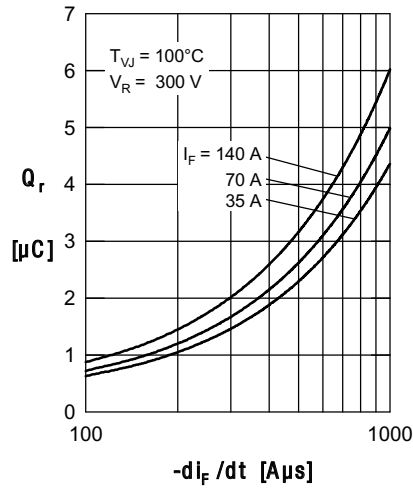
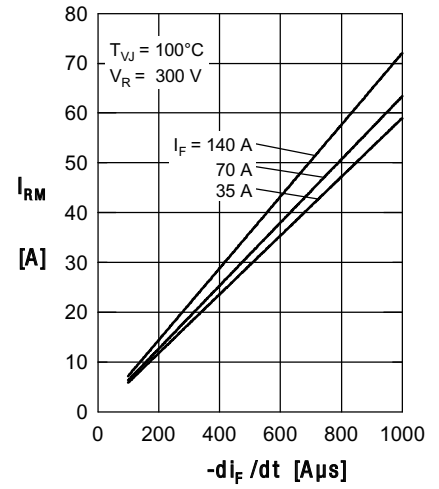
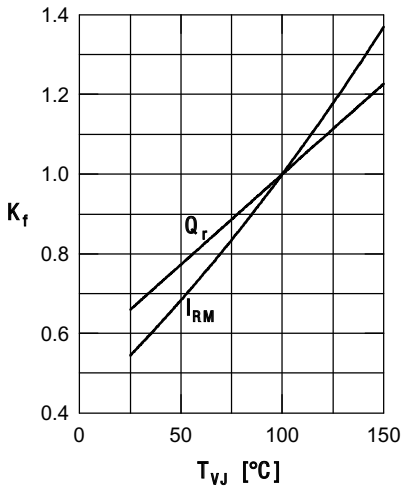
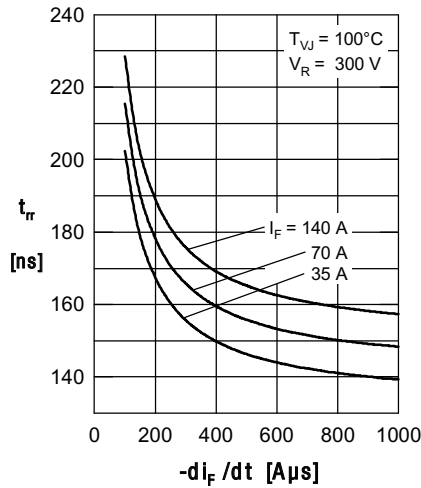
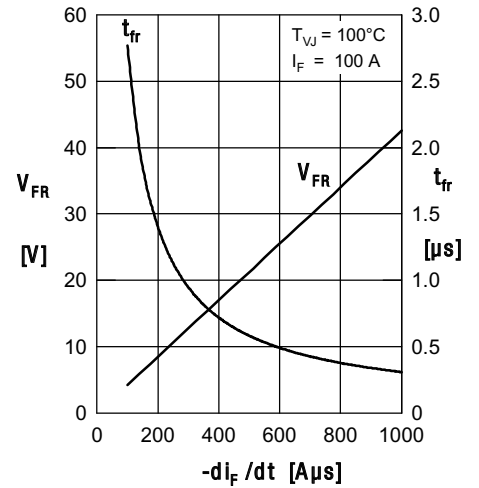
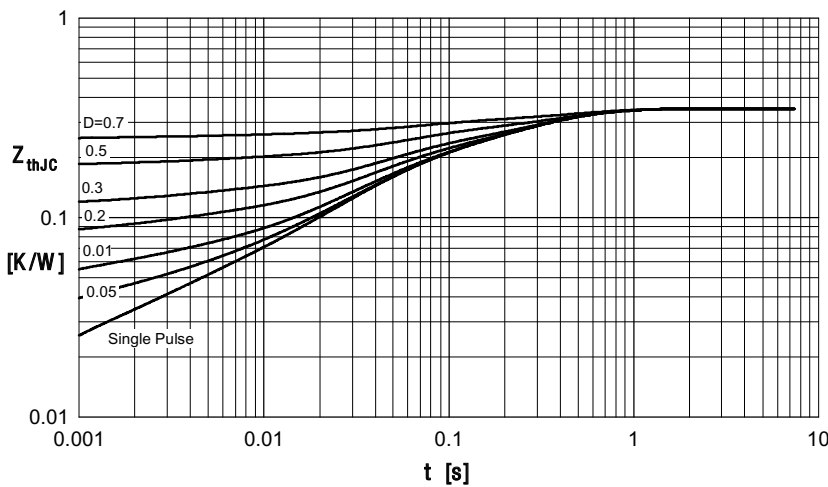
 Fig. 5 Recovery time  $t_{rr}$  versus  $-di_F/dt$ 

 Fig. 6 Peak forward voltage  $V_{FR}$  and  $t_{fr}$  versus  $-di_F/dt$ 

Fig. 7 Transient thermal resistance junction to case at various duty cycles

 Constants for  $Z_{thjC}$  calculation:

i	$R_{thi}$ (K/W)	$t_i$ (s)
1	0.017	0.00038
2	0.0184	0.0026
3	0.1296	0.0387
4	0.185	0.274