

MAX31827/MAX31828/ MAX31829

Low-Power Temperature Switch with I²C Interface

General Description

The MAX31827 is a $\pm 1^{\circ}\text{C}$ accuracy from -40°C to $+125^{\circ}\text{C}$ (12 bits) local temperature switch and sensor with I²C/SMBus interface. The combination of small 6-bump wafer-level package (WLP) and high accuracy makes this temperature sensor/switch ideal for a wide range of applications. It can be used as a temperature switch with preconfigured thresholds and/or as a temperature sensor with I²C interface. When the part operates as an independent temperature switch, the I²C interface doesn't have to be used. This enables use of the part in systems that require thermal protection implemented in hardware, without the need for reconfiguration or use of software/firmware during normal operation.

One-time programmable (OTP) ALARM functionality enables use of the part as a safety mechanism in systems where power dissipation is a challenge.

The I²C/SMBus-compatible serial interface accepts standard write and read commands to read the temperature data and configure the behavior of the sensor. Bus timeout resets the interface if the clock is low for more than 30ms (nominal). Packet error checking (PEC) helps prevent communication errors when used with a master that supports this feature.

The MAX31827 is available in a 6-bump WLP and operates over the -45°C to $+145^{\circ}\text{C}$ temperature range.

Applications

- Battery-Powered Equipment
- Handheld Electronics
- Data Communications Equipment
- Servers
- Industrial Equipment

Benefits and Features

- Stand-alone Temperature Switch with Preconfigured Alarm Thresholds and Hysteresis
- Active High/Active Low/Open Drain ALARM Output
- Excellent Temperature Accuracy
 - Maximum $\pm 1.75^{\circ}\text{C}$ from -45°C to $+145^{\circ}\text{C}$
 - Maximum $\pm 1^{\circ}\text{C}$ from -40°C to $+125^{\circ}\text{C}$ (12 bits)
- External Resistor Selects Address for Location Identification
- Temperature Resolution is Selectable from 8 to 12 Bits
- Selectable Timeout Prevents Bus Lockup (Default Enabled)
- I²C and SMBus Support
- User-Defined Alarm Settings
- Selectable PEC for Reliable Communications
- Up to 1MHz Bus Speed
- +1.6V to +3.6V Power Supply Voltage

Simplified Block Diagram

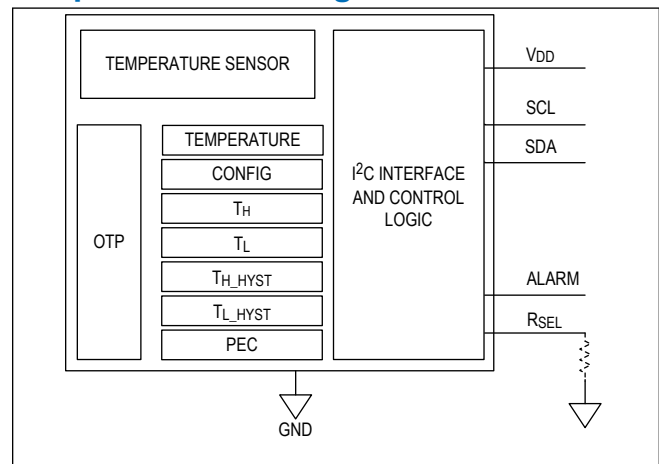

TABLE OF CONTENTS

General Description	1
Applications	1
Benefits and Features	1
Simplified Block Diagram	1
Absolute Maximum Ratings	6
Package Information	6
WLP	6
Electrical Characteristics	7
Typical Operating Characteristics	9
Pin Configuration	10
WLP Package Pinout	10
Pin Description	10
Detailed Description	11
Measuring Temperature	11
Address	11
ADDRESS MAP	12
Temperature Data	12
Configuration/Status Register	13
One-Shot	13
Conversion Rate	13
PEC	14
Timeout	14
Resolution	14
ALARM Polarity	14
Comparator/Interrupt	15
Fault Queue	16
PEC Error	16
Under Temperature Status	16
Over Temperature Status	16
Default Power-On Reset Configuration	16
Temperature Threshold Alarm Registers	16
Alarm Hysteresis Thresholds	16
I ² C-Compatible Bus Interface	17
Applications Information	19
Power Supply Current, Resolution, and Conversion Rate	19
Temperature-Sensing Considerations	19
PEC Usage Considerations	19
Selector Guide	20
Ordering Information	21

TABLE OF CONTENTS (CONTINUED)

Revision History 22

LIST OF FIGURES

Figure 1. OT/UT Status Bits and ALARM Pin Behavior (Fault Queue = 1, ALARM Polarity = 0).....	15
Figure 2. I ² C/SMBus Timing Diagram.	17
Figure 3. 2-Byte Write to MAX31827.	17
Figure 4. 2-Byte Write to MAX31827 with PEC Byte.	17
Figure 5. 2-Byte Read from MAX31827.....	18
Figure 6. 2-Byte Read from MAX31827 with PEC Byte.....	18

LIST OF TABLES

Table 1. Resistor Selection of Address Bits A4:A0	11
Table 2. Register Functions	12
Table 3. Temperature Data Format (S = Sign Bit).	12
Table 4. Temperature/Data Relationship for 12-bit Resolution	13
Table 5. Configuration Register Definition.	13
Table 6. Conversion Rate Selection	14
Table 7. Resolution Selection	14
Table 8. Fault Queue Selection.	16
Table 9. Temperature Threshold Selector.	20
Table 10. Power Up Conversion Rate.	20
Table 11. Power On Settings	20

Absolute Maximum Ratings

V _{DD} to GND.....	-0.3V to +4V	Operating Temperature Range	-45°C to +145°C
RSEL, ALARM, SCL, SDA to GND	-0.3V to +4V	Storage Temperature Range	-60°C to +150°C
Continuous Power Dissipation (Multilayer Board, T _A = +70°C, derate 10.51mW/°C above +70°C).....	10.51mW	Soldering Temperature (reflow)	+260°C

Stresses beyond those listed under "Absolute Maximum Ratings" may cause permanent damage to the device. These are stress ratings only, and functional operation of the device at these or any other conditions beyond those indicated in the operational sections of the specifications is not implied. Exposure to absolute maximum rating conditions for extended periods may affect device reliability.

Package Information

WLP

Package Code	N61B1+1
Outline Number	21-100515
Land Pattern Number	N/A
Thermal Resistance, Four-Layer Board:	
Junction to Ambient (θ_{JA})	95.15
Junction to Case (θ_{JC})	N/A

For the latest package outline information and land patterns (footprints), go to www.maximintegrated.com/packages. Note that a "+", "#", or "-" in the package code indicates RoHS status only. Package drawings may show a different suffix character, but the drawing pertains to the package regardless of RoHS status.

Package thermal resistances were obtained using the method described in JEDEC specification JESD51-7, using a four-layer board. For detailed information on package thermal considerations, refer to www.maximintegrated.com/thermal-tutorial.

Electrical Characteristics

(T_A = -40°C to +125°C, V_{DD} = 1.6V to 3.6V, resolution = 12 bits, unless otherwise specified. Limits are 100% tested at T_A = +25°C. Limits over the operating temperature range and relevant supply voltage range are guaranteed by design and characterization.)

PARAMETER	SYMBOL	CONDITIONS	MIN	TYP	MAX	UNITS
Temperature Measurement Error		-45°C to +145°C, 6-sigma	-1.75	±0.3	+1.75	°C
		-40°C to +125°C, 6-sigma	-1		+1	
Conversion Time		10-bit (+0.25°C) resolution		35	150	ms
Temperature Resolution		12 bits (Configuration bits D6:D5 = 11)		0.0625		°C
		10 bits (Configuration bits D6:D5 = 10)		0.25		
		9 bits (Configuration bits D6:D5 = 01)		0.5		
		8 bits (Configuration bits D6:D5 = 00)		1.0		
First Conversion Completed		After V _{DD} exceeds 1.6V			500	ms
Power Supply						
Operating Supply Voltage Range			1.6		3.6	V
Conversion Power Supply Current		Active temperature conversions, I ² C inactive		80	150	μA
Average Power Supply Current		I ² C inactive, 0.25 conversions/s, 10-bit (+0.25°C) resolution		5	15	μA
		I ² C inactive, 4 conversions/s, 10-bit (+0.25°C) resolution		9.8	24	
Standby Supply Current		In Standby and between conversions, I ² C bus inactive, bus timeout disabled, TA < +85°C		2	6	μA
		In Standby and between conversions, I ² C bus inactive, bus timeout enabled, TA < +125°C		3.5	15	μA
LOGIC (SDA, SCL) DC Characteristics						
Input High Voltage	V _{IH}	V _{DD} = 1.6V		$\frac{V_{DD} \times 0.8}{0.8}$	3.6	V
	V _{IH}	V _{DD} = 3.3V		$\frac{V_{DD} \times 0.7}{0.7}$	3.6	V
Input Low Voltage	V _{IL}		-0.5		$\frac{V_{DD} \times 0.3}{0.3}$	V
Input High Leakage Current	I _{IH}	V _{IN} = V _{DD}			+1	μA
Input Low Leakage Current	I _{IL}	V _{IN} = 0V	-1	±0.005	+1	μA
Input Capacitance	C _{IN}			5		pF
Output High Leakage Current		V _{OUT} = V _{DD}		±0.005	1	μA
Sink Current	I _L	V _{I/O} = 0.4V	V _{DD} < 2.3V	2.5		mA
			V _{DD} > 2.3V	4		
AC Electrical Characteristics						
Serial Clock Frequency	f _{SCL}	Timeout enabled.	20		1M	Hz

Electrical Characteristics (continued)

(T_A = -40°C to +125°C, V_{DD} = 1.6V to 3.6V, resolution = 12 bits, unless otherwise specified. Limits are 100% tested at T_A = +25°C. Limits over the operating temperature range and relevant supply voltage range are guaranteed by design and characterization.)

PARAMETER	SYMBOL	CONDITIONS	MIN	TYP	MAX	UNITS
Bus Free Time Between Start and Stop Conditions	t _{BUF}		0.5			μs
START Condition Hold Time	t _{HD:STA}		0.26			μs
STOP Condition Setup Time	t _{SU:STO}	90% of SCL to 10% of SDA	0.26			μs
Clock Low Period	t _{LOW}		0.5			μs
Clock High Period	t _{HIGH}		0.26			μs
START Condition Setup Time	t _{SU:STA}	90% of SCL to 90% of SDA	0.26			μs
Data Setup Time	t _{SU:DAT}	10% of SDA to 10% of SCL	50			ns
Data In Hold Time	t _{HD:DAT}	10% of SCL to 10% of SDA	0			μs
SCL/SDA Rise Time	t _R				120	ns
SCL/SDA Fall Time	t _F	Note 1	20 x (V _{DD} /5.5 V)		120	ns
SCL Time Low for Reset of Serial Interface	t _{TIMEOUT}	Note 2	10		85	ms

Note 1: C_B = total capacitance of one bus line in pF. Tested with C_B = 400pF.

Note 2: Holding the SCL line low for a time greater than t_{TIMEOUT} causes the devices to reset SDA to the idle state of the serial bus communication (SDA released).

Typical Operating Characteristics

(TA = -40°C to +125°C, V_{DD} = 1.6V to 3.6V, resolution = 12 bits, unless otherwise specified. Limits are 100% tested at TA = +25°C. Limits over the operating temperature range and relevant supply voltage range are guaranteed by design and characterization.)

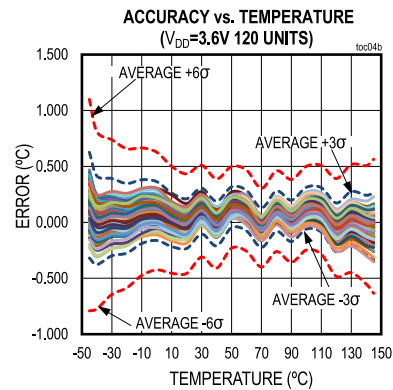
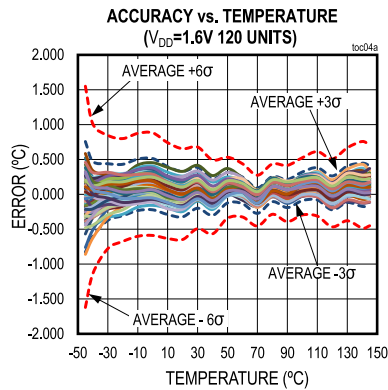
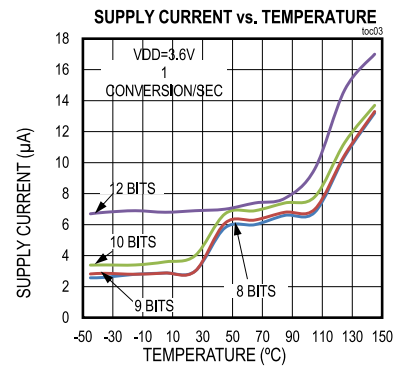
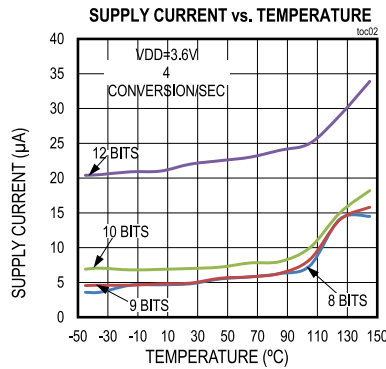
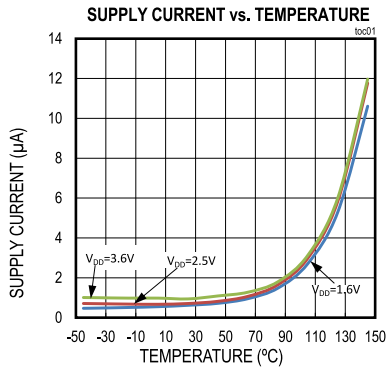

Pin Configuration

WLP Package Pinout

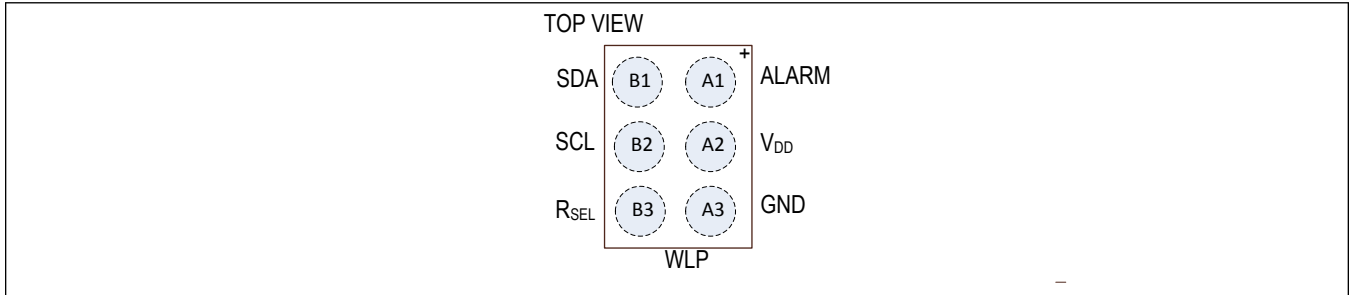

Pin Description

PIN	NAME	FUNCTION
A1	ALARM	Alarm output. Active when the temperature measured is above the TH or below TL thresholds. Configurable active high/low. It is an open-drain output and requires a pull-up resistor to operate.
A2	V _{DD}	Power Supply. Connect a 0.1μF decoupling capacitor to GND.
A3	GND	Ground return path
B1	SDA	I ² C bus data line
B2	SCL	I ² C clock
B3	R _{SEL}	Connect a resistor between this pin and GND. Used to uniquely identify up to 32 slave devices connected on the same I ² C bus. Connect to GND if only one device is used.

Detailed Description

The MAX31827 digital temperature switch/thermometer provides 12-bit temperature measurements and asserts the ALARM output when the measured temperature is outside of the programmed range defined by the low and high temperature registers, TL and TH. The temperature data is also available to be read by a host microcontroller using the I²C bus. Multiple register settings allow a host to configure the part for automatic temperature measurements, change the ALARM thresholds and hysteresis, and configure the polarity of the ALARM output. Upon power up, default OTP values are loaded into the TL, TH, TL_HYST, TH_HYST registers. This allows the operation of the MAX31827 as a thermal protection device without firmware intervention. See the [Ordering Information](#) section for the available options.

Measuring Temperature

A resolution of 8-, 9-, 10-, or 12-bits can be selected using the configuration register. 8-bit resolution corresponds to an LSB value of +1°C, while 12-bit resolution corresponds to a least-significant byte (LSB) value of +0.0625°C. The sensor powers up in a preconfigured state. Selecting different configurations can be done by ordering a different part option as shown in the [Ordering Information](#) table.

Address

The MAX31827 supports the I²C 7-bit addressing scheme. The temperature sensor includes an R_{SEL} address pin, which can be connected to an external resistor in order to uniquely identify up to 32 devices connected on the same I²C bus. The resistor value is measured at power up. Mapping of the address selection resistor value to A4:A0 is shown in the table below. Connect this pin to GND if only one device is used.

Table 1. Resistor Selection of Address Bits A4:A0

A4:A0	1% RESISTOR VALUE (kΩ)
11111	4.2
11110	5
11101	5.9
11100	7.1
11011	8.4
11010	10
11001	11.9
11000	14.1
10111	16.8
10110	20
10101	23.8
10100	28.3
10011	33.6
10010	40
10001	47.6
10000	56.6
01111	67.3
01110	80
01101	95.1
01100	113.1
01011	134.5
01010	160

Table 1. Resistor Selection of Address Bits A4:A0 (continued)

01001	190.3
01000	226.3
00111	269.1
00110	320
00101	380.5
00100	452.5
00011	538.2
00010	640
00001	761.1
00000	905.1

The upper two bits are fixed to the values 10. For example, a device that uses a value of 905kΩ responds to the slave address 1000000.

ADDRESS MAP

The control and data registers are organized as shown in Table 2. All memory commands are described in detail in the Function Commands section.

Table 2. Register Functions

OFFSET	READ OR WRITE	REGISTER NAME		FUNCTION COMMANDS
0x00	R	T_MSB	T_LSB	Temperature 16-bit word
0x02	R/W	CONFIGURATION / STATUS		Configuration/Status
0x04	R/W	TH_MSB	TH_LSB	Alarm threshold high 16-bit word
0x06	R/W	TL_MSB	TL_LSB	Alarm threshold low 16-bit word
0x08	R/W	TH_HYST_MSB	TH_HYST_LSB	Hysteresis high threshold 16-bit word
0x0A	R/W	TL_HYST_MSB	TL_HYST_LSB	Hysteresis low threshold 16-bit word

Temperature Data

The temperature data format produces values up to and beyond the +150°C operating limit.

Table 3. Temperature Data Format (S = Sign Bit)

MOST SIGNIFICANT BYTE (°C)								LEAST SIGNIFICANT BYTE (°C)							
D7	D6	D5	D4	D3	D2	D1	D0	D7	D6	D5	D4	D3	D2	D1	D0
S	S	S	S	128	64	32	16	8	4	2	1	0.5	0.25	0.125	0.0625

Table 4. Temperature/Data Relationship for 12-bit Resolution

TEMPERATURE (°C)	DATA FORMAT (BINARY)	DATA FORMAT (HEX)
+150	0000 1001 0110 0000	0960h
+128	0000 1000 0000 0000	0800h
+125	0000 0111 1101 0000	07D0h
+85	0000 0101 0101 0000	0550h
+25.0625	0000 0001 1001 0001	0191h
+10.125	0000 0000 1010 0010	00A2h
+0.5	0000 0000 0000 1000	0008h
0	0000 0000 0000 0000	0000h
-0.5	1111 1111 1111 1000	FFF8h
-10.125	1111 1111 0101 1110	FFF8h
-25.0625	1111 1110 0110 1111	FE6Fh
-55	1111 1100 1001 0000	FC90h

Configuration/Status Register

The configuration/status register contains 16 bits of data and can be used to initiate single conversions (one-shot), enable bus timeout, enable PEC, control the temperature measurement resolution, control the shutdown, configure the ALARM active state, and select the automatic conversion rate. Some of the bits in this register are used to report the status of the part and are defined as read-only. See Table 5 below for details.

Table 5. Configuration Register Definition

D15	D14	D13	D12	D11	D10	D9	D8	D7	D6	D5	D4	D3	D2	D1	D0
Over Temp Status	Under Temp Status	PEC Error	Not Used	Fault Queue	Comp/Int	Alarm Polarity	Resolution	Timeout	PEC Enable	Conversion Rate	One-Shot				

One-Shot

The one-shot function helps reduce the average supply current when continuous conversions are not necessary. Before setting this bit, the application needs to reset the Conversion Period bits. Writing a 1 to D0 while in shutdown mode immediately prompts a new temperature conversion. After the conversion is complete, the device returns to shutdown mode and D0 automatically resets. If needed, the host can check the status of the one-shot bit to detect when the conversion is complete. If the device is configured for automatic sampling mode, and a conversion is in progress at the time a one-shot command is issued, it will wait for the current conversion to complete before starting a new sequence. If the part is in automatic sampling mode but a conversion is not in progress, the one-shot command starts immediately. The host is able to reset the automatic conversion period and set the one-shot bit using a single write command to the configuration/status register.

Conversion Rate

The Conversion Rate bits, D3:D1, select the rate for automatic continuous conversions. Rates between 1 conversion/64 sec and 8 conversions/sec are available. The nominal conversion time is 35ms at the default resolution of 10 bits. In automatic conversion mode, shutdown mode is entered between conversions to reduce the average power supply current. Writing a value of 0b000 to this field causes the MAX31827 to enter shutdown mode. If a conversion is in progress at the time the value in this field is set to 0b000, the state of the machine allows the conversion to finish before entering shutdown.

Table 6. Conversion Rate Selection

D3	D2	D1	CONVERSION RATE
0	0	0	0 (Shutdown)
0	0	1	1 conversion/64 second
0	1	0	1 conversion/32 second
0	1	1	1 conversion/16 second
1	0	0	1 conversion/4 second
1	0	1	1 conversion/second (default)
1	1	0	4 conversion/second
1	1	1	8 conversion/second

PEC

Set D4 to enable packet error checking (PEC). When enabled, a PEC byte is appended to the end of each message transfer. This is a CRC-8 byte that is calculated on all of the message bytes (including the address/read/write byte). The last device to transmit a data byte also transmits the PEC byte. The master transmits the PEC byte after a write transaction, and the MAX31827 transmits the PEC byte after a read transaction. See [Figure 3](#) and [Figure 5](#) for details.

Timeout

Write 1 to D5 to disable bus timeout.

Write 0 to D5 to enable bus timeout. Bus timeout resets the I²C-compatible interface when SCL is low for more than 30ms (nominal).

Resolution

The Resolution bits (D7:D6) select the conversion resolution. The conversion time doubles with every bit of increased resolution. For example, the nominal 10-bit conversion time is 35ms. Increasing the resolution to 12 bits increases the conversion time to 140ms. The resolution bits allow resolution, conversion time, and supply current to be optimized for the application's requirements. The bits in this field must only be changed when the MAX31827 is in shutdown mode.

Table 7. Resolution Selection

D7	D6	RESOLUTION
0	0	8 bit
0	1	9 bit
1	0	10 bit
1	1	12 bit(Default)

ALARM Polarity

When D8 is 0, the ALARM active state is low. The ALARM output is driven low when the temperature is above T_H or below T_L .

When D8 is 1, the ALARM active state is high. The ALARM pin is pulled high when the temperature is above T_H or below T_L .

If the hysteresis thresholds are programmed, after a temperature alarm, the ALARM pin status changes when the temperature falls below T_{H_HYST} or above T_{L_HYST} .

Note: The behavior for both settings is dependent on the Fault Queue setting. The ALARM pin is an open-drain output and requires a pullup resistor to operate.

Comparator/Interrupt

Set the D9 Comparator/Interrupt bit to 0 to make the Overtemperature status (OT and UT status) bits operate in Comparator mode. In Comparator mode, the OT/UT status bits have a value of 1 when the temperature rises above the T_H value or falls below T_L , which is also subject to the Fault Queue selection. OT status returns to 0 when the temperature drops below the T_{H_HYST} value or when shutdown mode is entered. Similarly, UT status returns to 0 when the temperature rises above T_{L_HYST} value or when shutdown mode is entered.

Set bit D9 to 1 to operate OT/UT status bits in Interrupt mode. Exceeding T_H in this mode also sets OT status to 1, which remains set until a read operation is performed on the configuration/status register; at this point, it returns to 0. Once OT status is set to 1 from exceeding T_H and reset, it is set to 1 again only when the temperature drops below T_{H_HYST} . The output remains asserted until it is reset by a read. It is set again if the temperature rises above T_H , and so on. The same logic applies to the operation of the UT status bit.

Putting the MAX31827 into shutdown mode also resets the OT/UT status bits. Note that if the mode is changed while OT/UT status bits are set, an OT/UT status reset may be required before it begins to behave normally. To prevent this, it is recommended to perform a read of the configuration/status register to clear the status bits before changing the operating mode.

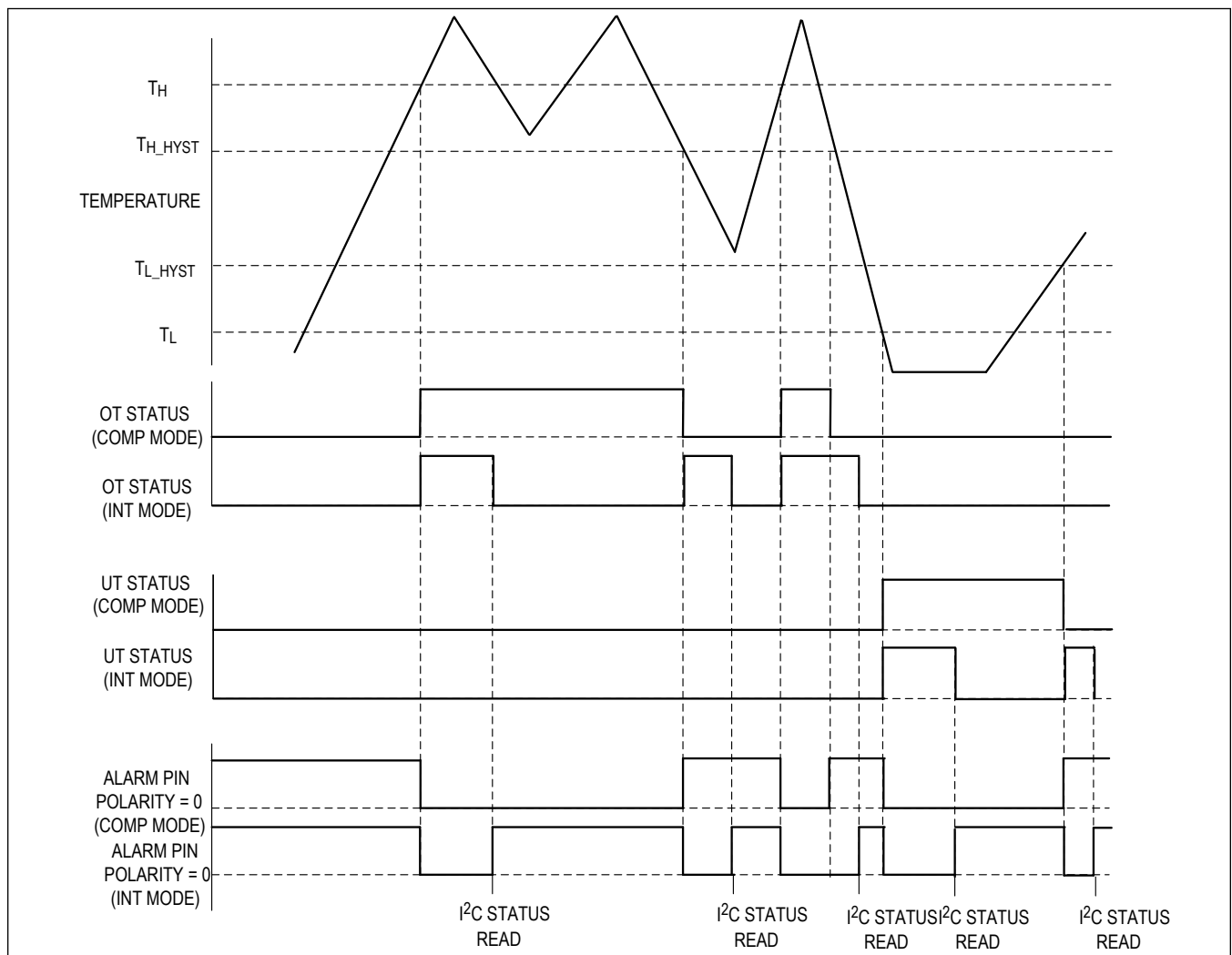

Figure 1. OT/UT Status Bits and ALARM Pin Behavior (Fault Queue = 1, ALARM Polarity = 0).

Fault Queue

The Fault Queue bits (D11:D10) select how many consecutive temperature faults must occur before overtemperature or undertemperature faults are T_H indicated in the corresponding status bits. The fault queue selection applies to both Comparator and Interrupt modes. The Fault Queue counter resets any time the temperature falls below T_H or rises above T_L. The fault counter does not change when the measured temperature drops below T_{H_HYST} or is above T_{L_HYST} thresholds. In Interrupt mode, clearing the fault conditions is done using an I²C transaction by reading the configuration/status register. In Comparator mode, the flags reset when the temperature measured is between T_{L_HYST} and T_{H_HYST} thresholds.

Table 8. Fault Queue Selection

D11	D10	# FAULTS
0	0	1 (Default)
0	1	2
1	0	4
1	1	8

PEC Error

This bit is read-only. It is set to 1 by the device when the PEC enable bit is set. During an I²C transaction, the PEC value calculated by the device does not match the value sent by the host. When the PEC enable bit is 0, it remains 0.

Under Temperature Status

D14 is a read-only bit that indicates the temperature value is under the T_L threshold. Its behavior is controlled by the Comparator/Interrupt and Fault Queue bits.

Over Temperature Status

D15 is a read-only bit that indicates that the temperature value is exceeding the value in the T_H register. Its behavior is controlled by the Comparator/Interrupt and Fault Queue bits.

Default Power-On Reset Configuration

The configuration register always powers up to a known state, as indicated in the [Ordering Information](#) section. Consult the factory if a desired configuration is not listed.

Temperature Threshold Alarm Registers

Addresses 0x04 and 0x06 contain the 16-bit alarm thresholds, T_H and T_L. The default values for these registers are loaded at power-up and depend on the part option selected. Refer to the [Ordering Information](#) section for available options. The data format is the same as that of the temperature register. Once the part is powered up, the values can be changed using the I²C interface. The memory used to store the settings is volatile, and the content of the registers is not retained if the power is powered down.

Note: Before the register values are changed over I²C, the part must be in shutdown mode. See the [Configuration/Status Register](#) section for details. Operation in Automatic mode can resume after the register update.

Alarm Hysteresis Thresholds

Addresses 0x08 and 0x0A contain the 16-bit alarm hysteresis thresholds, T_{H_HYST} and T_{L_HYST}. The default values for these registers are loaded at power up and depend on the part option selected. The data format is the same as that of the temperature register. Once the part is powered up, the values can be changed using the I²C interface. The memory used to store the settings is volatile and the content of the registers is not stored upon power down.

Notes:

T_{H_HYST} is intended to have values less than or equal to T_H, and T_{L_HYST} value has to be equal of higher than T_L for the part to operate correctly.

Before the register values are changed over I²C, the part has to be placed in Shutdown mode. Refer to the Configuration/Status Register Conversion Rate field for details. Operation in automatic mode can resume after the register update.

I²C-Compatible Bus Interface

A standard I²C-compatible 2-wire serial interface reads temperature data from the temperature registers and reads and writes Control bits to and from the configuration registers. In addition, the interface supports useful SMBus functions, including selectable bus timeout and selectable PEC.

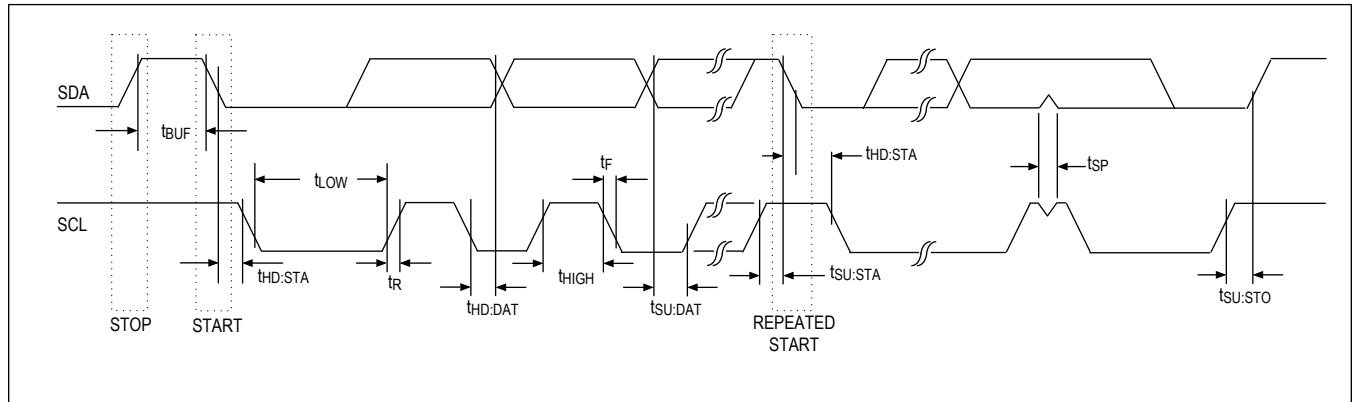

Figure 2. I²C/SMBus Timing Diagram.

Normal transactions consist of 2-byte writes and reads. An additional byte is appended when PEC is enabled. Attempting longer transactions is not recommended. A transaction always begins with a START (S) condition followed by the slave address and the Write/Read bit.

A 2-byte write transaction begins with the master generating a START condition, then transmitting the MAX31827's slave address followed by the Write bit. The MAX31827 acknowledges with an ACK (A) bit, and the master transmits the target register, followed by another ACK from the MAX31827. The master then writes the two data bytes, and the MAX31827 ACKs each. The master ends the transaction by generating a STOP (P) condition. Writing more bytes (not recommended) overwrites the register (e.g., Data High - Data Low - Data High - Data Low for a 4-byte write).

DIRECTION	M→S	M→S	M→S	S→M	M→S	S→M	M→S	S→M	M→S	S→M	M→S
BITS	1	7	1	1	8	1	8	1	8	1	1
CONTENT	S	SLAVE ADDRESS	WR	A	REGISTER SELECT	A	DATA HIGH	A	DATA LOW	A	P

Figure 3. 2-Byte Write to MAX31827.

When PEC is enabled, the write transaction is similar, except that the PEC byte (calculated using Slave Address, Register Address, Data High and Data Low) is appended by the master after the ACK bit that follows the second data byte. Any attempted write that is not a multiple of three bytes is ignored. If more than one set of three bytes is written, the PEC byte is calculated using the bytes listed above, plus the first PEC byte and the second Data High and Data Low bytes. Again, writing more than three bytes with PEC enabled is not recommended.

DIRECTION	M→S	M→S	M→S	S→M	M→S	S→M	M→S	S→M	M→S	S→M	M→S	S→M	M→S
BITS	1	7	1	1	8	1	8	1	8	1	8	1	1
CONTENT	S	SLAVE ADDRESS	WR	A	REGISTER SELECT	A	DATA HIGH	A	DATA LOW	A	PEC BYTE	A	P

Figure 4. 2-Byte Write to MAX31827 with PEC Byte.

A 2-byte read is slightly more complex than a write. After transmitting the register byte and receiving an ACK from the MAX31827, the master generates a Repeat Start (Sr) and writes the address and a Read bit. The MAX31827 then ACKs the address/read byte and transmits the two data bytes. The master ACKs the first and NACKs the second, signaling that the transaction is complete, and then generates the STOP condition.

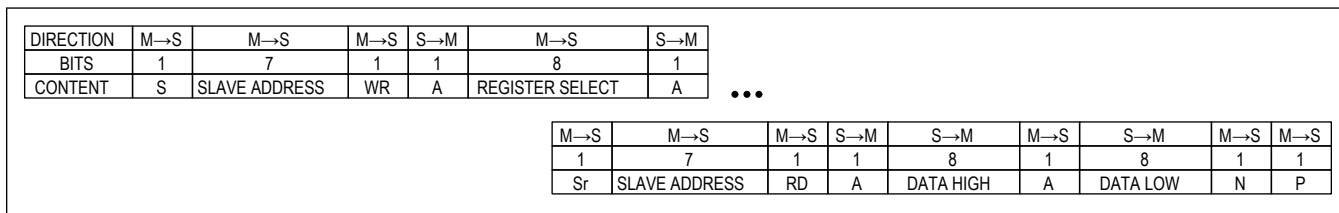

Figure 5. 2-Byte Read from MAX31827.

When PEC is enabled, the read transaction is similar, except the PEC byte is appended by the MAX31827 after the ACK bit that follows the second data byte.

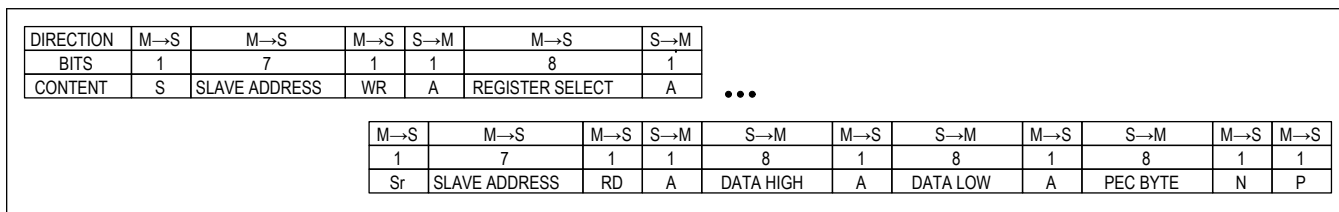

Figure 6. 2-Byte Read from MAX31827 with PEC Byte.

Applications Information

Power Supply Current, Resolution, and Conversion Rate

The MAX31827 is a low-power temperature sensor whose average power supply current is affected by the conversion resolution and rate. Understanding the relationships between these values can help to optimize performance trade-offs.

In standby mode, and between conversions, the power supply current is typically 500nA. During a conversion, the typical supply current increases to 80µA. The duration of a conversion depends on the conversion resolution selected in the configuration register. A 10-bit conversion requires a typical value of 35ms. Each 1-bit increase in resolution doubles the conversion time, and each 1-bit decrease halves the conversion time. For example, if 12-bit resolution is selected, the conversion time has a typical value of 140ms.

The conversion rate is also selectable, and along with the resolution, helps to set the conversion duty cycle and average power supply current. As an example, 10-bit conversions occurring at a rate of one conversion per second will result in an average power supply current of

$$I_{AVE} = 80\mu\text{A} \times 0.035 + 0.5\mu\text{A} \times 0.965 = 2.8\mu\text{A}$$

Trade-offs between power and resolution and conversion rate can be considered, depending on the design priorities. For example, when supply current is much more important than resolution, reducing the resolution in the example above to 8 bits will reduce the duty cycle by 75%, yielding

$$I_{AVE} = 80\mu\text{A} \times 0.00875 + 0.5\mu\text{A} \times 0.99125 = 1.27\mu\text{A}$$

When selecting resolutions and conversion rates, note that if the resolution is 12-bits, avoid the 8 conversions per second rate. The conversion time under these conditions can be longer than the time available to complete a conversion. In this case, the conversion does not complete, and the data from the last valid conversion result remains in the temperature register.

Temperature-Sensing Considerations

The MAX31827 measures the temperature of its own die. The thermal path between the die and the outside world determines the accuracy of temperature measurements. External temperature is conducted to the die primarily through the leads; thus, the PCB temperature is measured accurately. In this case, the GND connection can be a thick trace between the area that needs to be measured and the sensor.

For ambient temperature measurements, mount the sensor on a PCB (or a section of the PCB) that is at ambient temperature, separated from heat-dissipating components. If mounting it on the same board with other components that might dissipate power, place the sensor as far away from heat sources as possible. The routing to the part should be done using thin traces to avoid thermal conduction from hot zones. Similarly with multi-layer PCBs with GND and power planes, it is recommended to remove the copper from under the sensor and provide a clearance of at least 10-15 mm around it. If a sensor is installed on a separate PCB, the GND area around the part can be expanded to facilitate thermal contact with the air.

Low supply current helps to minimize temperature errors from self-heating of the sensor die.

PEC Usage Considerations

The PEC is calculated as an 8-bit cyclic redundancy check (CRC) using the following polynomial: $X^8 + X^2 + X^1$. The PEC CRC is computed in the order the bits are received and transmitted. All the bytes in a transaction, including the slave address, must be included in the calculation. The control signals START, Repeated START, STOP, ACK and NACK are not taken into account.

There are several ways to implement the CRC calculation used for PEC in the microcontroller firmware. The CRC can be calculated using shifts and/or operations or a lookup table. The trade-off is the size of the code versus processing speed. A full lookup table uses 256 bytes of flash memory, but the CRC algorithm is executed in only a few clock cycles. The calculation method has very low memory requirements, but executes much slower.

Selector Guide

Table 9.
Temperature Threshold Selector

IDENTIFIER	TEMPERATURE (°C)
A	-40
B	-30
C	-20
D	-10
E	0
F	10
G	20
H	30
K	40
L	50
M	60
N	70
O	80
P	90
R	100
S	110
T	120

Table 10. Power Up Conversion Rate

IDENTIFIER	CONVERSION RATE
A	Shutdown
B	1 conversion/64 seconds
C	1 conversion/32 seconds
D	1 conversion/16 seconds
E	1 conversion/4 seconds
F	1 conversion/second
G	4 conversions/second
H	8 conversions/second

Table 11. Power On Settings

IDENTIFIER	ALARM POLARITY	FAULT QUEUE	RESOLUTION
MAX31827	0	1	12-bit
MAX31828	0	4	12-bit
MAX31829	1	4	12-bit

Ordering Information

PART NUMBER	PACKAGE	TL	TL_HYST	TH	TH_HYST	CONV	FAULT QUEUE	ALARM POL	ADC RESOLUTION
MAX31827ANTABRPF+	6 WLP	-40°C	-30°C	+100°C	+90°C	1/sec	1	0	12
MAX31827ANTABRPF+T	6 WLP	-40°C	-30°C	+100°C	+90°C	1/sec	1	0	12
MAX31828ANTABRPF+	6 WLP	-40°C	-30°C	+100°C	+90°C	1/sec	4	0	12
MAX31828ANTABRPF+T	6 WLP	-40°C	-30°C	+100°C	+90°C	1/sec	4	0	12
MAX31829ANTABRPF+	6 WLP	-40°C	-30°C	+100°C	+90°C	1/sec	4	1	12
MAX31829ANTABRPF+T	6 WLP	-40°C	-30°C	+100°C	+90°C	1/sec	4	1	12

+ Denotes a lead (Pb)-free/RoHS-compliant package.

T = Tape and reel.

Revision History

REVISION NUMBER	REVISION DATE	DESCRIPTION	PAGES CHANGED
0	07/21	Release for Market Intro.	—
1	12/21	Update Electrical Characteristics table and Ordering Information	7, 21