



DESCRIPTION

The **FTN series** thermoplastic limit switches, conform to EN 50047, have been developed to provide a range of options including plastic cases in various sizes, a choice of snap acting, slow break/make with two contact configurations and a choice of actuator heads. The **FTN series** offers the option of rotating the head in 90° increments before installation to allow ease of mounting.

Giovenzana limit switches can be used in various applications such as crane arms, lift and elevators.

Operation of these limit switches is achieved by the sliding action of the guard or the moving object deflecting the plunger or lever.

For safety applications it's important that upon actuation, the guard or other moving objects should not pass completely over the switch and allow the plunger or lever to return to its original position.

TECHNICAL DATA - HOUSING

Made of glass- reinforced polymer, self-extinguishing, shock-proof thermoplastic resin and with double insulation



FTN Series one threaded conduit entry

Standard: M16

Protection degree

IP67 according to EN60529 with cable gland having equal or higher protection degree

GENERAL DATA

Positive opening operation	NC contact
Utilization category	AC15 B600, Snap Action AC15 B600
Min current	5V, 5mA, DC
Insulation resistance	100MΩ min (DC 500V)
Contact resistance	25mΩ max (Initial)
Enclosure material	UL approved glass-filled polybutylene terephthalate
Operating temperature	Min -25°C (-18°F) / Max 80°C (+176°F)
Mechanical life expectancy	1x10 ⁷ cycles min
Electrically life expectancy	150.000 cycles min
Vibration	IEC 68-2-6, 10-55Hz ± 1Hz, Excursion: 0.35mm, 1 octave/min
Conduit entry	Various
Fixing	2xM4

ELECTRICAL DATA

Thermal current (I _{th})	10A
Rated insulation voltage	600V AC
Rated impulse withstand volt	2500V AC
Pollution degree	3
Protection against electric shock	Class II (Double insulation)

STANDARDS & APPROVALS

Standards	EN60947-5-1, UL508, EN50047
Approvals	cULus, EAC and CCC for all applicable directives

QUALITY MARKS



MAIN FEATURES

- Conforms to EN (TUV) standards corresponding to the CE marking.
-  Positive opening operation of NC (Normally Closed) contacts conforming to IEC/EN 60947-5-1.
- Double insulation makes ground terminal unnecessary.
- Wide standard operating temperature range: -25°C to 80°C.
- Full range of actuator heads and levers suitable for safety applications.
- Sealing up to IP67.
- Wide switch variations (Snap action and slow action basic switches).
- International conduit sizes.

ACCORDING TO STANDARDS

- EN81.20** Safety contacts according to EN60947-5-1.
- EN81.50** Protection degree higher than IP4X. Mechanical endurance higher than 1x10⁶ cycles.

INSTALLATION FOR SAFETY APPLICATIONS

Use only switches marked with the symbol . Always connect the safety circuit to the **NC contact** (normally closed contacts: 11-12 / 21-22 / 31-32) as required by **EN ISO 14119 paragraph 5.4** and as stated in the standard **EN81.20 paragraph 5.11.2.2.1**.



TAKE CARE!

If not expressly indicated in this chapter, for the correct installation and utilization of all articles see the instructions given on pages 92-93.

DATA TYPE APPROVED BY UL

Utilization categories:

FTN SERIES	Q300	A600	B600	A300
		1 NC/1 NO Slow Action	2 NC Slow Action	
		1 NC/1 NO Snap Action	2 NC/1 NO Slow Action (3 poles)	3 NC Slow Action (3 poles)

Data of the housing type 1.

For all contact blocks use 60 or 75°C copper (Cu) conductor and wire size No. 14 - 18 AWG.

Terminal tightening torque of 7.1 lb in (0.8 Nm).

In conformity with standard: UL508, CSA 22.2 No. 14 - 10.



Please contact our technical service for the list of approved products.

PROTECTION CLASS

IP67 Designed to be used even in the most severe environmental situations, these devices pass the immersion test IP67 in conformity with EN 60529.

DOUBLE INSULATION

 Materials of group II, according to IEC 536, are made with double insulation. This consists of doubling the insulation capability by means of an additional divider in order to eliminate any electrical shock risk and avoid the need for any additional protections.

POSITIVE OPENING

 A limit switch complies to the specification when all the normally closed contact elements of the switch can be changed, with certainty, to the open position (no flexible link between the moving contacts and the operator of the switch, to which an actuating force is applied). Positive opening doesn't apply to NO contacts. Control switches with positive opening operation can be equipped with either slow-break or snap action contacts. In order to use different contacts on the same switch, it is necessary to electrically separate them; otherwise only one contact can be used. Every positive opening control switch must be marked on the external housing with the symbol on the left.





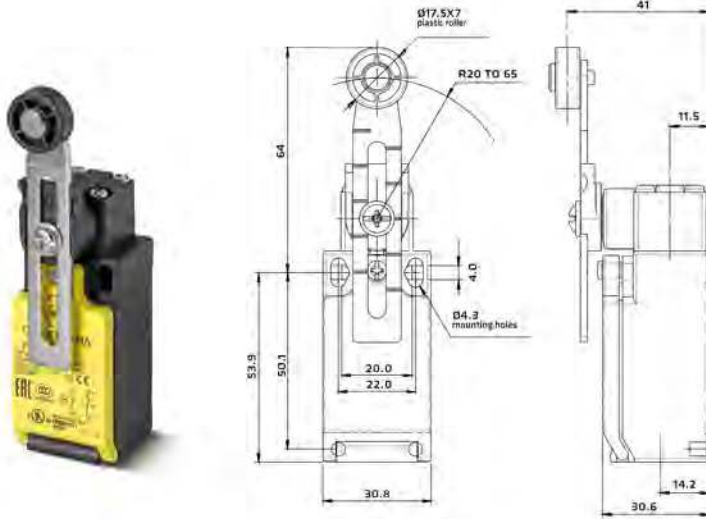

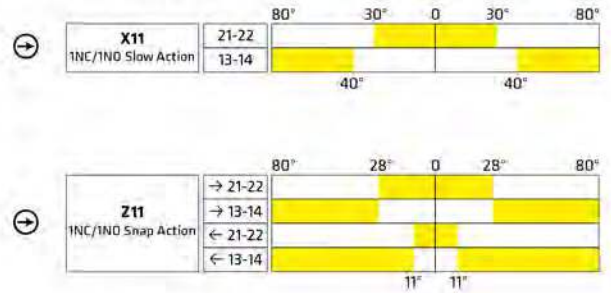

FTN144: Variable length roller lever Ø18

FTN	1	44	X11	M
Series	Function	Head and actuators	Contact Types	Thread dimension of lead exit
	1 - Without Reset Function	44 - Variable length roller lever Ø18	X11 -1NC/1NO Slow Action W02 - 2NC Slow Action Z11 -1NC/1NO Snap Action W12 - 2NC/1NO Slow Action W03 - 3NC Slow Action Slow Action & Snap Action: Type "Zb"	Standard: BLANK - M16 On request: M - M20 N - 1/2NPT G1 - PG11 G3 - PG13.5 C - Connector



OPERATION DIAGRAMS



TYPE	CONTACT BLOCK		OPERATING TRAVEL		OPERATING FORCE	POSITIVE OPENING		TOTAL TRAVEL
			PT	PT2nd	OF	Travel	Force	
	X11	1 NC/1 NO Slow Action	2.2 mm	3.0 mm	7.26 N	3.2 mm	19.0 N	6.0 mm
	W02	2 NC Slow Action	2.2 mm	-	7.42 N			
	Z11	1 NC/1 NO Snap Action	1.9 mm	-	6.71 N			
	W12	2 NC/1 NO Slow Action	2.2 mm	3.0 mm	7.26 N			
	W03	3 NC Slow Action	2.2 mm	-	7.42 N			
	X11	1 NC/1 NO Slow Action	3.0 mm	4.5 mm	5.21 N	5.7 mm	19.0 N	5.2 mm
	W02	2 NC Slow Action	3.0 mm	-	5.26 N			
	Z11	1 NC/1 NO Snap Action	2.9 mm	-	4.74 N			
	W12	2 NC/1 NO Slow Action	3.0 mm	4.5 mm	5.21 N			
	W03	3 NC Slow Action	3.0 mm	-	5.26 N			
	X11	1 NC/1 NO Slow Action	4.0 mm	6.0 mm	6.37 N	4.6 mm	19.0 N	9.8 mm
	W02	2 NC Slow Action	4.0 mm	-	6.98 N			
	Z11	1 NC/1 NO Snap Action	3.6 mm	-	5.76 N			
	W12	2 NC/1 NO Slow Action	4.0 mm	6.0 mm	6.37 N			
	W03	3 NC Slow Action	4.0 mm	-	6.98 N			
	X11	1 NC/1 NO Slow Action	2.2 mm	3.0 mm	7.26 N	3.2 mm	19.0 N	6.0 mm
	W02	2 NC Slow Action	2.2 mm	-	7.42 N			
	Z11	1 NC/1 NO Snap Action	1.9 mm	-	6.71 N			
	W12	2 NC/1 NO Slow Action	2.2 mm	3.0 mm	7.26 N			
	W03	3 NC Slow Action	2.2 mm	-	7.42 N			
	X11	1 NC/1 NO Slow Action	-	-	-	N/A	N/A	N/A
	W02	2 NC Slow Action	12°	-	6.5 N			
	Z11	1 NC/1 NO Snap Action	12°	-	5.3 N			
	W12	2 NC/1 NO Slow Action	-	-	-			
	W03	3 NC Slow Action	12°	-	6.5 N			
	X11	1 NC/1 NO Slow Action	-	-	-	N/A	N/A	N/A
	W02	2 NC Slow Action	12°	-	6.5 N			
	Z11	1 NC/1 NO Snap Action	12°	-	5.3 N			
	W12	2 NC/1 NO Slow Action	-	-	-			
	W03	3 NC Slow Action	12°	-	6.5 N			
	X11	1 NC/1 NO Slow Action	30°	41°	1.8 N	45°	19.0 N	80°
	W02	2 NC Slow Action	30°	-	1.8 N			
	Z11	1 NC/1 NO Snap Action	28°	-	1.9 N			
	W12	2 NC/1 NO Slow Action	30°	41°	1.8 N			
	W03	3 NC Slow Action	30°	-	1.8 N			
	X11	1 NC/1 NO Slow Action	30°	41°	6.5 N	45°	19.0 N	80°
	W02	2 NC Slow Action	30°	-	6.5 N			
	Z11	1 NC/1 NO Snap Action	28°	-	5.3 N			
	W12	2 NC/1 NO Slow Action	30°	41°	6.5 N			
	W03	3 NC Slow Action	30°	-	6.5 N			
	X11	1 NC/1 NO Slow Action	30°	41°	6.5 N	45°	19.0 N	80°
	W02	2 NC Slow Action	30°	-	6.5 N			
	Z11	1 NC/1 NO Snap Action	28°	-	5.3 N			
	W12	2 NC/1 NO Slow Action	30°	41°	6.5 N			
	W03	3 NC Slow Action	30°	-	6.5 N			



Your Source for Automation Components

Thermoplastic Limit Switches

TYPE	CONTACT BLOCK		OPERATING TRAVEL		OPERATING FORCE	POSITIVE OPENING		TOTAL TRAVEL
			PT	PT2nd	OF	Travel	Force	
 FTN140	X11	1 NC/1 NO Slow Action	30°	41°	5.2 N	45°	19.0 N	80°
	W02	2 NC Slow Action	30°	-	5.2 N			
	Z11	1 NC/1 NO Snap Action	28°	-	4.5 N			
	W12	2 NC/1 NO Slow Action	30°	41°	5.2 N			
	W03	3 NC Slow Action	30°	-	5.2 N			
 FTN140R	X11	1 NC/1 NO Slow Action	30°	41°	5.2 N	45°	19.0 N	80°
	W02	2 NC Slow Action	30°	-	5.2 N			
	Z11	1 NC/1 NO Snap Action	28°	-	4.5 N			
	W12	2 NC/1 NO Slow Action	30°	41°	5.2 N			
	W03	3 NC Slow Action	30°	-	5.2 N			
 FTN141	X11	1 NC/1 NO Slow Action	30°	41°	6.5 N	45°	19.0 N	80°
	W02	2 NC Slow Action	30°	-	6.5 N			
	Z11	1 NC/1 NO Snap Action	35°	-	5.3 N			
	W12	2 NC/1 NO Slow Action	30°	41°	6.5 N			
	W03	3 NC Slow Action	30°	-	6.5 N			
 FTN142	X11	1 NC/1 NO Slow Action	-	-	-	N/A	N/A	N/A
	W02	2 NC Slow Action	12°	-	5.2 N			
	Z11	1 NC/1 NO Snap Action	12°	-	4.5 N			
	W12	2 NC/1 NO Slow Action	-	-	-			
	W03	3 NC Slow Action	12°	-	5.2 N			
 FTN143	X11	1 NC/1 NO Slow Action	30°	41°	6.5 N	45°	19.0 N	80°
	W02	2 NC Slow Action	30°	-	6.5 N			
	Z11	1 NC/1 NO Snap Action	35°	-	5.3 N			
	W12	2 NC/1 NO Slow Action	30°	41°	6.5 N			
	W03	3 NC Slow Action	30°	-	6.5 N			
 FTN144	X11	1 NC/1 NO Slow Action	30°	41°	6.5 N	45°	19.0 N	80°
	W02	2 NC Slow Action	30°	-	6.5 N			
	Z11	1 NC/1 NO Snap Action	28°	-	5.3 N			
	W12	2 NC/1 NO Slow Action	30°	41°	6.5 N			
	W03	3 NC Slow Action	30°	-	6.5 N			
 FTN198	X11	1 NC/1 NO Slow Action	-	-	-			
	W02	2 NC Slow Action	-	-	-			
	Z11	1 NC/1 NO Snap Action	-	-	-			
	W12	2 NC/1 NO Slow Action	-	-	-			
	W03	3 NC Slow Action	-	-	-			