



Sales Outline Drawing

Specifications:

| | | |
|-------------------------|--|----------|
| Sound Level Category | Medium | |
| Mode of Operation | Medium Pulse @ 5 PPS | |
| Voltage Rating | 9 to 16 VDC | |
| Frequency | 3900 ± 500 Hz | |
| Loudness @ 1M | 70 to 75 dB(A) Typ. | |
| Sound Current Draw | 40mA MAX | |
| Stack Level | BOTTOM | TOP |
| LED Color | GREEN | RED |
| LED Current Draw | 25mA max | 60mA MAX |
| Total Max Current Draw | 125mA MAX | |
| Housing Material | 6/6 Nylon, Color: Black | |
| Top Cap / Lens Material | 6/6 Nylon, Color: Opaque White | |
| Storage Temperature | -40° to +70° C | |
| Operating Temperature | -30° to +60° C | |
| Mounting | Recommended hole size is 22.5 mm. | |
| Knurled Nut | The max recommended torque is 10 in-lbs. | |
| Cable | Gray, UL Style 21894, 300V, 105°C, 24AWG, Pb-Free Tinned Leads | |
| Weight (Typical) | 108 grams | |
| NEMA 12 | Approved with use of included gasket. | |
| Options | Please contact factory. | |

Dimensions: Inches (mm) **cUL Recognized** **ROHS Compliant**

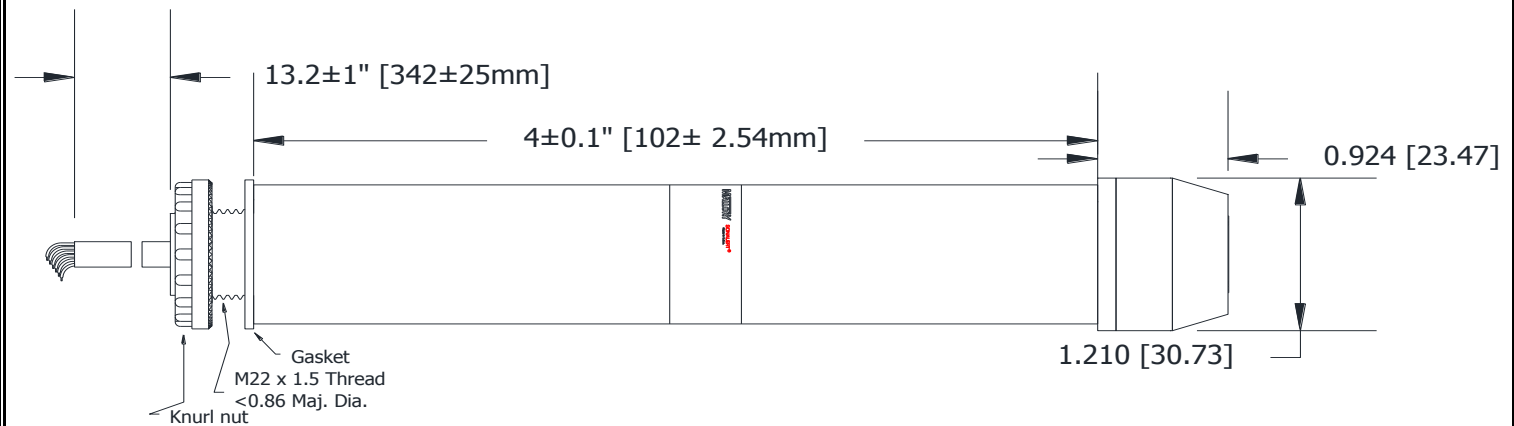

Connections:

- SOUND** BLACK wire to Ground and ORANGE wire to Positive
- BOTTOM** BROWN wire to Ground and GREEN wire to Positive
- TOP** BROWN wire to Ground and RED wire to Positive