

## GABRIELLA-MIDI-O

~12+40° oval beam with holder and installation tape

### SPECIFICATION:

Dimensions	Ø 37.8 mm
Height	24.1 mm
Fastening	tape, pin
ROHS compliant	yes ⓘ

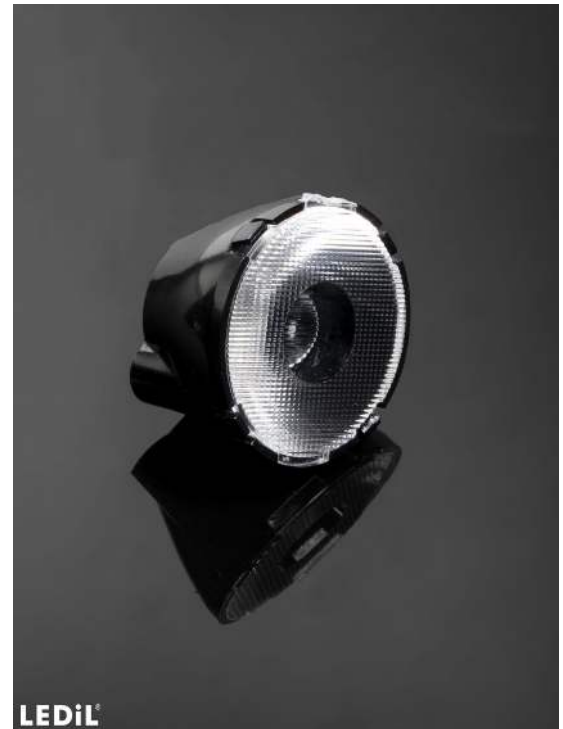

### MATERIALS:

Component	Type	Material	Colour	Finish
GABRIELLA-MIDI-O	Single lens	PMMA	clear	
GABRIELLA-MIDI-HLD	Assembly	PC	black	

### ORDERING INFORMATION:



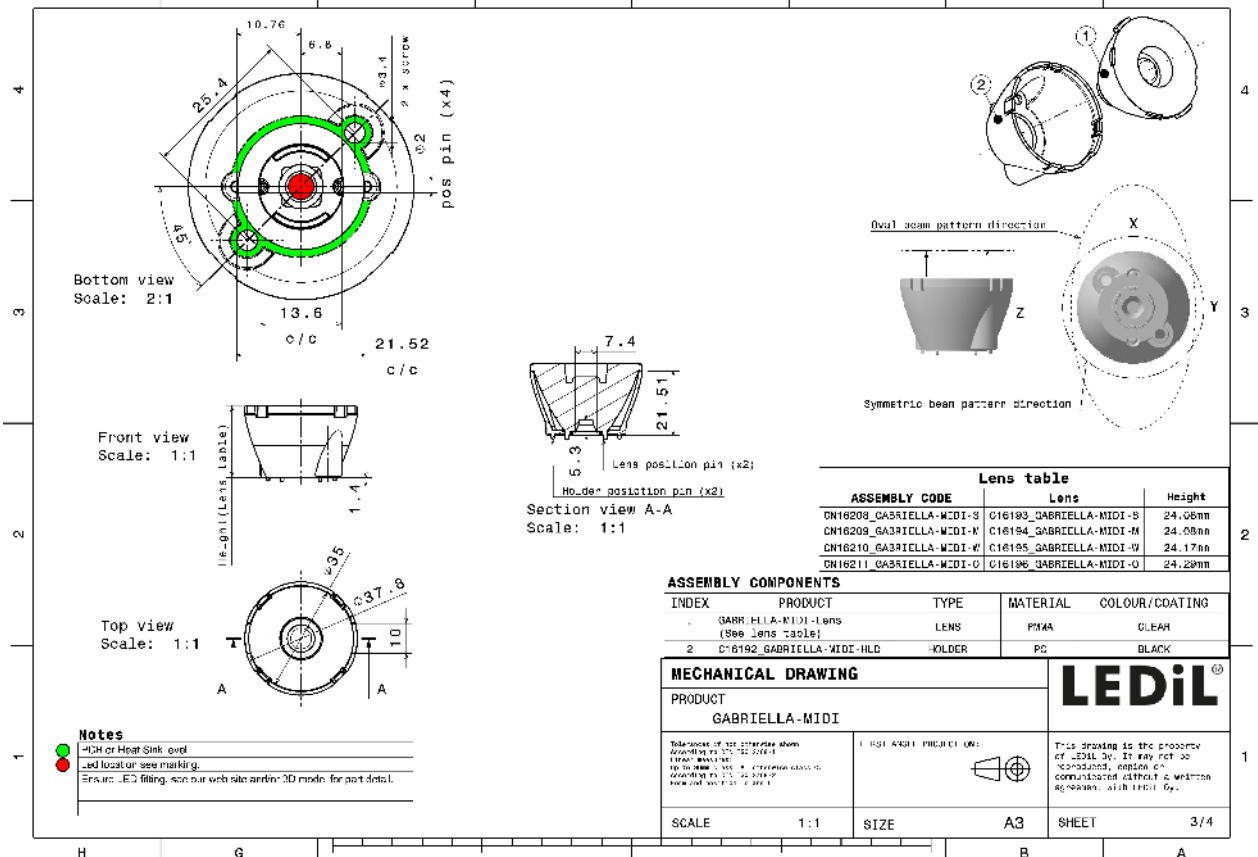
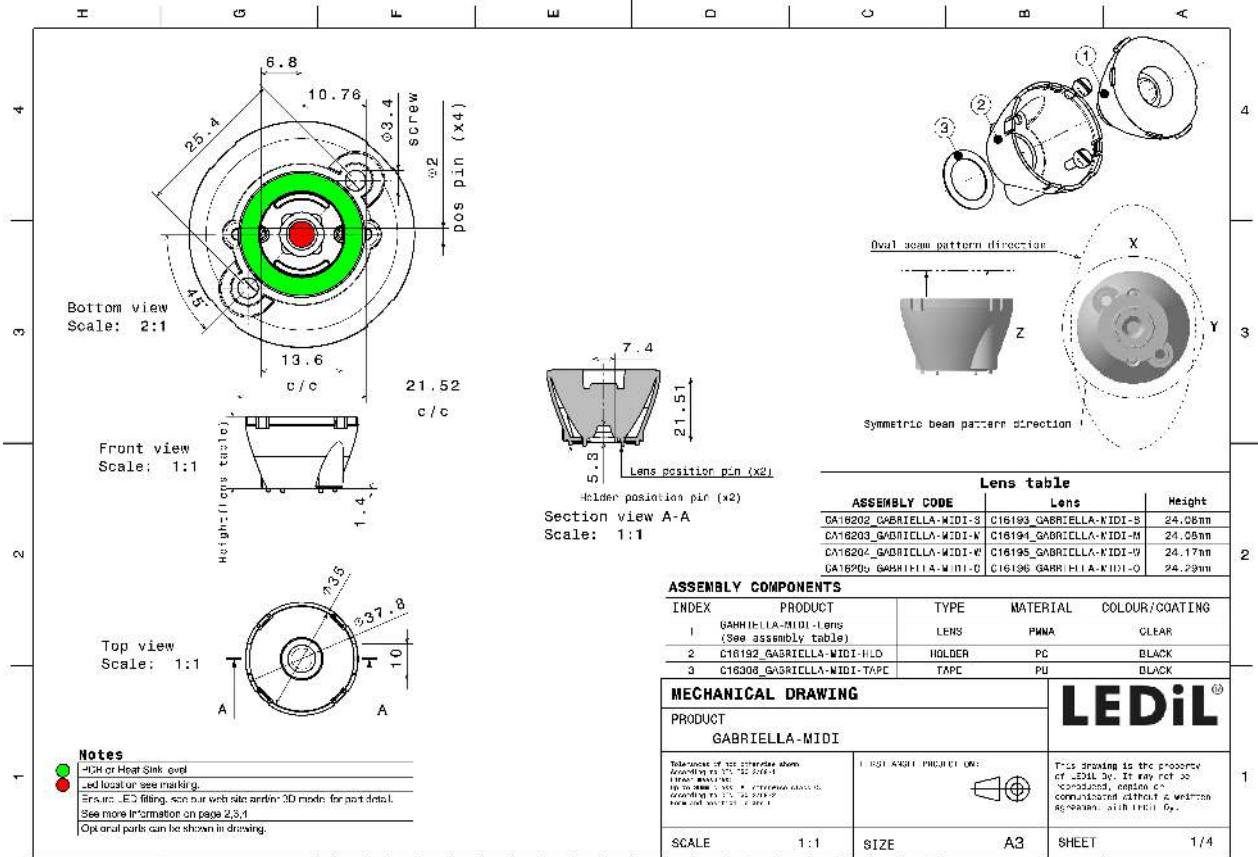

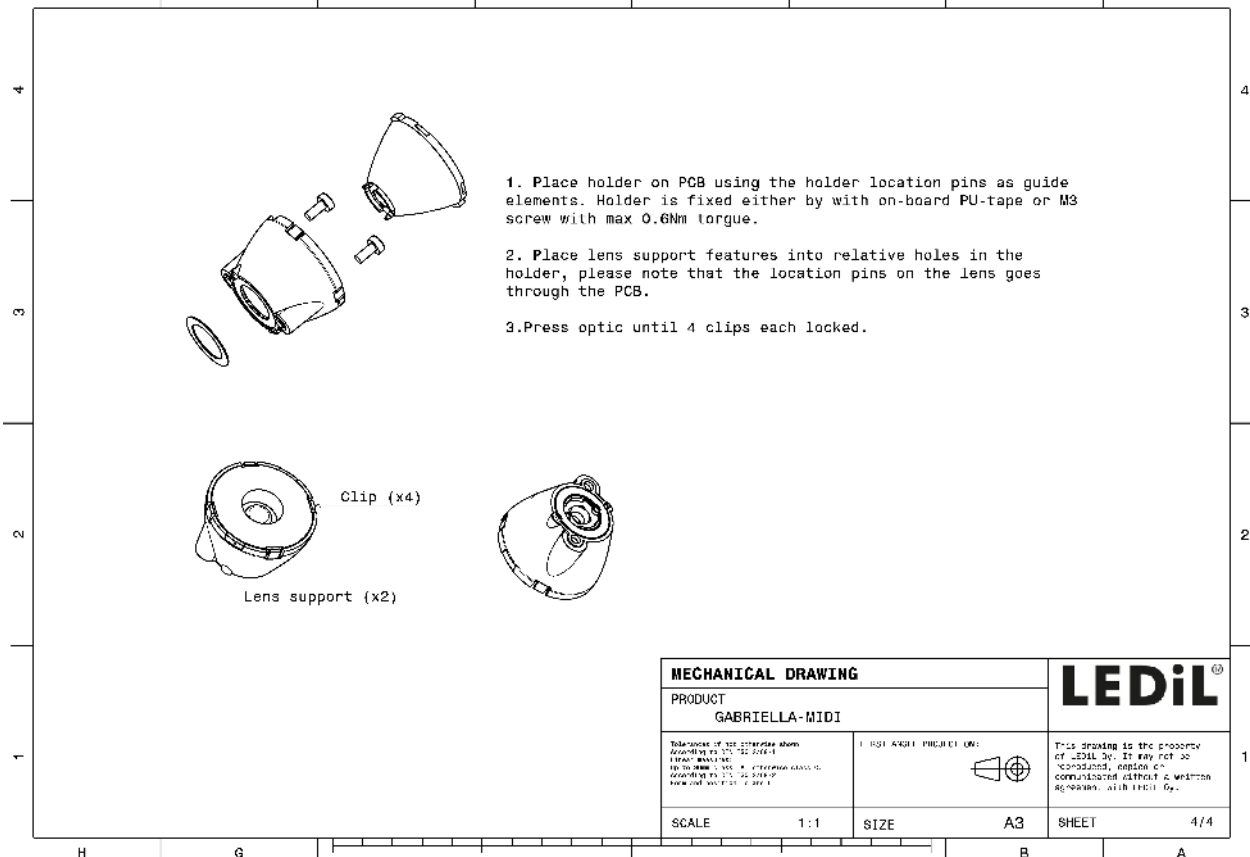
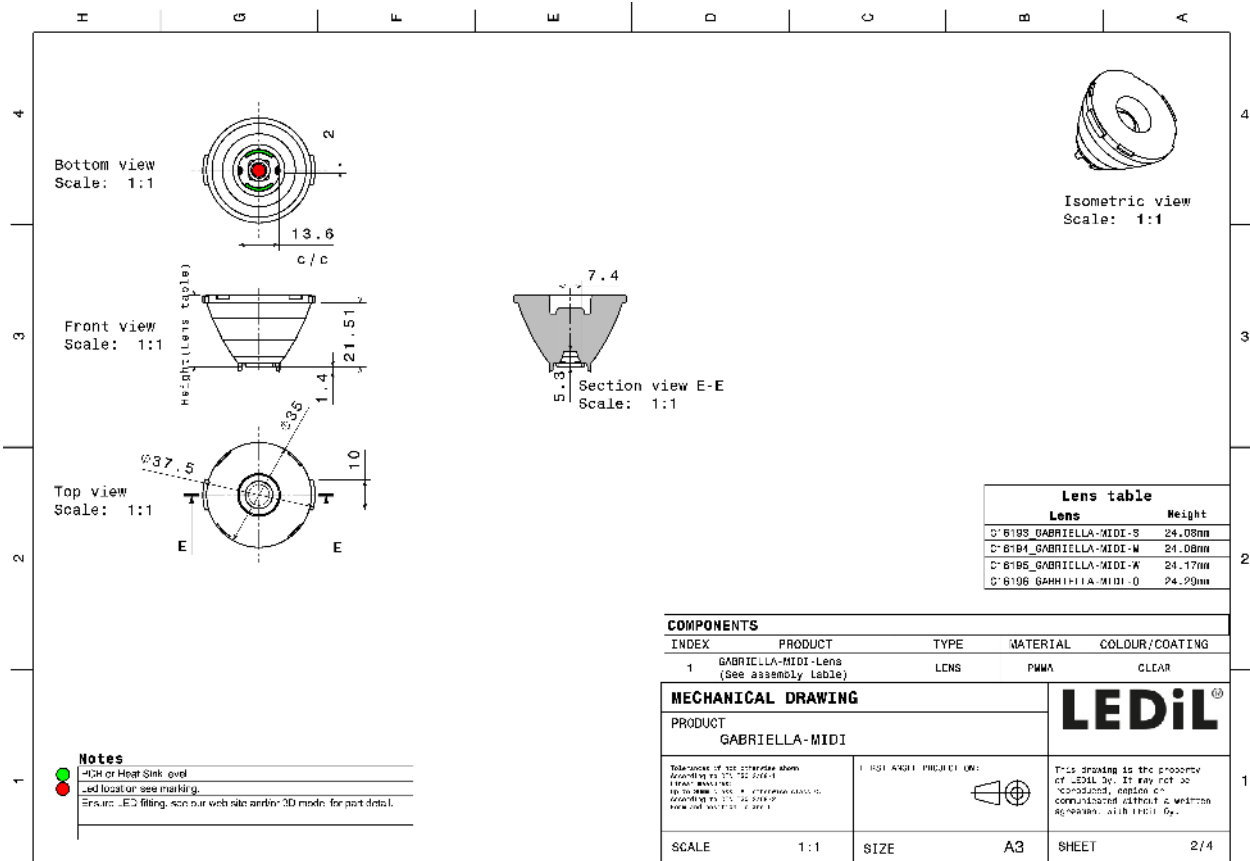
Component	Type	Qty in box	MOQ	MPQ	Box weight (kg)
CA16205_GABRIELLA-MIDI-O » Box size: 476 x 273 x 292 mm	Single lens	500	100	50	11.5





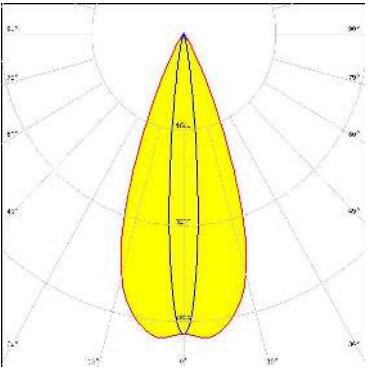

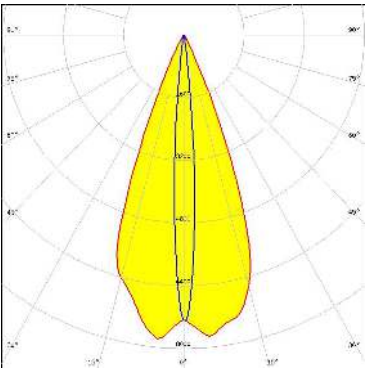
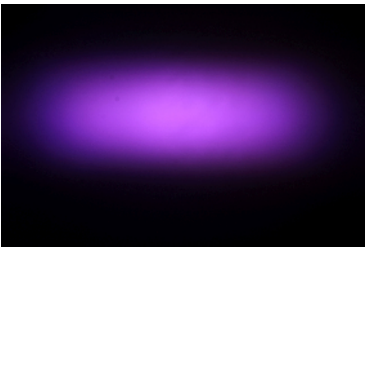
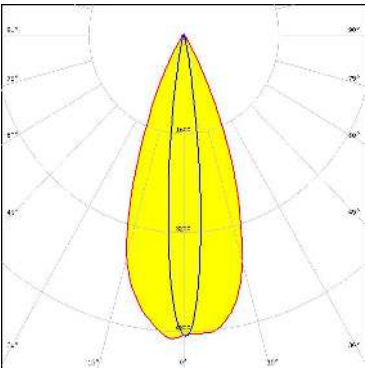

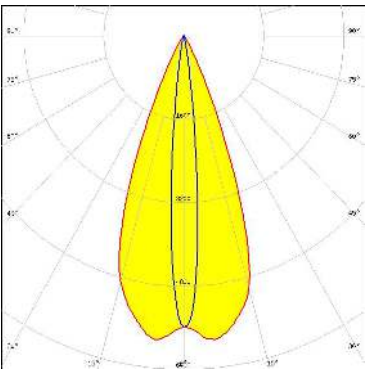
See also our general installation guide: [www.ledil.com/installation\\_guide](http://www.ledil.com/installation_guide)

#### OPTICAL RESULTS (MEASURED):

<p><b>CREE</b> LED</p> <p>LED XM-L RGBW (XMLDCL HI)</p> <p>FWHM / FWTM 42.0 + 11.0° / 58.0 + 22.0°</p> <p>Efficiency 86 %</p> <p>Peak intensity 5.1 cd/lm</p> <p>LEDs/each optic 1</p> <p>Light colour RGBW</p> <p>Required components:</p>		
<p><b>OSRAM</b> Opto Semiconductors</p> <p>LED OSTAR Projection Compact (Kx.CSLNM1.xx)</p> <p>FWHM / FWTM 42.0 + 9.0° / 54.0 + 16.0°</p> <p>Efficiency 90 %</p> <p>Peak intensity 7.8 cd/lm</p> <p>LEDs/each optic 1</p> <p>Light colour White</p> <p>Required components:</p>		
<p><b>OSRAM</b> Opto Semiconductors</p> <p>LED OSTAR Stage (S2WP)</p> <p>FWHM / FWTM 40.0 + 12.0° / 60.0 + 23.0°</p> <p>Efficiency 87 %</p> <p>Peak intensity 4.9 cd/lm</p> <p>LEDs/each optic 1</p> <p>Light colour White</p> <p>Required components:</p>		
<p><b>SEOL</b> SEOUL SEMICONDUCTOR</p> <p>LED SPF05F0A</p> <p>FWHM / FWTM 42.0 + 11.0° / 57.0 + 20.0°</p> <p>Efficiency 88 %</p> <p>Peak intensity 5.9 cd/lm</p> <p>LEDs/each optic 1</p> <p>Light colour RGBW</p> <p>Required components:</p>		

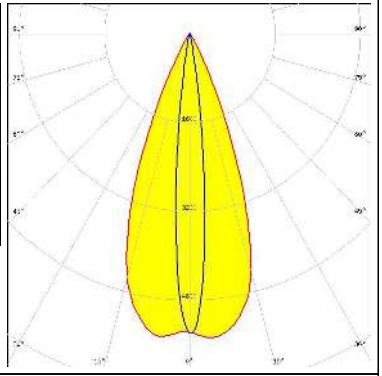
#### OPTICAL RESULTS (MEASURED):

<p> SEOUL SEMICONDUCTOR</p> <p>LED                    SPF05F0B</p> <p>FWHM / FWTM      41.0 + 12.0° / 58.0 + 21.0°</p> <p>Efficiency            88 %</p> <p>Peak intensity      5.5 cd/lm</p> <p>LEDs/each optic    1</p> <p>Light colour        RGBW</p> <p>Required components:</p>		
<p> SEOUL SEMICONDUCTOR</p> <p>LED                    SPF05F0C</p> <p>FWHM / FWTM      41.0 + 13.0° / 60.0 + 23.0°</p> <p>Efficiency            87 %</p> <p>Peak intensity      4.7 cd/lm</p> <p>LEDs/each optic    1</p> <p>Light colour        RGBW</p> <p>Required components:</p>		

#### OPTICAL RESULTS (SIMULATED):

##### CREE LED

LED XHP35 HI  
 FWHM / FWTM 43.0 + 10.0° / 60.0 + 18.0°  
 Efficiency 87 %  
 Peak intensity 5.6 cd/lm  
 LEDs/each optic 1  
 Light colour White  
 Required components:

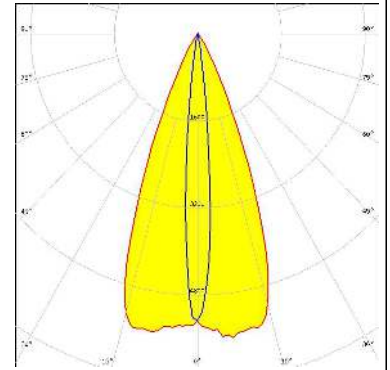

##### CREE LED

LED XHP35.2 HD  
 FWHM / FWTM 42.0 + 10.0° / 61.0 + 21.0°  
 Efficiency 83 %  
 Peak intensity 4.5 cd/lm  
 LEDs/each optic 1  
 Light colour White  
 Required components:

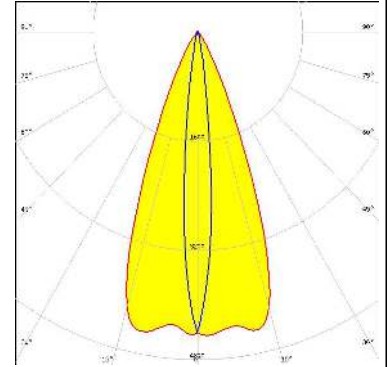

##### CREE LED

LED XHP50  
 FWHM / FWTM 42.0 + 14.0° / 64.0 + 26.0°  
 Efficiency 84 %  
 Peak intensity 3.7 cd/lm  
 LEDs/each optic 1  
 Light colour White  
 Required components:

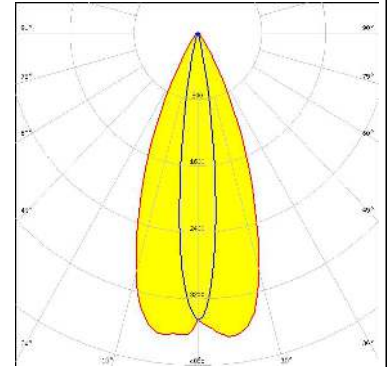

##### CREE LED

LED XHP50.2  
 FWHM / FWTM 42.0 + 14.0° / 66.0 + 28.0°  
 Efficiency 82 %  
 Peak intensity 3.4 cd/lm  
 LEDs/each optic 1  
 Light colour White  
 Required components:

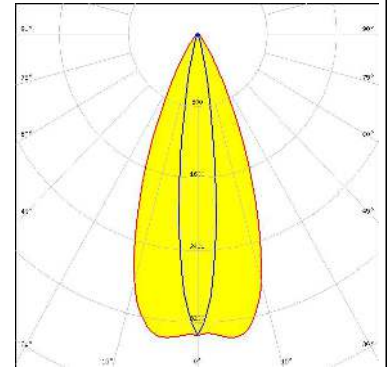

#### OPTICAL RESULTS (SIMULATED):

##### CREE LED

LED XM-L RGBW (XMLCTW)  
 FWHM / FWTM 13.0 + 34.0° / 24.0 + 57.0°  
 Efficiency 86 %  
 Peak intensity 5.1 cd/lm  
 LEDs/each optic 1  
 Light colour White  
 Required components:

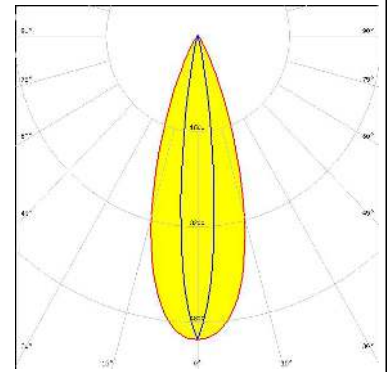

##### CREE LED

LED XM-L2  
 FWHM / FWTM 11.0 + 33.0° / 21.0 + 54.0°  
 Efficiency 87 %  
 Peak intensity 6.2 cd/lm  
 LEDs/each optic 1  
 Light colour White  
 Required components:

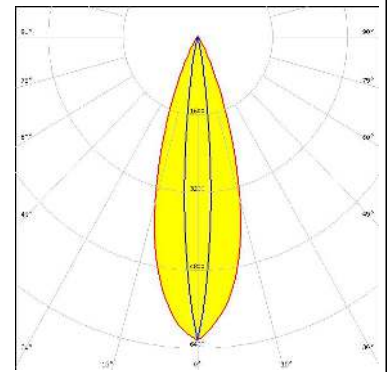

##### CREE LED

LED XP-G2  
 FWHM / FWTM 9.0 + 33.0° / 19.0 + 53.0°  
 Efficiency 87 %  
 Peak intensity 7.2 cd/lm  
 LEDs/each optic 1  
 Light colour White  
 Required components:

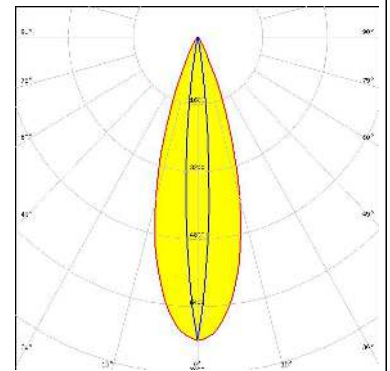

##### CREE LED

LED XP-G2 HE  
 FWHM / FWTM 42.0 + 10.0° / 60.0 + 19.0°  
 Efficiency 86 %  
 Peak intensity 5.3 cd/lm  
 LEDs/each optic 1  
 Light colour White  
 Required components:

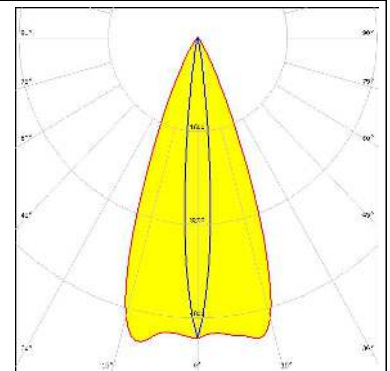

#### OPTICAL RESULTS (SIMULATED):



LED XP-L HI  
 FWHM / FWTM 42.0 + 10.0° / 59.0 + 18.0°  
 Efficiency 87 %  
 Peak intensity 5.9 cd/lm  
 LEDs/each optic 1  
 Light colour White  
 Required components:

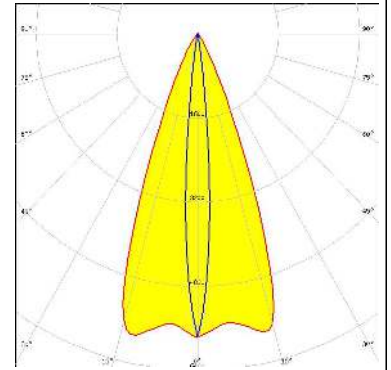

LED LUXEON 5050 Round LES  
 FWHM / FWTM 12.0 + 44.0° / 22.0 + 64.0°  
 Efficiency 86 %  
 Peak intensity 4.3 cd/lm  
 LEDs/each optic 1  
 Light colour White  
 Required components:

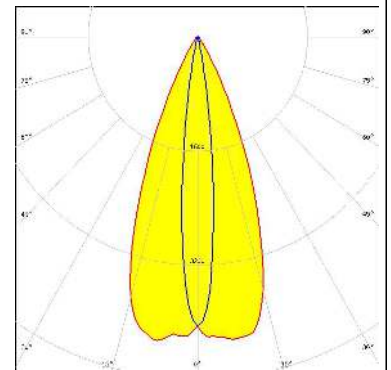

LED LUXEON M/MX  
 FWHM / FWTM 15.0 + 33.0° / 28.0 + 58.0°  
 Efficiency 84 %  
 Peak intensity 4.2 cd/lm  
 LEDs/each optic 1  
 Light colour White  
 Required components:

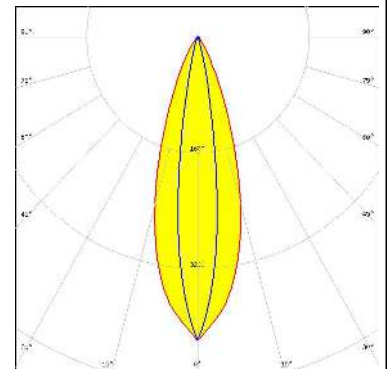

LED LUXEON MZ  
 FWHM / FWTM 11.0 + 32.0° / 22.0 + 55.0°  
 Efficiency 86 %  
 Peak intensity 6 cd/lm  
 LEDs/each optic 1  
 Light colour White  
 Required components:

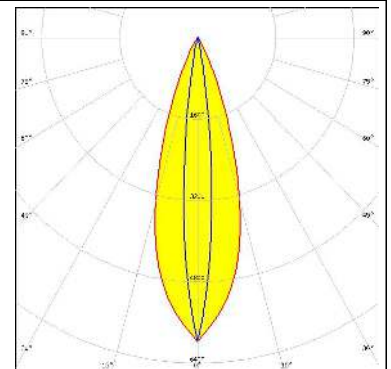

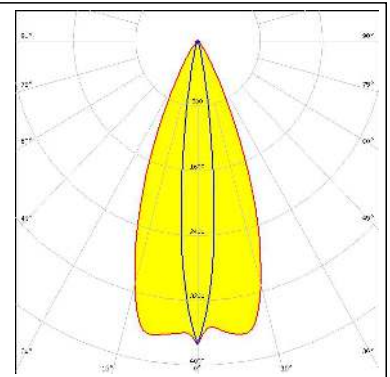
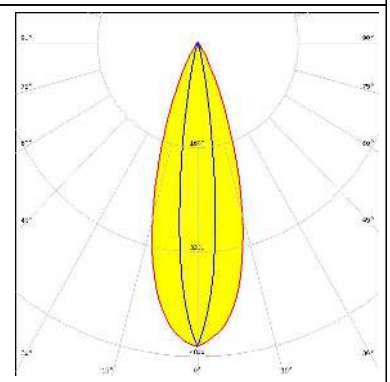
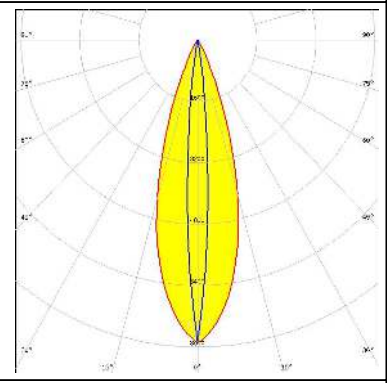
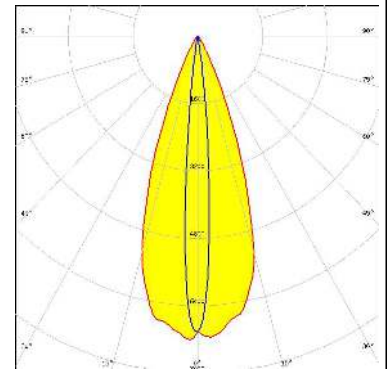

#### OPTICAL RESULTS (SIMULATED):

<p><b>NICHIA</b></p> <p>LED NCSxE17A            FWHM / FWTM 42.0 + 12.0° / 64.0 + 24.0°            Efficiency 81 %            Peak intensity 3.8 cd/lm            LEDs/each optic 4            Light colour RGBW            Required components:</p>	
<p><b>OSRAM</b> Opto Semiconductors</p> <p>LED Duris S8            FWHM / FWTM 14.0 + 34.0° / 26.0 + 57.0°            Efficiency 86 %            Peak intensity 4.7 cd/lm            LEDs/each optic 1            Light colour White            Required components:</p>	
<p><b>OSRAM</b> Opto Semiconductors</p> <p>LED OSOLON Square EC            FWHM / FWTM 8.0 + 31.0° / 17.0 + 52.0°            Efficiency 87 %            Peak intensity 7.9 cd/lm            LEDs/each optic 1            Light colour White            Required components:</p>	
<p><b>OSRAM</b> Opto Semiconductors</p> <p>LED OSTAR Stage (S2WN)            FWHM / FWTM 9.0 + 38.0° / 17.0 + 57.0°            Efficiency 87 %            Peak intensity 7.2 cd/lm            LEDs/each optic 1            Light colour White            Required components:</p>	

### GENERAL INFORMATION:

NOTE: The typical beam angle will be changed by different color, chip size and chip position tolerance. The typical total beam angle is the full angle measured where the luminous intensity is half of the peak value.

### MATERIALS:

As part of our continuous research and improvement processes, and to ensure the best possible quality and availability of our products, LEDiL reserves the right to change material grades without notice.

### PRODUCT DATA USER AGREEMENT AND DISCLAIMER:

The measured data in the provided downloadable LEDiL Product Datasheets and Mechanical 2D-Drawings is rounded and provided as reference for planning. LEDiL Oy's optical specifications have been verified by conducting performance testing of the products in accordance with the company's quality system. The reported data are averaged results of multiple measurements with typical variation. LEDiL Oy reserves the right to without prior notification make changes and improvements to its products.

LEDiL Oy assumes neither warranty, nor guarantee nor any other liability of any kind for the contents and correctness of the provided data. The provided data has been generated with highest diligence but the provided data may in reality not represent the complete possible variation range of all intrinsic parameters. Therefore, in certain cases a deviation from the provided data could occur.

LEDiL Oy reserves the right to undertake technical changes of its products without further notification which could lead to changes in the provided data. LEDiL Oy assumes no liability of any kind for the possible deviation from any provided data or any other damage resulting from the usage of the provided data.

The user agrees to this disclaimer and user agreement with the download or usage of the provided files.

#### LEDiL Oy

Joensuunkatu 13  
FI-24240 SALO  
Finland

#### LEDiL Inc.

228 West Page Street  
Suite D  
Sycamore IL 60178  
USA

#### Ledil Optics Technology (Shenzhen) Co., Ltd.

# 405 , Block B  
Casic Motor Building  
Shenzhen 518057  
P.R.CHINA

#### Local sales and technical support

[www.ledil.com/  
where\\_to\\_buy](http://www.ledil.com/where_to_buy)

#### Shipping locations

Salo, Finland  
Hong Kong, China

#### Distribution Partners

[www.ledil.com/  
where\\_to\\_buy](http://www.ledil.com/where_to_buy)