



Part Number: D3C8012

Electrical Specifications

Frequency Range (GHz):	8.0 - 12.4
Isolation (dB):	20 MIN
Insertion Loss (dB):	0.5 MAX
VSWR:	1.25:1 MIN
Forward Power (W):	25 AVG 500 PK

Mechanical/Environmental Specifications

Connector Type:	SMA
Connector Body:	Passivated stainless steel
Connector Pin:	Gold plated copper
Load Body:	Brass
Magnetic Shunt:	Nickel plated CRS
Operational Temp:	-30°C to +85°C
Weight (oz)	1.0 MAX

D3C8012 Dimensions

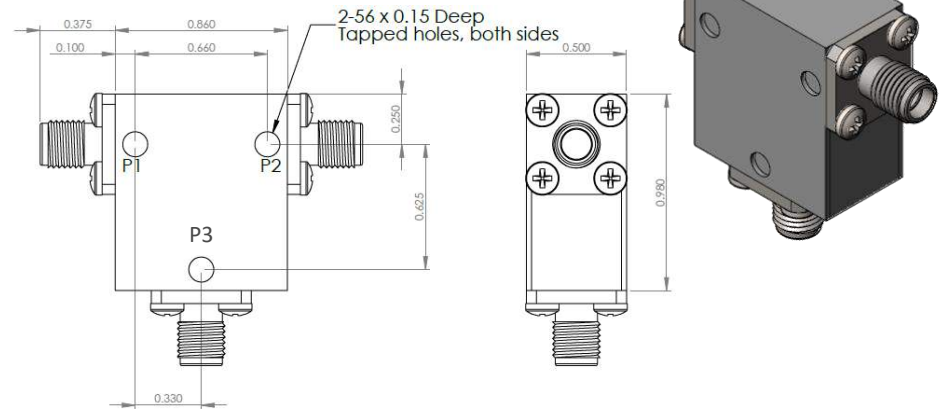

D3C8012-3 Dimensions

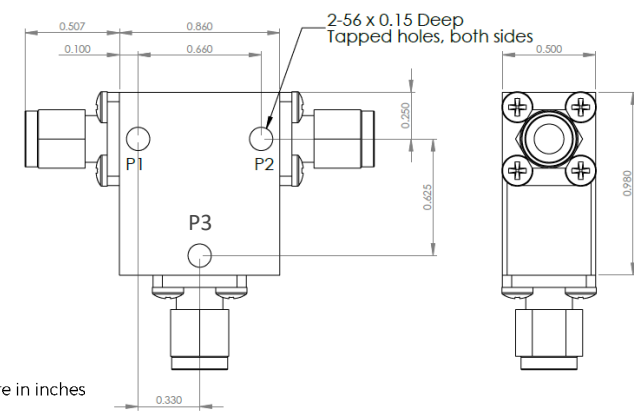

Dimensions are in inches
Tolerance

XX	±0.03
XXX	±0.010

Type of Device	PN Suffix	Connector Configuration Input / Output	PN Example
Single Junction Circulator 3-Port Device Port 1 / Port 2 / Port 3	No Dash	Female / Female / Female	D3C8012
	-1	Male / Female / Female	D3C8012-1
	-2	Female / Male / Female	D3C8012-2
	-3	Male / Male / Male	D3C8012-3
	-4	Female / Female / Male	D3C8012-4
	-5	Male / Female / Male	D3C8012-5
	-6	Male / Male / Female	D3C8012-6
	-7	Female / Male / Male	D3C8012-7



MEASURED DATA

Part Number: D3C8012, P1→P2, P3 Terminated with 50Ω, +25°C

