

POWR-SPEED® Fuse

PSR SERIES HIGH-SPEED SQUARE BODY

Semiconductor Fuses • Flush End • 40 A–2250 A



Description

Littelfuse PSR series high-speed square body fuses are specially designed for protection of power semiconductor devices such as diodes, triacs, IGBTs, SCRs, MOSFETs, and other solid state devices that are typically designed into power conversion and power conditioning equipment. Variable frequency drives, inverters, UPS, rectifiers, and soft-starters are examples of typical equipment designed with sensitive power semiconductor devices that cannot withstand any line surge or overcurrent conditions and require high-speed protection.

Littelfuse POWR-SPEED PSR series products offer optimized circuit protection at the extremely fast speed required to protect modern day power conversion devices. Such products are commonly found in numerous applications including pulp and paper industries, cranes and heavy-lifting equipment, processing industries, wastewater treatment plants, and various large factories and MRO facilities.

Features/Benefits

- Best in class dc performance
- Extremely current limiting
- Superior cycling capability
- Global certification cURus, CCC*
- Direct bus-bar mount design
- Visual and optional microswitch fuse blown indication
- Low watt-loss design
- Compliance with US and Canadian requirements
- Fast-acting Class aR performance

Applications

- Power conversion devices (UPS, inverter, rectifiers, drives)
- Dc systems (dc common bus, dc injection braking)
- Battery protection application (energy storage systems)
- Electric vehicle charging stations
- Heaters and power supplies

Specifications

Voltage Range	Ac: 450 V–1300 V Dc: 450 V–1000 V
Amperage Range	40 A–2250 A
Interrupting Range	Ac: 100 kA–200 kA Dc: 150 kA
Time Constant	10 ms at IR
Microswitch	Yes
Mounting	Flush-end style
Material	Body: ceramic Contacts: plated brass
Approvals	cURus Recognized (File: E71611) CCC (Ac voltage) *
Applicable Standards	UL248-13, IEC 60269-4 (Class aR)
Environmental	RoHS Compliant, REACH
Operating Temperature	-55 °C to +125 °C
Storage Temperature	Up to +35 °C with relative humidity <65 %
Country of Origin	Mexico

Ordering Part Number

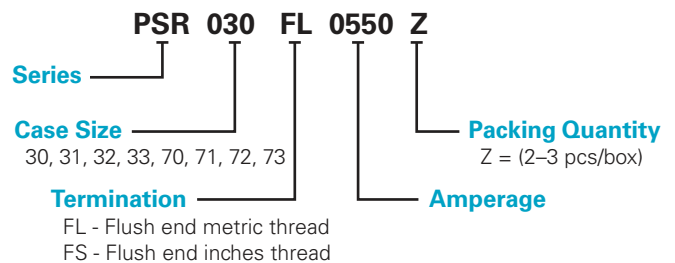

Catalog Number

SERIES	CASE SIZE	TERMINATION	AMPERAGE	CATALOG NUMBER	ORDERING PART NUMBER
PSR	030	FL	0550	PSR030FL0550	PSR030FL0550Z

Recommended Accessories

Microswitch: MS3H1000C (case size 30 to 33)
MS7H1500C (case size 70 to 73)

Web Resources

Download technical documents: [Littelfuse.com/PSR](https://www.littelfuse.com/PSR)
Note: high-speed fuses are designed for fixed installations. They are not intended for use in moving vehicle applications.

* Refer to CCC section of Electrical Characteristics table

POWR-SPEED® Fuse

PSR SERIES HIGH-SPEED SQUARE BODY

Electrical Characteristics

CASE SIZE	CATALOG NUMBER		AMPERE RATING (A)	VOLTAGE RATING (V)			INTERRUPTING RATING		MELTING (PRE-ARC) I ² T (A ² s)	TOTAL CLEARING I ² T (A ² s) AT RATED VOLTAGE		WATT LOSS AT 100 % RATED CURRENT (W)	AGENCY CERTIFICATION	
	FLUSH END METRIC THREAD	FLUSH END INCHES THREAD		AC		DC	AC	DC		AC	DC		cURus	CCC*
				IEC	UL									
30	PSR030FL0040	PSR030FS0040	40	690	700	600	200 kA	150 kA	76	280	260	12	•	•
	PSR030FL0050	PSR030FS0050	50	690	700	600	200 kA	150 kA	110	598	384	15	•	•
	PSR030FL0063	PSR030FS0063	63	690	700	600	200 kA	150 kA	176	1023	640	20	•	•
	PSR030FL0080	PSR030FS0080	80	690	700	600	200 kA	150 kA	304	1728	1252	24	•	•
	PSR030FL0100	PSR030FS0100	100	690	700	600	200 kA	150 kA	437	2835	1575	27	•	•
	PSR030FL0125	PSR030FS0125	125	690	700	600	200 kA	150 kA	707	4684	2783	36	•	•
	PSR030FL0160	PSR030FS0160	160	690	700	600	200 kA	150 kA	1359	9114	5507	39	•	•
	PSR030FL0200	PSR030FS0200	200	690	700	600	200 kA	150 kA	3012	15169	14700	39	•	•
	PSR030FL0250	PSR030FS0250	250	690	700	600	200 kA	150 kA	4668	29952	20833	50	•	•
	PSR030FL0315	PSR030FS0315	315	690	700	600	200 kA	150 kA	7131	61830	31600	61	•	•
	PSR030FL0350	PSR030FS0350	350	690	700	600	200 kA	150 kA	12007	85320	49273	62	•	•
	PSR030FL0400	PSR030FS0400	400	690	700	600	200 kA	150 kA	16209	114750	63367	75	•	•
	PSR030FL0450	PSR030FS0450	450	690	700	600	200 kA	150 kA	23133	160110	93533	75	•	•
	PSR030FL0500	PSR030FS0500	500	690	700	600	200 kA	150 kA	31429	225180	137333	80	•	•
PSR030FL0550	PSR030FS0550	550	690	700	600	200 kA	150 kA	44323	268920	145400	78	•	•	
PSR030FL0630	PSR030FS0630	630	690	700	550	200 kA	150 kA	57404	480010	267800	90	•	•	
31	PSR031FL0200	PSR031FS0200	200	690	700	600	200 kA	150 kA	1965	17334	16188	49	•	•
	PSR031FL0250	PSR031FS0250	250	690	700	600	200 kA	150 kA	3789	35343	21080	52	•	•
	PSR031FL0315	PSR031FS0315	315	690	700	600	200 kA	150 kA	6862	59130	30694	61	•	•
	PSR031FL0350	PSR031FS0350	350	690	700	600	200 kA	150 kA	9523	76140	40996	63	•	•
	PSR031FL0400	PSR031FS0400	400	690	700	600	200 kA	150 kA	14770	124335	64359	64	•	•
	PSR031FL0450	PSR031FS0450	450	690	700	600	200 kA	150 kA	22457	178200	97444	69	•	•
	PSR031FL0500	PSR031FS0500	500	690	700	600	200 kA	150 kA	29751	251505	125935	81	•	•
	PSR031FL0550	PSR031FS0550	550	690	700	600	200 kA	150 kA	42056	289170	171845	77	•	•
	PSR031FL0630	PSR031FS0630	630	690	700	600	200 kA	150 kA	45403	415500	175500	93	•	•
	PSR031FL0700	PSR031FS0700	700	690	700	600	200 kA	150 kA	98187	601425	337260	92	•	•
PSR031FL0800	PSR031FS0800	800	690	700	600	200 kA	150 kA	137208	848880	502800	106	•	•	
PSR031FL0900	PSR031FS0900	900	550	600	550	200 kA	150 kA	155163	945100	631820	118	•	•	
32	PSR032FL0400	PSR032FS0400	400	690	700	600	200 kA	150 kA	11104	79650	44533	82	•	•
	PSR032FL0450	PSR032FS0450	450	690	700	600	200 kA	150 kA	15535	116100	65463	88	•	•
	PSR032FL0500	PSR032FS0500	500	690	700	600	200 kA	150 kA	21573	161460	88277	94	•	•
	PSR032FL0550	PSR032FS0550	550	690	700	600	200 kA	150 kA	26327	177660	107960	104	•	•
	PSR032FL0630	PSR032FS0630	630	690	700	600	200 kA	150 kA	34790	234900	156963	110	•	•
	PSR032FL0700	PSR032FS0700	700	690	700	600	200 kA	150 kA	51191	291870	209287	117	•	•
	PSR032FL0800	PSR032FS0800	800	690	700	600	200 kA	150 kA	60125	472770	249000	145	•	•
	PSR032FL0900	PSR032FS0900	900	690	700	600	200 kA	150 kA	107785	764100	404000	145	•	•
	PSR032FL1000	PSR032FS1000	1000	690	700	600	200 kA	150 kA	190102	933120	672333	146	•	•
	PSR032FL1100	PSR032FS1100	1100	690	700	600	200 kA	150 kA	225379	1247400	744000	149	•	•
	PSR032FL1250	PSR032FS1250	1250	550	500**	450**	200 kA	150 kA	336661	1114994	1197000	149	•	•
	PSR032FL1400	PSR032FS1400	1400	450	500	450	200 kA	150 kA	551749	1611639	1865400	154	•	•
	PSR032FL1500	PSR032FS1500	1500	450	500	450	200 kA	150 kA	673360	2045907	1735500	171	•	•
33	PSR033FL0450	PSR033FS0450	450	690	700	600	200 kA	150 kA	13600	106380	58947	99	•	•
	PSR033FL0500	PSR033FS0500	500	690	700	600	200 kA	150 kA	16434	140400	77846	107	•	•
	PSR033FL0550	PSR033FS0550	550	690	700	600	200 kA	150 kA	23314	187650	100461	108	•	•
	PSR033FL0630	PSR033FS0630	630	690	700	600	200 kA	150 kA	38727	285930	142437	113	•	•
	PSR033FL0700	PSR033FS0700	700	690	700	600	200 kA	150 kA	56763	392580	209863	113	•	•
	PSR033FL0800	PSR033FS0800	800	690	700	600	200 kA	150 kA	84691	575505	348500	120	•	•
	PSR033FL0900	PSR033FS0900	900	690	700	600	200 kA	150 kA	122619	740340	451177	122	•	•
	PSR033FL1000	PSR033FS1000	1000	690	700	600	200 kA	150 kA	222350	1170450	787750	124	•	•
	PSR033FL1100	PSR033FS1100	1100	690	700	600	200 kA	150 kA	310824	1568700	821400	127	•	•
	PSR033FL1250	PSR033FS1250	1250	690	700	600	200 kA	150 kA	476902	2403000	1674333	131	•	•
	PSR033FL1400	PSR033FS1400	1400	690	700	500	200 kA	150 kA	583552	2920050	1979750	144	•	•
	PSR033FL1500	PSR033FS1500	1500	600	650	500	200 kA	150 kA	674538	2433200	1996733	163	•	•
	PSR033FL1600	PSR033FS1600	1600	600	650	500	200 kA	150 kA	779948	2942800	2301633	182	•	•
	PSR033FL1800	PSR033FS1800	1800	600	650	500	200 kA	150 kA	952196	3785040	2724180	224	•	•
	PSR033FL2000	PSR033FS2000	2000	550	600	500	200 kA	150 kA	1234315	4131600	3755180	222	•	•
PSR033FL2250	PSR033FS2250	2250	500	550	450	200 kA	150 kA	1236000	4459651	3859500	299	•	•	

* CCC Certification only on Flush End Metric Thread Version

** PSR032 1250 A: 600 V Ac/550 V Dc

POWR-SPEED® Fuse

PSR SERIES HIGH-SPEED SQUARE BODY

Electrical Characteristics (cont.)

CASE SIZE	CATALOG NUMBER		AMPERE RATING (A)	VOLTAGE RATING (V)			INTERRUPTING RATING		MELTING (PRE-ARC) I ² T (A ² s)	TOTAL CLEARING I ² T (A ² s) AT RATED VOLTAGE		WATT LOSS AT 100 % RATED CURRENT (W)	AGENCY CERTIFICATION	
	FLUSH END METRIC THREAD	FLUSH END INCHES THREAD		AC		DC	AC	DC		AC	DC		cURus	CCC*
				IEC	UL									
70	PSR070FL0050	PSR070FS0050	50	1250	1300	1000	100 kA	150 kA	177	2050	400	21	•	•
	PSR070FL0063	PSR070FS0063	63	1250	1300	1000	100 kA	150 kA	273	3399	900	23	•	•
	PSR070FL0080	PSR070FS0080	80	1250	1300	1000	100 kA	150 kA	583	6732	2200	24	•	•
	PSR070FL0100	PSR070FS0100	100	1250	1300	1000	100 kA	150 kA	974	10996	3750	29	•	•
	PSR070FL0125	PSR070FS0125	125	1250	1300	1000	100 kA	150 kA	1352	13011	5150	43	•	•
	PSR070FL0160	PSR070FS0160	160	1250	1300	1000	100 kA	150 kA	2377	25662	8950	51	•	•
	PSR070FL0200	PSR070FS0200	200	1250	1300	1000	100 kA	150 kA	4177	39087	17267	61	•	•
	PSR070FL0250	PSR070FS0250	250	1250	1300	1000	100 kA	150 kA	8629	89790	36750	71	•	•
	PSR070FL0280	PSR070FS0280	280	1250	1300	1000	100 kA	150 kA	11844	113201	46750	71	•	•
	PSR070FL0315	PSR070FS0315	315	1250	1300	1000	100 kA	150 kA	18162	142051	66833	69	•	•
PSR070FL0350	PSR070FS0350	350	1250	1200**	900**	100 kA	150 kA	22963	215230	95410	73	•	•	
PSR070FL0400	PSR070FS0400	400	1100	1200	900	100 kA	150 kA	37103	283480	154320	71	•	•	
71	PSR071FL0160	PSR071FS0160	160	1250	1300	1000	100 kA	150 kA	2756	24600	8800	42	•	•
	PSR071FL0200	PSR071FS0200	200	1250	1300	1000	100 kA	150 kA	4918	50307	19050	52	•	•
	PSR071FL0250	PSR071FS0250	250	1250	1300	1000	100 kA	150 kA	10592	104427	43100	54	•	•
	PSR071FL0280	PSR071FS0280	280	1250	1300	1000	100 kA	150 kA	13763	131897	54150	58	•	•
	PSR071FL0315	PSR071FS0315	315	1250	1300	1000	100 kA	150 kA	20882	200244	67450	60	•	•
	PSR071FL0350	PSR071FS0350	350	1250	1300	1000	100 kA	150 kA	23301	225500	102500	71	•	•
	PSR071FL0400	PSR071FS0400	400	1250	1300	1000	100 kA	150 kA	43211	374986	185000	69	•	•
	PSR071FL0450	PSR071FS0450	450	1250	1300	1000	100 kA	150 kA	55915	452394	241333	88	•	•
	PSR071FL0500	PSR071FS0500	500	1100	1200	900	100 kA	150 kA	75315	468845	253960	82	•	•
	PSR071FL0550	PSR071FS0550	550	1100	1200	900	100 kA	150 kA	87328	693507	332600	90	•	•
PSR071FL0630	PSR071FS0630	630	1000	1100	900	100 kA	150 kA	131240	790862	426550	100	•	•	
72	PSR072FL0250	PSR072FS0250	250	1250	1300	1000	100 kA	150 kA	7737	72789	28567	63	•	•
	PSR072FL0280	PSR072FS0280	280	1250	1300	1000	100 kA	150 kA	10915	124538	46897	62	•	•
	PSR072FL0315	PSR072FS0315	315	1250	1300	1000	100 kA	150 kA	16187	145140	58867	67	•	•
	PSR072FL0350	PSR072FS0350	350	1250	1300	1000	100 kA	150 kA	18727	160447	69633	80	•	•
	PSR072FL0400	PSR072FS0400	400	1250	1300	1000	100 kA	150 kA	27112	243540	108000	89	•	•
	PSR072FL0450	PSR072FS0450	450	1250	1300	1000	100 kA	150 kA	35927	406413	159133	107	•	•
	PSR072FL0500	PSR072FS0500	500	1250	1300	1000	100 kA	150 kA	50398	425375	216333	115	•	•
	PSR072FL0550	PSR072FS0550	550	1250	1300	1000	100 kA	150 kA	73858	539833	271333	115	•	•
	PSR072FL0630	PSR072FS0630	630	1250	1300	1000	100 kA	150 kA	126126	942180	436000	119	•	•
	PSR072FL0700	PSR072FS0700	700	1100	1200	900***	100 kA	150 kA	228761	1123694	715180	115	•	•
	PSR072FL0800	PSR072FS0800	800	1100	1200	900***	100 kA	150 kA	230695	1432388	911650	113	•	•
	PSR072FL0900	PSR072FS0900	900	1000	900**	900***	100 kA	150 kA	376641	1309993	1030400	125	•	•
PSR072FL1000	PSR072FS1000	1000	850	900	800***	100 kA	150 kA	455955	1772548	1361500	136	•	•	
73	PSR073FL0315	PSR073FS0315	315	1250	1300	1000	100 kA	150 kA	10245	106600	38650	88	•	•
	PSR073FL0350	PSR073FS0350	350	1250	1300	1000	100 kA	150 kA	13586	159627	57467	96	•	•
	PSR073FL0400	PSR073FS0400	400	1250	1300	1000	100 kA	150 kA	19797	211273	86800	124	•	•
	PSR073FL0450	PSR073FS0450	450	1250	1300	1000	100 kA	150 kA	29834	279073	114333	122	•	•
	PSR073FL0500	PSR073FS0500	500	1250	1300	1000	100 kA	150 kA	42751	416437	184500	121	•	•
	PSR073FL0550	PSR073FS0550	550	1250	1300	1000	100 kA	150 kA	55513	491713	224500	130	•	•
	PSR073FL0630	PSR073FS0630	630	1250	1300	1000	100 kA	150 kA	94649	804338	377500	136	•	•
	PSR073FL0700	PSR073FS0700	700	1250	1300	1000	100 kA	150 kA	158097	1170960	575667	135	•	•
	PSR073FL0800	PSR073FS0800	800	1250	1300	1000***	100 kA	150 kA	234943	1769880	733460	123	•	•
	PSR073FL0900	PSR073FS0900	900	950	1050	800***	100 kA	150 kA	317743	2280547	901779	140	•	•
	PSR073FL1000	PSR073FS1000	1000	950	1050	800***	100 kA	150 kA	476221	3910801	1546418	128	•	•
	PSR073FL1100	PSR073FS1100	1100	950	1050	800***	100 kA	150 kA	570870	2736600	1699000	166	•	•
	PSR073FL1250	PSR073FS1250	1250	900	1000	-	100 kA	-	993924	3091160	-	182	•	•
	PSR073FL1400	PSR073FS1400	1400	900	1000	-	100 kA	-	1168091	3627820	-	229	•	•

* CCC Certification only on Flush End Metric Thread Version

** PSR070 350 A: 1300 V Ac/1000 V Dc

PSR072 900 A: 1100 V Ac

*** No UL certification for Dc voltage

POWR-SPEED® Fuse

PSR SERIES HIGH-SPEED SQUARE BODY

Ordering Information

CASE SIZE	FLUSH END - METRIC THREAD			FLUSH END - INCHES THREAD			BOX QUANTITY PCS/BOX
	CATALOG NUMBER	ORDERING PART NUMBER	UPC	CATALOG NUMBER	ORDERING PART NUMBER	UPC	
30	PSR030FL0040	PSR030FL0040Z	07945820436	PSR030FS0040	PSR030FS0040Z	07945820451	3 pcs/box
	PSR030FL0050	PSR030FL0050Z	07945820437	PSR030FS0050	PSR030FS0050Z	07945820452	3 pcs/box
	PSR030FL0063	PSR030FL0063Z	07945820438	PSR030FS0063	PSR030FS0063Z	07945820453	3 pcs/box
	PSR030FL0080	PSR030FL0080Z	07945820439	PSR030FS0080	PSR030FS0080Z	07945820454	3 pcs/box
	PSR030FL0100	PSR030FL0100Z	07945820440	PSR030FS0100	PSR030FS0100Z	07945820455	3 pcs/box
	PSR030FL0125	PSR030FL0125Z	07945820441	PSR030FS0125	PSR030FS0125Z	07945820456	3 pcs/box
	PSR030FL0160	PSR030FL0160Z	07945820442	PSR030FS0160	PSR030FS0160Z	07945820457	3 pcs/box
	PSR030FL0200	PSR030FL0200Z	07945820443	PSR030FS0200	PSR030FS0200Z	07945820458	3 pcs/box
	PSR030FL0250	PSR030FL0250Z	07945820444	PSR030FS0250	PSR030FS0250Z	07945820459	3 pcs/box
	PSR030FL0315	PSR030FL0315Z	07945820445	PSR030FS0315	PSR030FS0315Z	07945820460	3 pcs/box
	PSR030FL0350	PSR030FL0350Z	07945820446	PSR030FS0350	PSR030FS0350Z	07945820461	3 pcs/box
	PSR030FL0400	PSR030FL0400Z	07945820447	PSR030FS0400	PSR030FS0400Z	07945820462	3 pcs/box
	PSR030FL0450	PSR030FL0450Z	07945820448	PSR030FS0450	PSR030FS0450Z	07945820463	3 pcs/box
	PSR030FL0500	PSR030FL0500Z	07945820449	PSR030FS0500	PSR030FS0500Z	07945820464	3 pcs/box
	PSR030FL0550	PSR030FL0550Z	07945820450	PSR030FS0550	PSR030FS0550Z	07945820465	3 pcs/box
PSR030FL0630	PSR030FL0630Z	07945827757	PSR030FS0630	PSR030FS0630Z	07945827778	3 pcs/box	
31	PSR031FL0200	PSR031FL0200Z	07945820466	PSR031FS0200	PSR031FS0200Z	07945820477	3 pcs/box
	PSR031FL0250	PSR031FL0250Z	07945820467	PSR031FS0250	PSR031FS0250Z	07945820478	3 pcs/box
	PSR031FL0315	PSR031FL0315Z	07945820468	PSR031FS0315	PSR031FS0315Z	07945820479	3 pcs/box
	PSR031FL0350	PSR031FL0350Z	07945820469	PSR031FS0350	PSR031FS0350Z	07945820480	3 pcs/box
	PSR031FL0400	PSR031FL0400Z	07945820470	PSR031FS0400	PSR031FS0400Z	07945820481	3 pcs/box
	PSR031FL0450	PSR031FL0450Z	07945820471	PSR031FS0450	PSR031FS0450Z	07945820482	3 pcs/box
	PSR031FL0500	PSR031FL0500Z	07945820472	PSR031FS0500	PSR031FS0500Z	07945820483	3 pcs/box
	PSR031FL0550	PSR031FL0550Z	07945820473	PSR031FS0550	PSR031FS0550Z	07945820484	3 pcs/box
	PSR031FL0630	PSR031FL0630Z	07945820474	PSR031FS0630	PSR031FS0630Z	07945820485	3 pcs/box
	PSR031FL0700	PSR031FL0700Z	07945820475	PSR031FS0700	PSR031FS0700Z	07945820486	3 pcs/box
	PSR031FL0800	PSR031FL0800Z	07945820476	PSR031FS0800	PSR031FS0800Z	07945820487	3 pcs/box
	PSR031FL0900	PSR031FL0900Z	07945827758	PSR031FS0900	PSR031FS0900Z	07945827779	3 pcs/box
32	PSR032FL0400	PSR032FL0400Z	07945820488	PSR032FS0400	PSR032FS0400Z	07945820498	3 pcs/box
	PSR032FL0450	PSR032FL0450Z	07945820489	PSR032FS0450	PSR032FS0450Z	07945820499	3 pcs/box
	PSR032FL0500	PSR032FL0500Z	07945820490	PSR032FS0500	PSR032FS0500Z	07945820500	3 pcs/box
	PSR032FL0550	PSR032FL0550Z	07945820491	PSR032FS0550	PSR032FS0550Z	07945820501	3 pcs/box
	PSR032FL0630	PSR032FL0630Z	07945820492	PSR032FS0630	PSR032FS0630Z	07945820502	3 pcs/box
	PSR032FL0700	PSR032FL0700Z	07945820493	PSR032FS0700	PSR032FS0700Z	07945820503	3 pcs/box
	PSR032FL0800	PSR032FL0800Z	07945820494	PSR032FS0800	PSR032FS0800Z	07945820504	3 pcs/box
	PSR032FL0900	PSR032FL0900Z	07945820495	PSR032FS0900	PSR032FS0900Z	07945820505	3 pcs/box
	PSR032FL1000	PSR032FL1000Z	07945820496	PSR032FS1000	PSR032FS1000Z	07945820506	3 pcs/box
	PSR032FL1100	PSR032FL1100Z	07945820497	PSR032FS1100	PSR032FS1100Z	07945820507	3 pcs/box
	PSR032FL1250	PSR032FL1250Z	07945827759	PSR032FS1250	PSR032FS1250Z	07945827780	3 pcs/box
	PSR032FL1400	PSR032FL1400Z	07945827760	PSR032FS1400	PSR032FS1400Z	07945827781	3 pcs/box
	PSR032FL1500	PSR032FL1500Z	07945827761	PSR032FS1500	PSR032FS1500Z	07945827782	3 pcs/box
	33	PSR033FL0450	PSR033FL0450Z	07945822163	PSR033FS0450	PSR033FS0450Z	07945822164
PSR033FL0500		PSR033FL0500Z	07945820508	PSR033FS0500	PSR033FS0500Z	07945820522	3 pcs/box
PSR033FL0550		PSR033FL0550Z	07945820509	PSR033FS0550	PSR033FS0550Z	07945820523	3 pcs/box
PSR033FL0630		PSR033FL0630Z	07945820510	PSR033FS0630	PSR033FS0630Z	07945820524	3 pcs/box
PSR033FL0700		PSR033FL0700Z	07945820511	PSR033FS0700	PSR033FS0700Z	07945820525	3 pcs/box
PSR033FL0800		PSR033FL0800Z	07945820512	PSR033FS0800	PSR033FS0800Z	07945820526	3 pcs/box
PSR033FL0900		PSR033FL0900Z	07945820513	PSR033FS0900	PSR033FS0900Z	07945820527	3 pcs/box
PSR033FL1000		PSR033FL1000Z	07945820514	PSR033FS1000	PSR033FS1000Z	07945820528	3 pcs/box
PSR033FL1100		PSR033FL1100Z	07945820515	PSR033FS1100	PSR033FS1100Z	07945820529	3 pcs/box
PSR033FL1250		PSR033FL1250Z	07945820516	PSR033FS1250	PSR033FS1250Z	07945820530	3 pcs/box
PSR033FL1400		PSR033FL1400Z	07945820517	PSR033FS1400	PSR033FS1400Z	07945820531	3 pcs/box
PSR033FL1500		PSR033FL1500Z	07945820518	PSR033FS1500	PSR033FS1500Z	07945820532	3 pcs/box
PSR033FL1600		PSR033FL1600Z	07945820519	PSR033FS1600	PSR033FS1600Z	07945820533	3 pcs/box
PSR033FL1800		PSR033FL1800Z	07945820520	PSR033FS1800	PSR033FS1800Z	07945820534	3 pcs/box
PSR033FL2000		PSR033FL2000Z	07945820521	PSR033FS2000	PSR033FS2000Z	07945820535	3 pcs/box
PSR033FL2250	PSR033FL2250Z	07945827762	PSR033FS2250	PSR033FS2250Z	07945827783	3 pcs/box	

POWR-SPEED® Fuse

PSR SERIES HIGH-SPEED SQUARE BODY

Ordering Information (cont.)

CASE SIZE	FLUSH END - METRIC THREAD			FLUSH END - INCHES THREAD			BOX QUANTITY PCS/BOX
	CATALOG NUMBER	ORDERING PART NUMBER	UPC	CATALOG NUMBER	ORDERING PART NUMBER	UPC	
70	PSR070FL0050	PSR070FL0050Z	07945820536	PSR070FS0050	PSR070FS0050Z	07945820546	2 pcs/box
	PSR070FL0063	PSR070FL0063Z	07945820537	PSR070FS0063	PSR070FS0063Z	07945820547	2 pcs/box
	PSR070FL0080	PSR070FL0080Z	07945820538	PSR070FS0080	PSR070FS0080Z	07945820548	2 pcs/box
	PSR070FL0100	PSR070FL0100Z	07945820539	PSR070FS0100	PSR070FS0100Z	07945820549	2 pcs/box
	PSR070FL0125	PSR070FL0125Z	07945820540	PSR070FS0125	PSR070FS0125Z	07945820550	2 pcs/box
	PSR070FL0160	PSR070FL0160Z	07945820541	PSR070FS0160	PSR070FS0160Z	07945820551	2 pcs/box
	PSR070FL0200	PSR070FL0200Z	07945820542	PSR070FS0200	PSR070FS0200Z	07945820552	2 pcs/box
	PSR070FL0250	PSR070FL0250Z	07945820543	PSR070FS0250	PSR070FS0250Z	07945820553	2 pcs/box
	PSR070FL0280	PSR070FL0280Z	07945820544	PSR070FS0280	PSR070FS0280Z	07945820554	2 pcs/box
	PSR070FL0315	PSR070FL0315Z	07945820545	PSR070FS0315	PSR070FS0315Z	07945820555	2 pcs/box
	PSR070FL0350	PSR070FL0350Z	07945827763	PSR070FS0350	PSR070FS0350Z	07945827784	2 pcs/box
	PSR070FL0400	PSR070FL0400Z	07945827764	PSR070FS0400	PSR070FS0400Z	07945827785	2 pcs/box
71	PSR071FL0160	PSR071FL0160Z	07945820556	PSR071FS0160	PSR071FS0160Z	07945820564	2 pcs/box
	PSR071FL0200	PSR071FL0200Z	07945820557	PSR071FS0200	PSR071FS0200Z	07945820565	2 pcs/box
	PSR071FL0250	PSR071FL0250Z	07945820558	PSR071FS0250	PSR071FS0250Z	07945820566	2 pcs/box
	PSR071FL0280	PSR071FL0280Z	07945820573	PSR071FS0280	PSR071FS0280Z	07945820582	2 pcs/box
	PSR071FL0315	PSR071FL0315Z	07945820560	PSR071FS0315	PSR071FS0315Z	07945820568	2 pcs/box
	PSR071FL0350	PSR071FL0350Z	07945820561	PSR071FS0350	PSR071FS0350Z	07945820569	2 pcs/box
	PSR071FL0400	PSR071FL0400Z	07945820562	PSR071FS0400	PSR071FS0400Z	07945820570	2 pcs/box
	PSR071FL0450	PSR071FL0450Z	07945820563	PSR071FS0450	PSR071FS0450Z	07945820571	2 pcs/box
	PSR071FL0500	PSR071FL0500Z	07945827765	PSR071FS0500	PSR071FS0500Z	07945827786	2 pcs/box
	PSR071FL0550	PSR071FL0550Z	07945827766	PSR071FS0550	PSR071FS0550Z	07945827787	2 pcs/box
	PSR071FL0630	PSR071FL0630Z	07945827767	PSR071FS0630	PSR071FS0630Z	07945827788	2 pcs/box
72	PSR072FL0250	PSR072FL0250Z	07945820572	PSR072FS0250	PSR072FS0250Z	07945820581	2 pcs/box
	PSR072FL0280	PSR072FL0280Z	07945820573	PSR072FS0280	PSR072FS0280Z	07945820582	2 pcs/box
	PSR072FL0315	PSR072FL0315Z	07945820574	PSR072FS0315	PSR072FS0315Z	07945820583	2 pcs/box
	PSR072FL0350	PSR072FL0350Z	07945820575	PSR072FS0350	PSR072FS0350Z	07945820584	2 pcs/box
	PSR072FL0400	PSR072FL0400Z	07945820576	PSR072FS0400	PSR072FS0400Z	07945820585	2 pcs/box
	PSR072FL0450	PSR072FL0450Z	07945820577	PSR072FS0450	PSR072FS0450Z	07945820586	2 pcs/box
	PSR072FL0500	PSR072FL0500Z	07945820578	PSR072FS0500	PSR072FS0500Z	07945820587	2 pcs/box
	PSR072FL0550	PSR072FL0550Z	07945820579	PSR072FS0550	PSR072FS0550Z	07945820588	2 pcs/box
	PSR072FL0630	PSR072FL0630Z	07945820580	PSR072FS0630	PSR072FS0630Z	07945820589	2 pcs/box
	PSR072FL0700	PSR072FL0700Z	07945827768	PSR072FS0700	PSR072FS0700Z	07945827789	2 pcs/box
	PSR072FL0800	PSR072FL0800Z	07945827769	PSR072FS0800	PSR072FS0800Z	07945827790	2 pcs/box
	PSR072FL0900	PSR072FL0900Z	07945827770	PSR072FS0900	PSR072FS0900Z	07945827793	2 pcs/box
	PSR072FL1000	PSR072FL1000Z	07945827771	PSR072FS1000	PSR072FS1000Z	07945827794	2 pcs/box
73	PSR073FL0315	PSR073FL0315Z	07945820590	PSR073FS0315	PSR073FS0315Z	07945820602	2 pcs/box
	PSR073FL0350	PSR073FL0350Z	07945820591	PSR073FS0350	PSR073FS0350Z	07945820603	2 pcs/box
	PSR073FL0400	PSR073FL0400Z	07945820592	PSR073FS0400	PSR073FS0400Z	07945820604	2 pcs/box
	PSR073FL0450	PSR073FL0450Z	07945820593	PSR073FS0450	PSR073FS0450Z	07945820605	2 pcs/box
	PSR073FL0500	PSR073FL0500Z	07945820594	PSR073FS0500	PSR073FS0500Z	07945820606	2 pcs/box
	PSR073FL0550	PSR073FL0550Z	07945820595	PSR073FS0550	PSR073FS0550Z	07945820607	2 pcs/box
	PSR073FL0630	PSR073FL0630Z	07945820596	PSR073FS0630	PSR073FS0630Z	07945820608	2 pcs/box
	PSR073FL0700	PSR073FL0700Z	07945820597	PSR073FS0700	PSR073FS0700Z	07945820609	2 pcs/box
	PSR073FL0800	PSR073FL0800Z	07945827772	PSR073FS0800	PSR073FS0800Z	07945827795	2 pcs/box
	PSR073FL0900	PSR073FL0900Z	07945827773	PSR073FS0900	PSR073FS0900Z	07945827796	2 pcs/box
	PSR073FL1000	PSR073FL1000Z	07945827774	PSR073FS1000	PSR073FS1000Z	07945827797	2 pcs/box
	PSR073FL1100	PSR073FL1100Z	07945827775	PSR073FS1100	PSR073FS1100Z	07945827798	2 pcs/box
	PSR073FL1250	PSR073FL1250Z	07945827776	PSR073FS1250	PSR073FS1250Z	07945827799	2 pcs/box
PSR073FL1400	PSR073FL1400Z	07945827777	PSR073FS1400	PSR073FS1400Z	07945827800	2 pcs/box	

POWR-SPEED® Fuse

PSR SERIES HIGH-SPEED SQUARE BODY

Dimensions

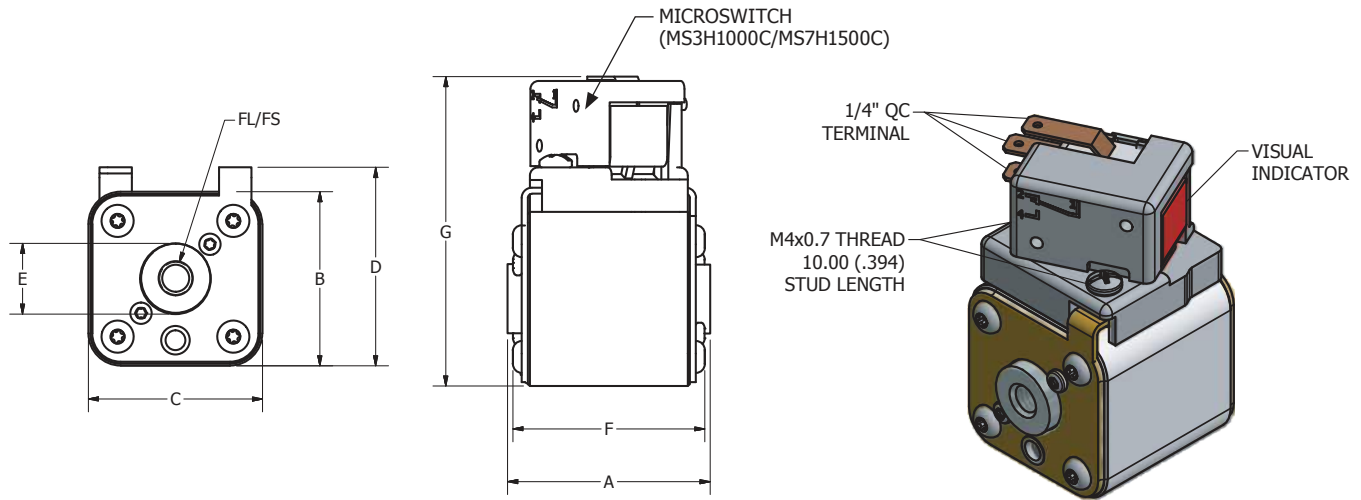

DIMENSIONS IN MM (IN)

CASE SIZE	A	B	C	D	E	F	G	FL METRIC THREAD	FS INCHES THREAD	RECOMMENDED TORQUE
30	50.0 (1.97)	43.0 (1.69)	43.0 (1.69)	49.0 (1.93)	17.0 (0.7)	47.7 (1.88)	77.9 (3.07)	M8 x 1.25	5/16"–18 UNC 2B	13–20 Nm
31	50.0 (1.97)	51.5 (2.03)	51.5 (2.03)	57.5 (2.26)	20.0 (0.8)	48.5 (1.91)	86.4 (3.40)	M8 x 1.25	5/16"–18 UNC 2B	13–20 Nm
32	51.0 (2.01)	60.0 (2.36)	60.0 (2.36)	66.0 (2.60)	23.0 (0.9)	49.2 (1.94)	94.9 (3.74)	M10 x 1.5	3/8"–16 UNC 2B	26–35 Nm
33	51.0 (2.01)	73.5 (2.89)	73.5 (2.89)	79.5 (3.13)	30.0 (1.2)	49.5 (1.95)	108.4 (4.27)	M12 x 1.75	1/2"–13 UNC 2B	45–55 Nm
70	74.0 (2.91)	43.0 (1.69)	43.0 (1.69)	49.0 (1.93)	17.0 (0.7)	71.7 (2.82)	77.9 (3.07)	M8 x 1.25	5/16"–18 UNC 2B	13–20 Nm
71	74.0 (2.91)	51.5 (2.03)	51.5 (2.03)	57.5 (2.26)	20.0 (0.8)	72.5 (2.85)	86.4 (3.40)	M8 x 1.25	5/16"–18 UNC 2B	13–20 Nm
72	75.0 (2.95)	60.0 (2.36)	60.0 (2.36)	66.0 (2.60)	23.0 (0.9)	73.2 (2.88)	94.9 (3.736)	M10 x 1.5	3/8"–16 UNC 2B	26–35 Nm
73	75.0 (2.95)	73.5 (2.89)	73.5 (2.89)	79.5 (3.13)	30.0 (1.2)	73.5 (2.89)	108.4 (4.27)	M12 x 1.75	1/2"–13 UNC 2B	45–55 Nm

Recommended mounting

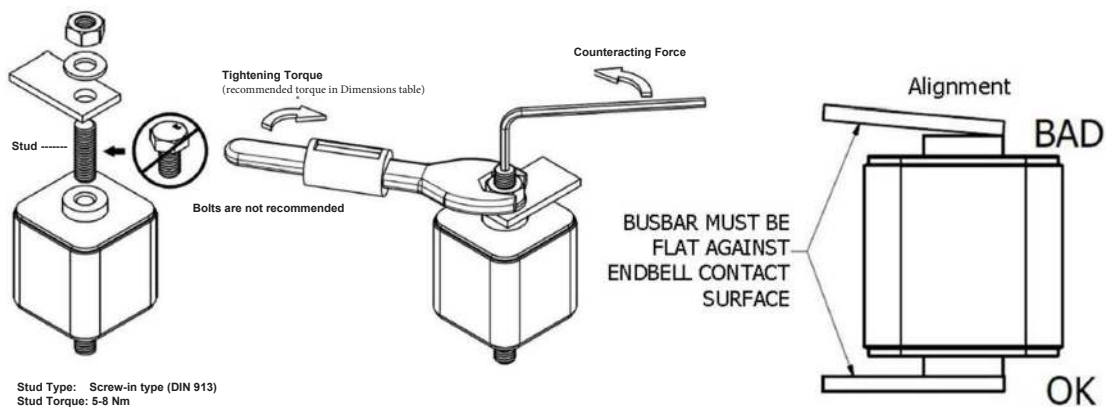

POWR-SPEED® Fuse

PSR SERIES HIGH-SPEED SQUARE BODY

Time Current Curve (30 Case Size)

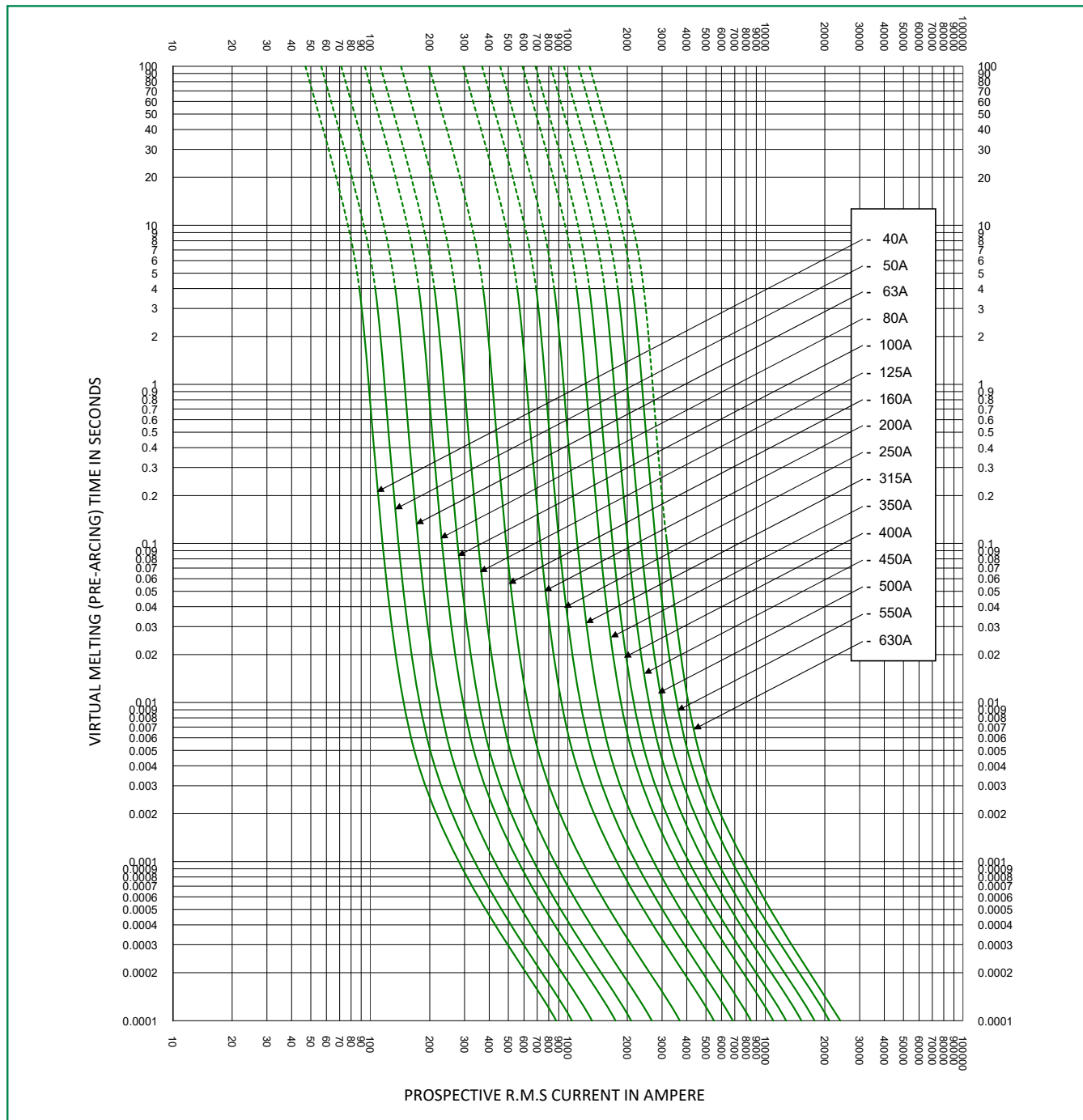

* Dc minimum breaking capacity = 9 x rated current of fuse

POWR-SPEED® Fuse

PSR SERIES HIGH-SPEED SQUARE BODY

Time Current Curve (31 Case Size)

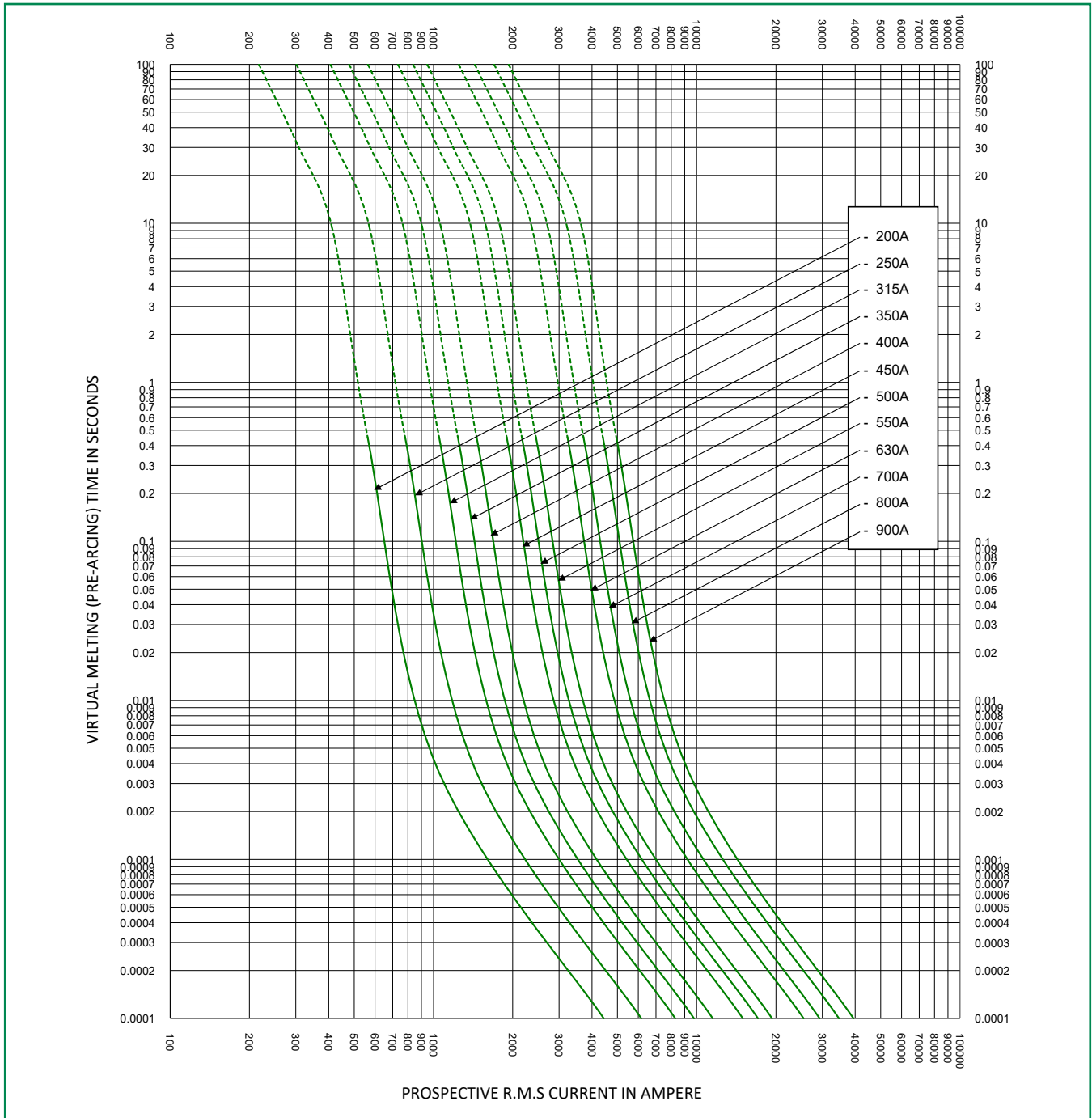

* Dc minimum breaking capacity = 9 x rated current of fuse

Time Current Curve (32 Case Size)

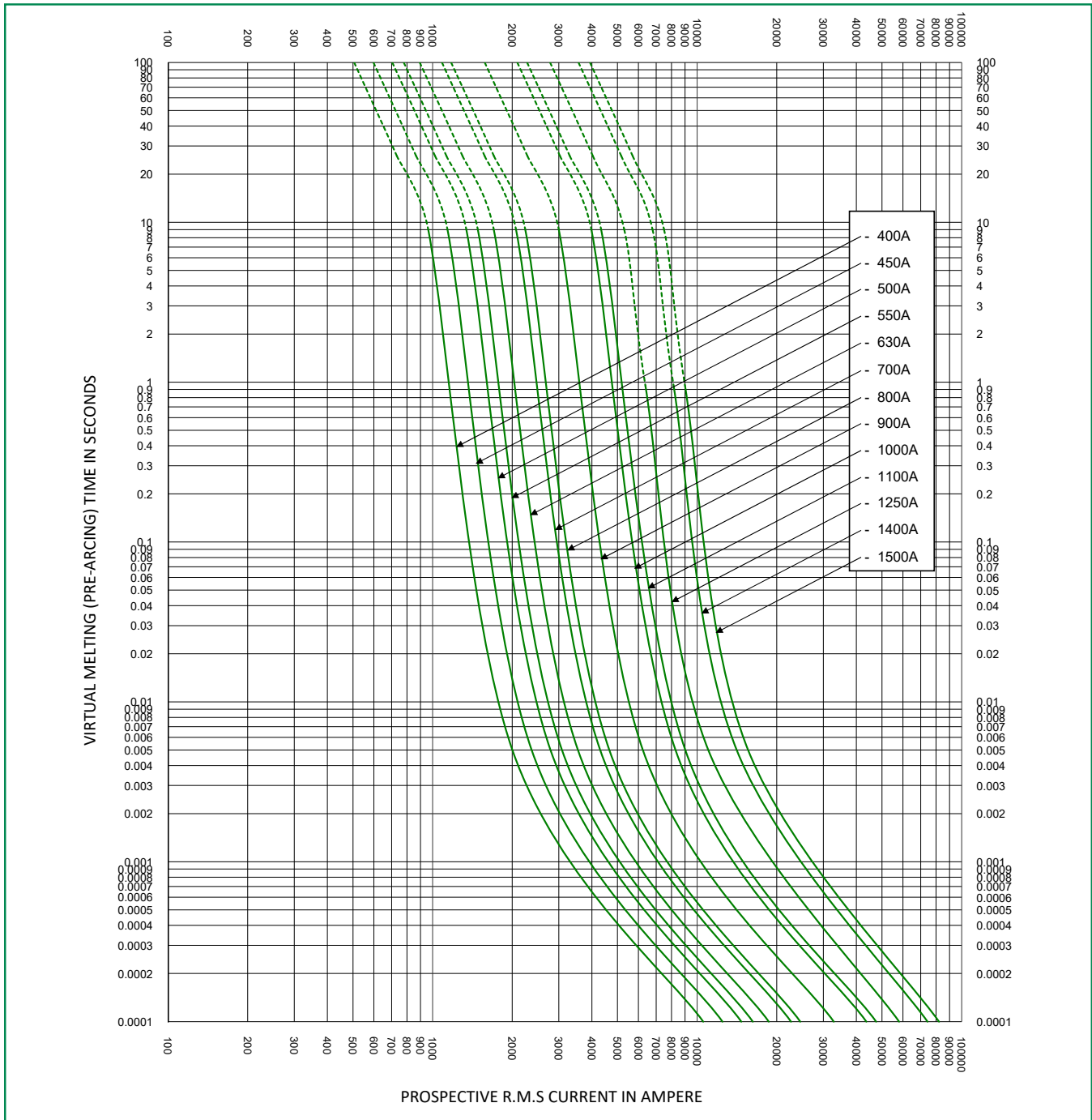

* Dc minimum breaking capacity = 9 x rated current of fuse

POWR-SPEED® Fuse

PSR SERIES HIGH-SPEED SQUARE BODY

Time Current Curve (33 Case Size)

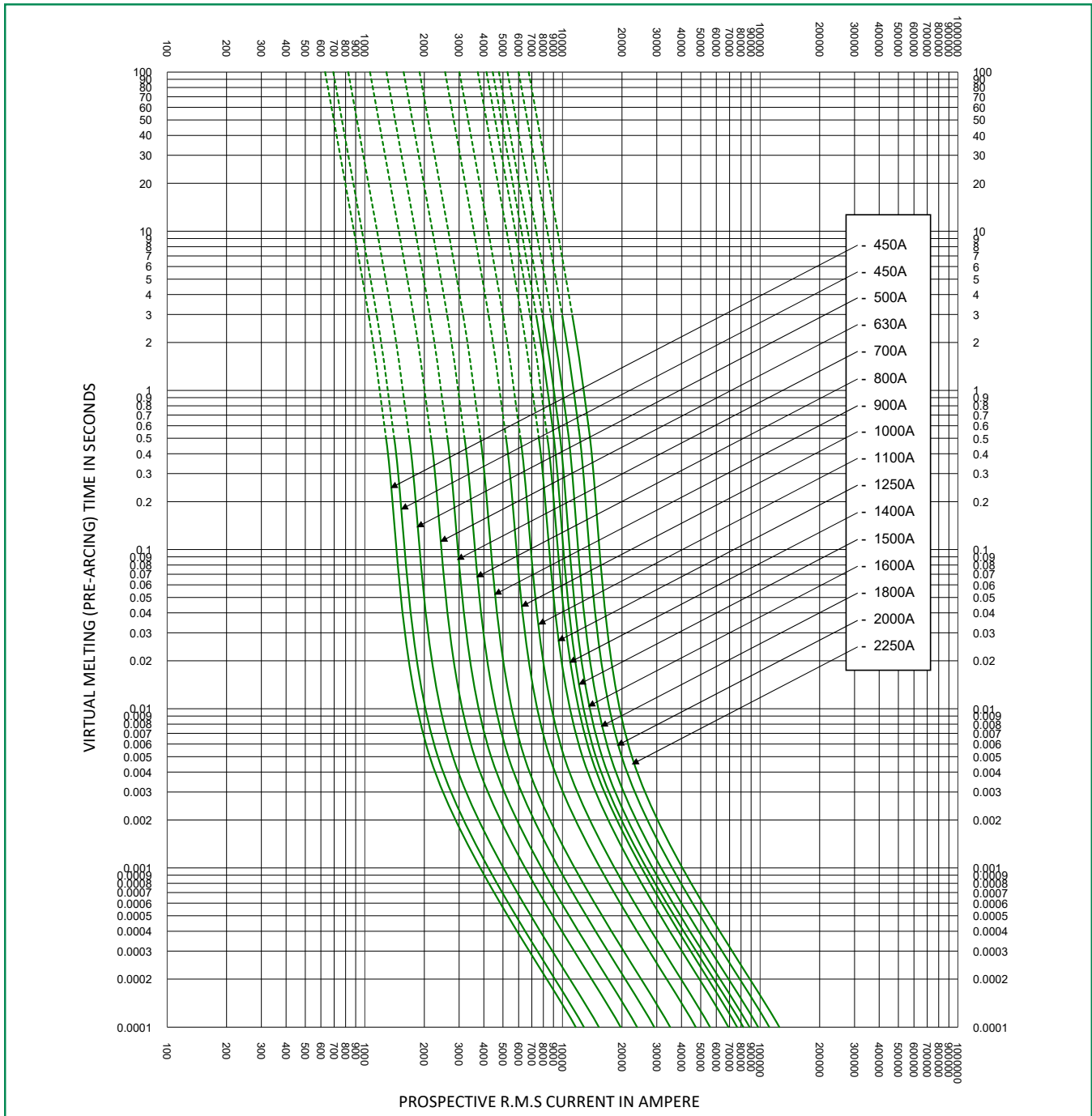

* Dc minimum breaking capacity = 9 x rated current of fuse

POWR-SPEED® Fuse

PSR SERIES HIGH-SPEED SQUARE BODY

Time Current Curve (70 Case Size)

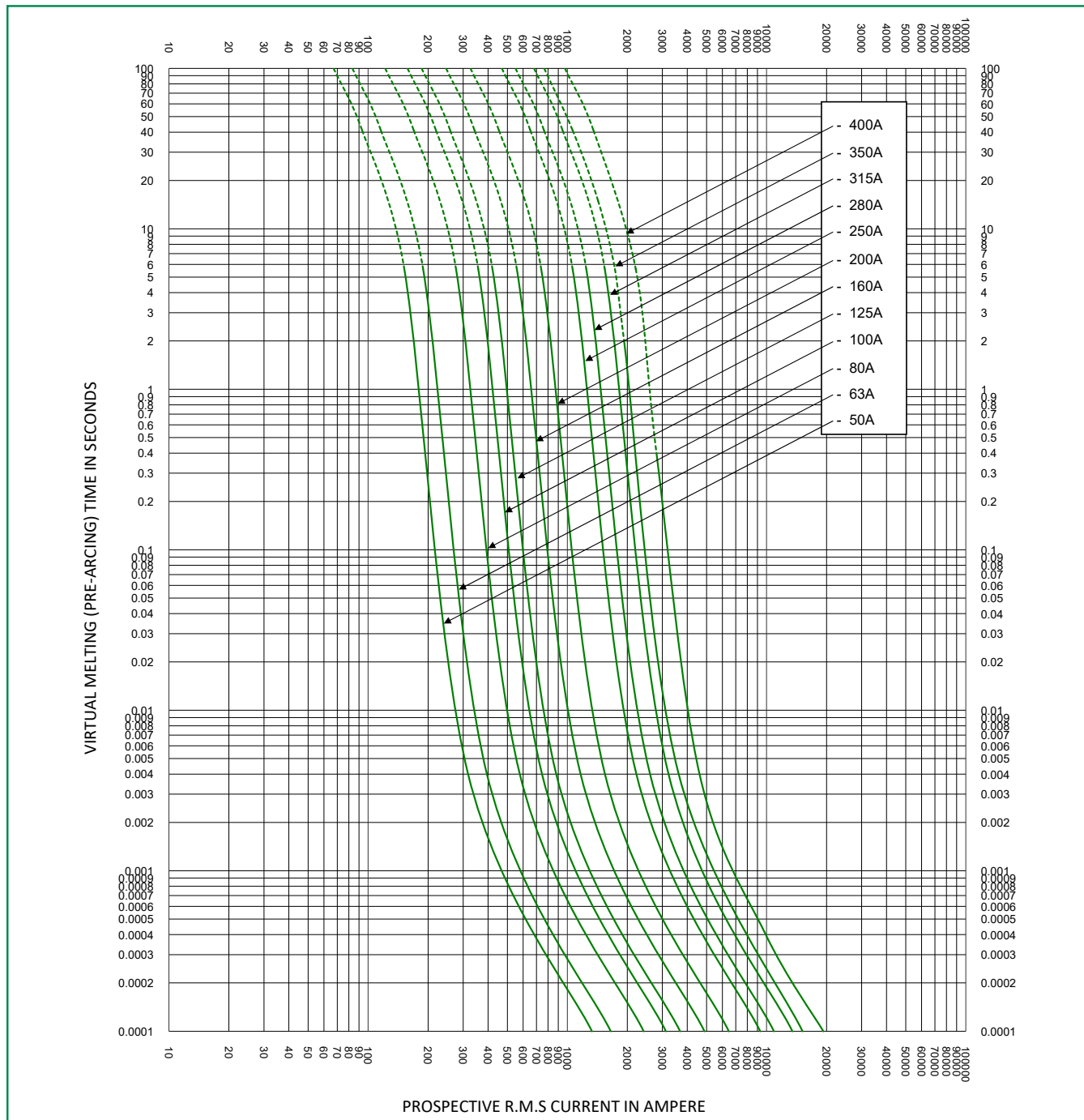

* Dc minimum breaking capacity = 9 x rated current of fuse

Time Current Curve (71 Case Size)

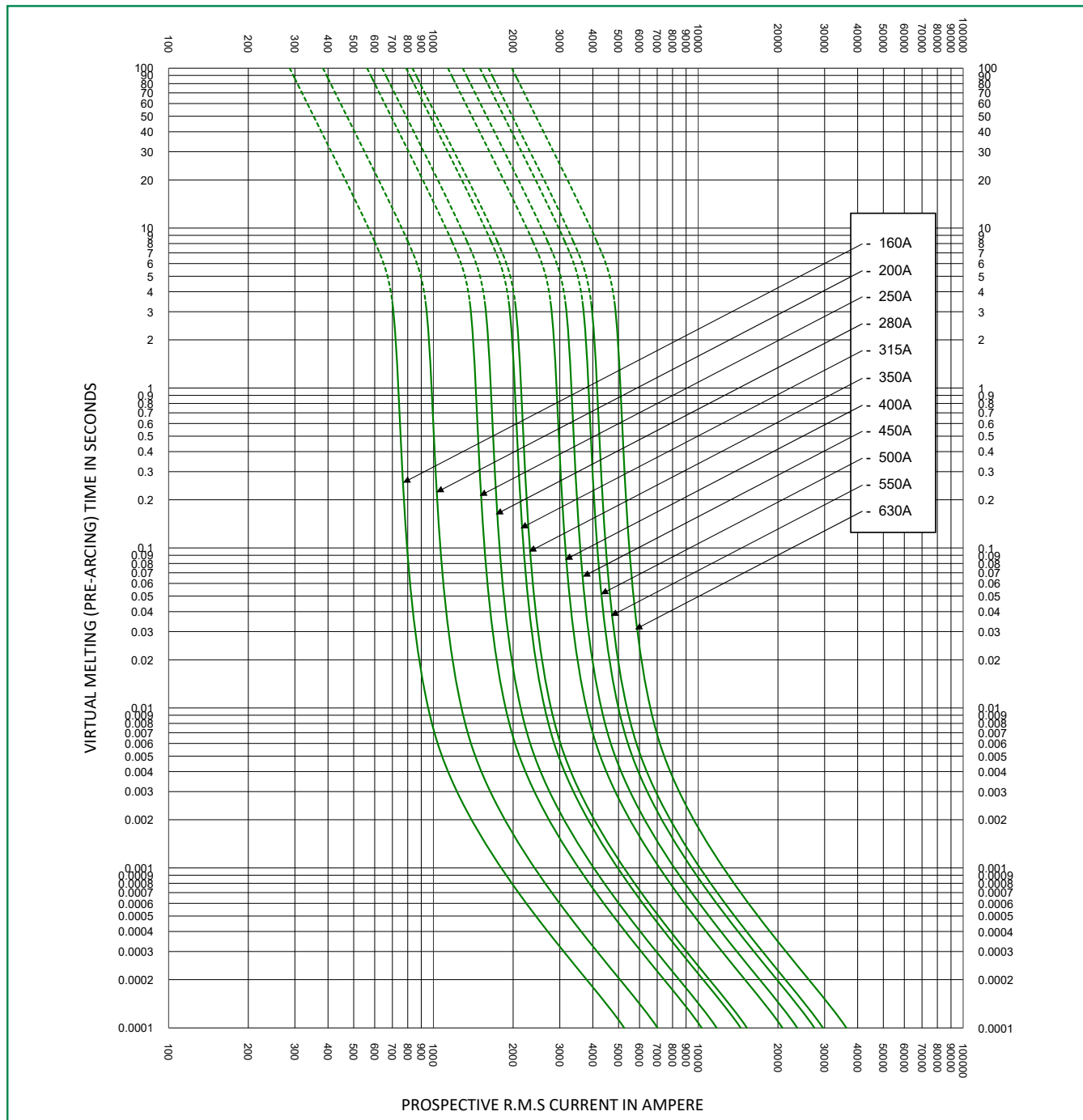

* Dc minimum breaking capacity = 9 x rated current of fuse

POWR-SPEED® Fuse

PSR SERIES HIGH-SPEED SQUARE BODY

Time Current Curve (72 Case Size)

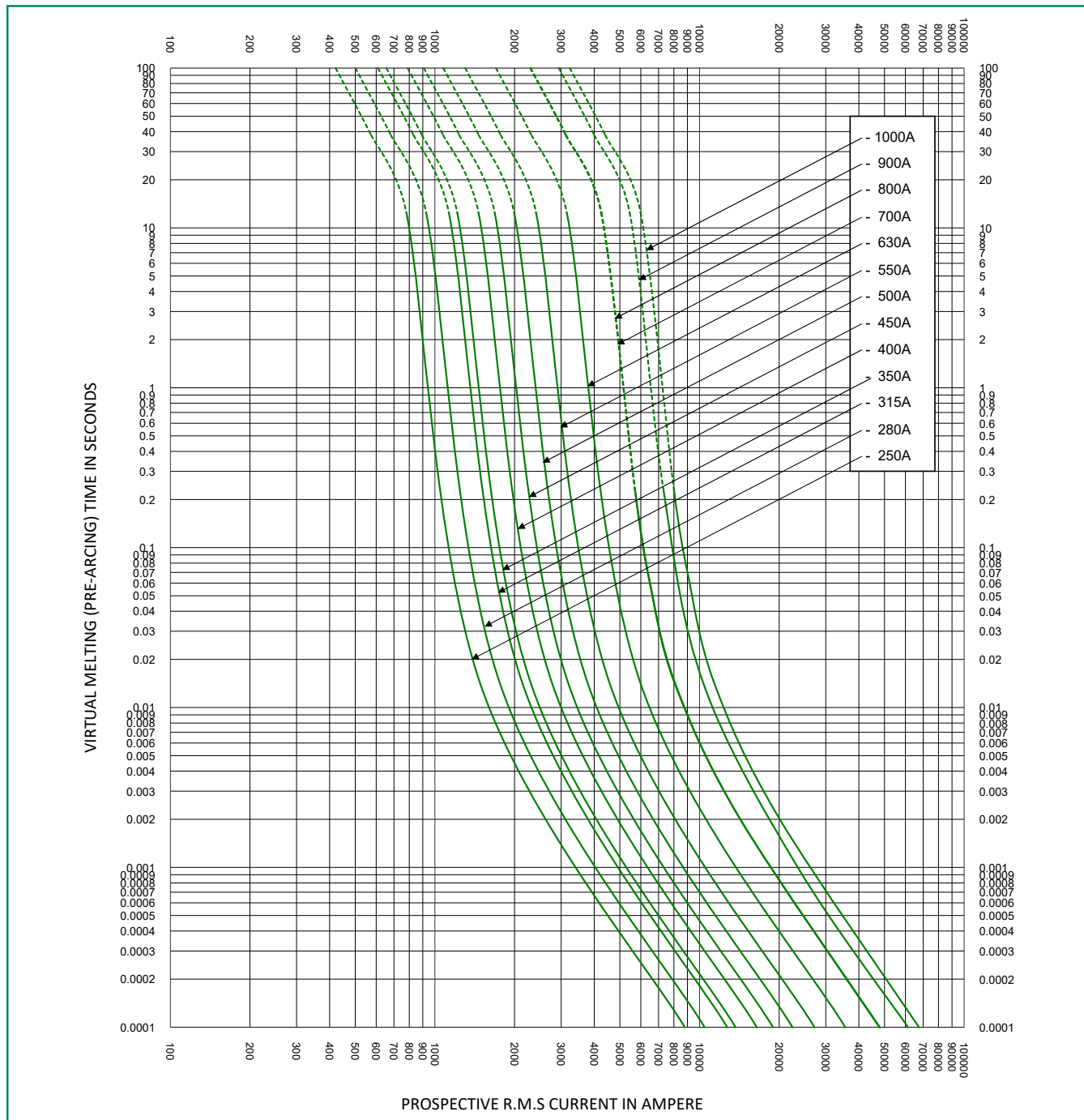

* Dc minimum breaking capacity = 9 x rated current of fuse

POWR-SPEED® Fuse

PSR SERIES HIGH-SPEED SQUARE BODY

Time Current Curve (73 Case Size)

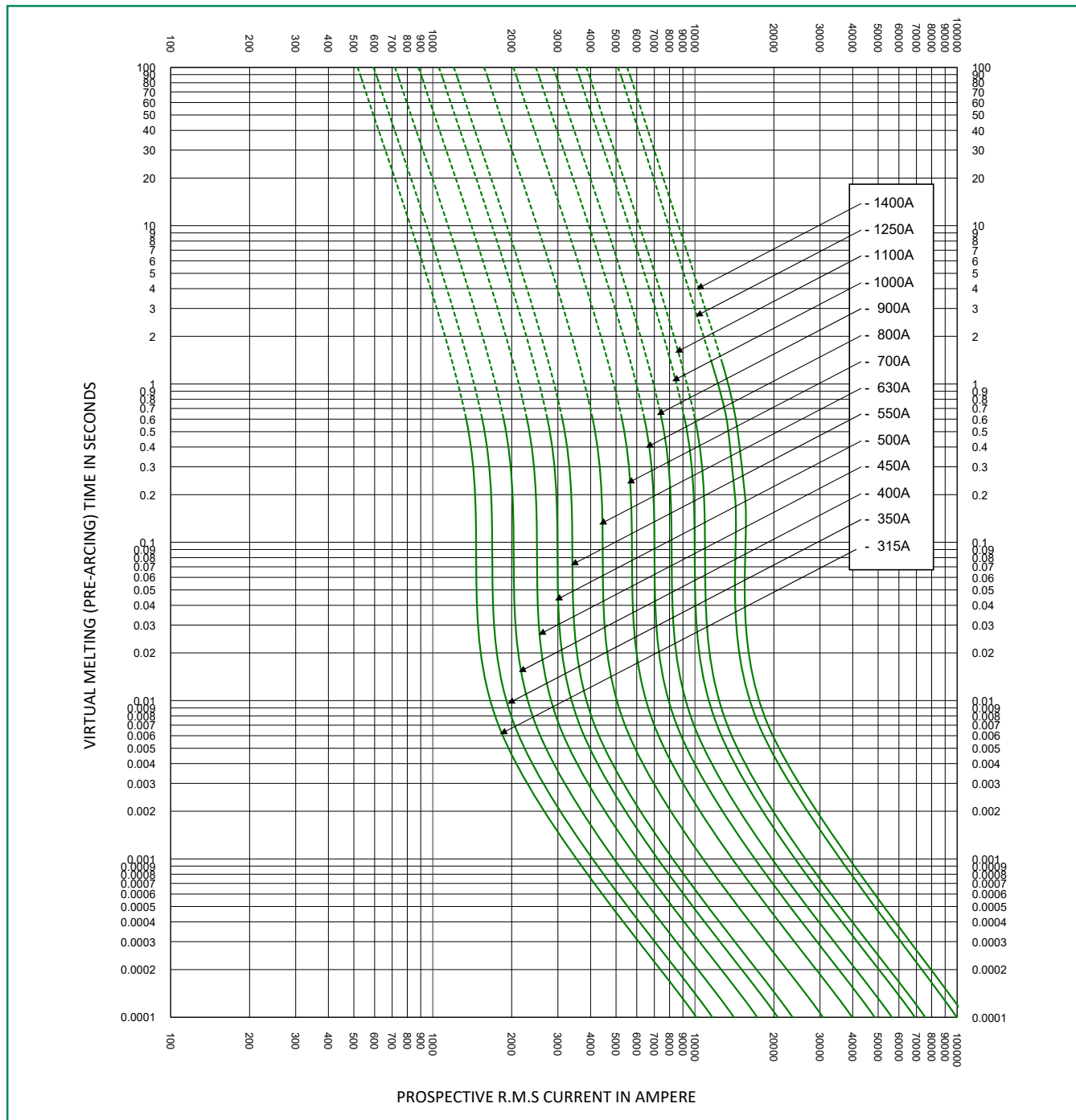

* Dc minimum breaking capacity = 9 x rated current of fuse

Peak Let-Through Curve (30 Case Size)

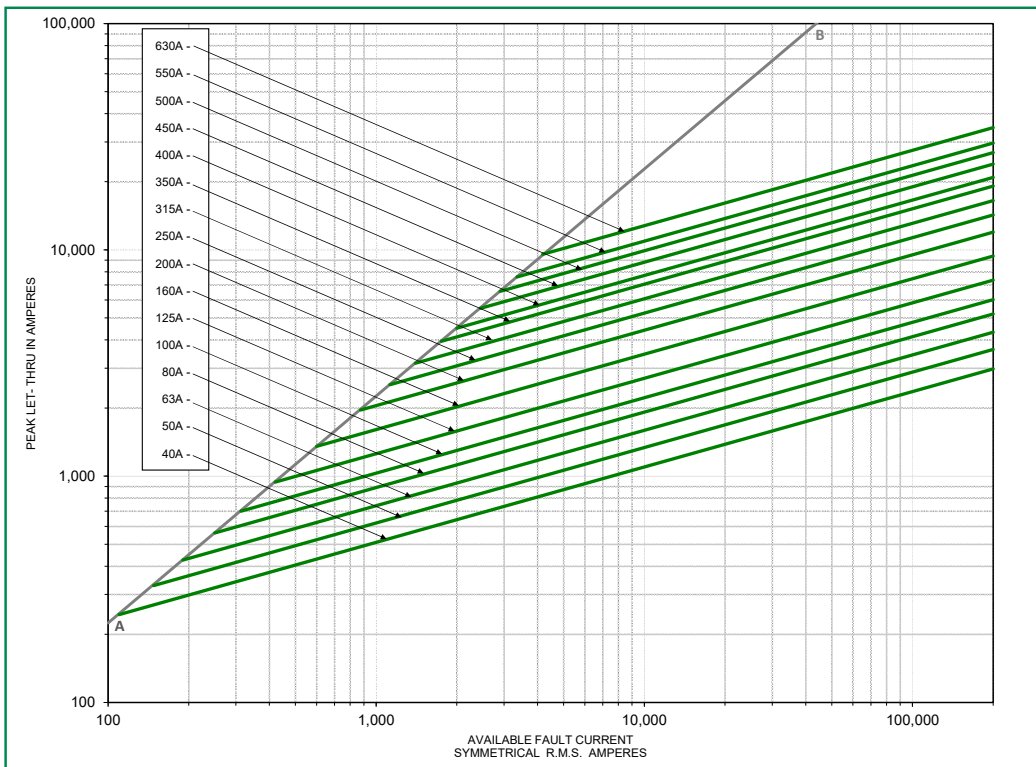

Peak Let-Through Curve (31 Case Size)

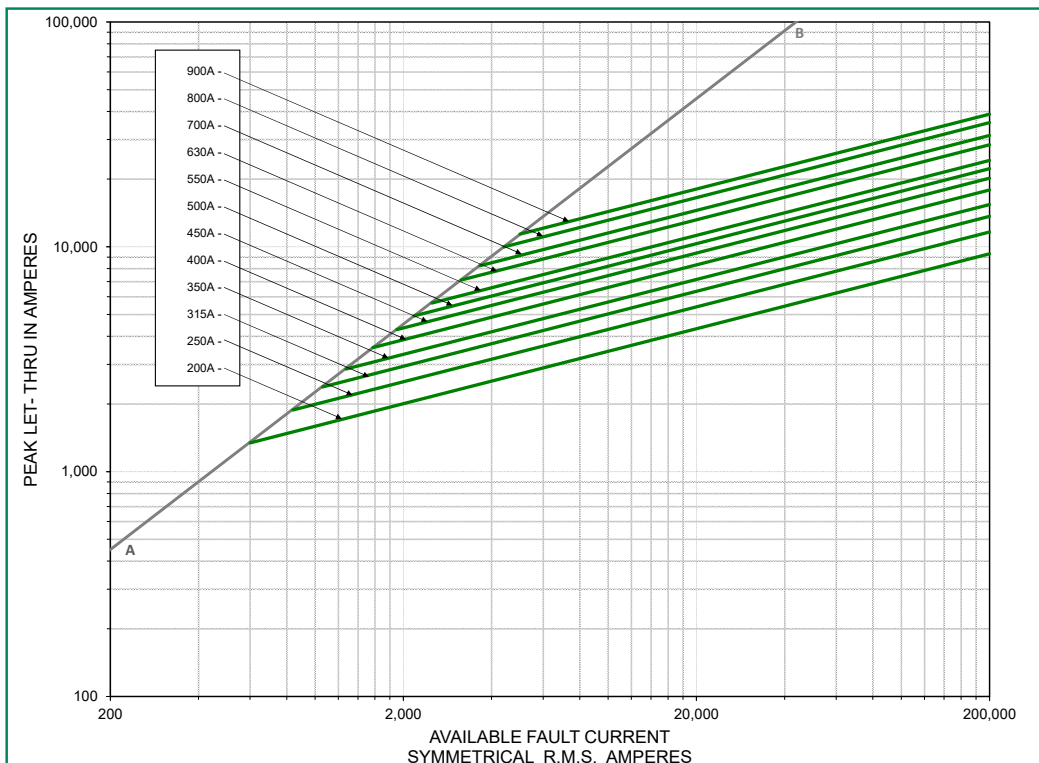

Peak Let-Thru Curve (32 Case Size)

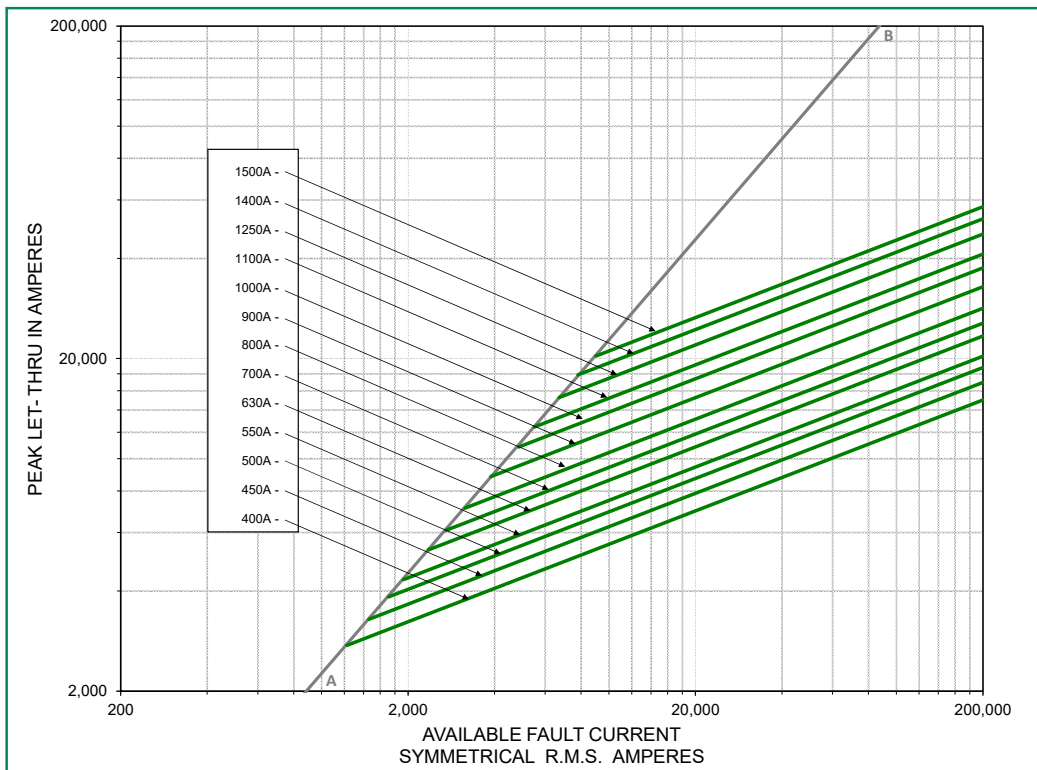

Peak Let-Thru Curve (33 Case Size)

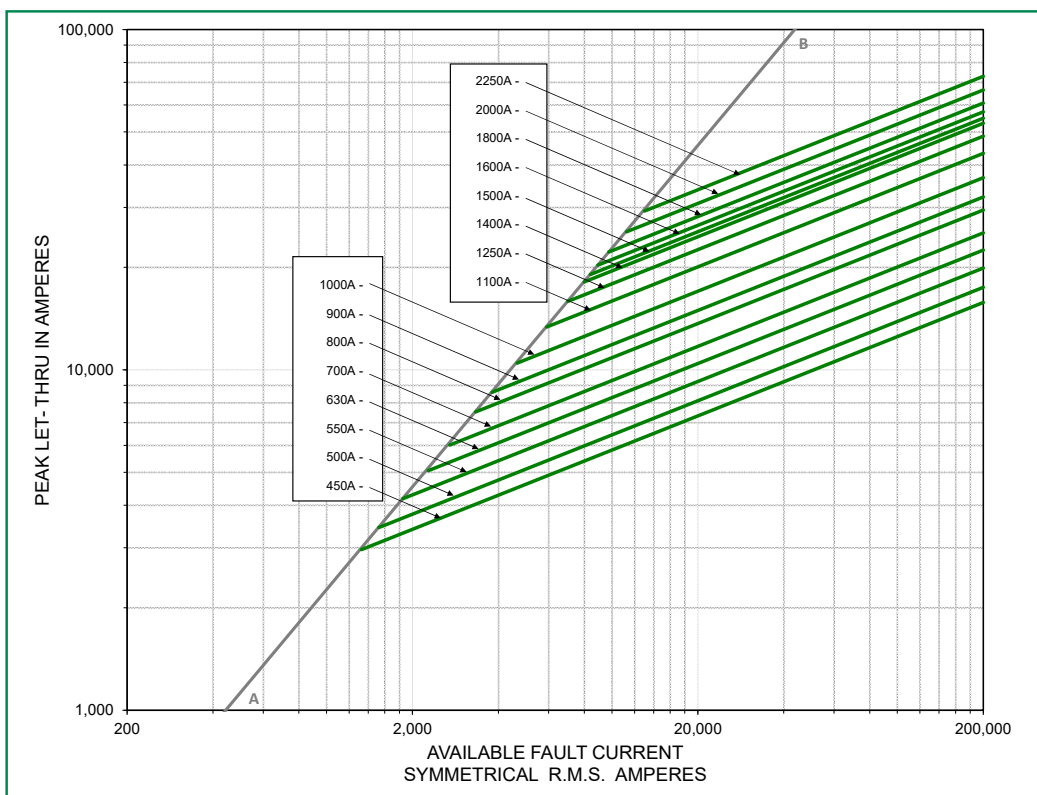

Peak Let-Thru Curve (70 Case Size)

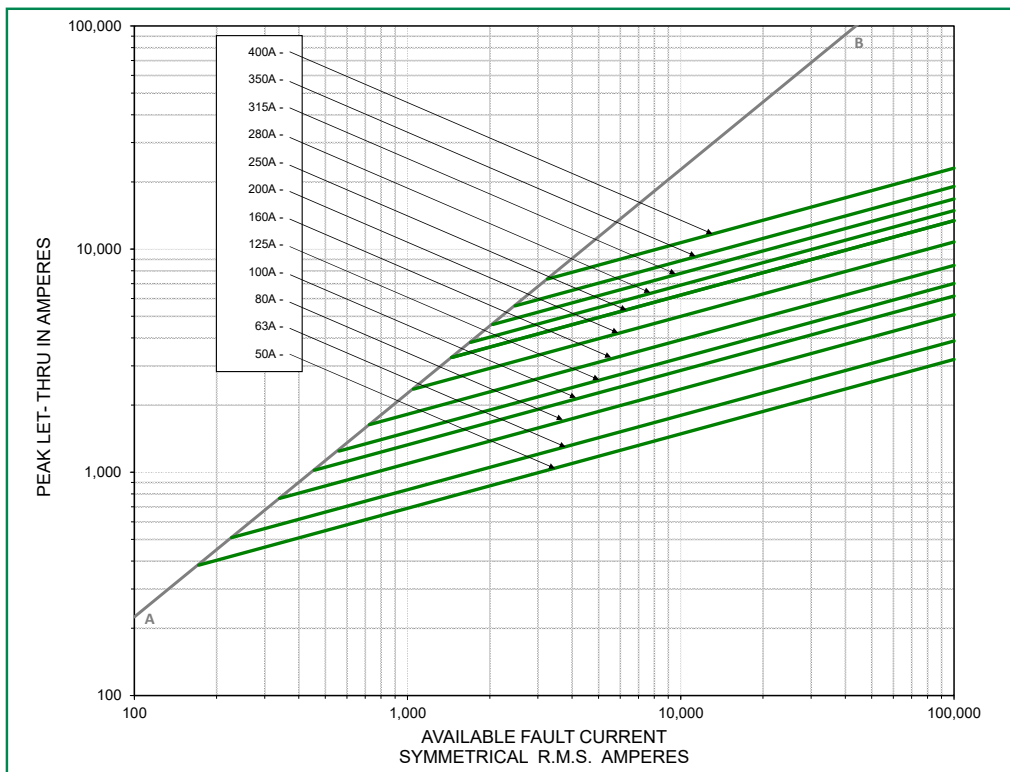

Peak Let-Thru Curve (71 Case Size)

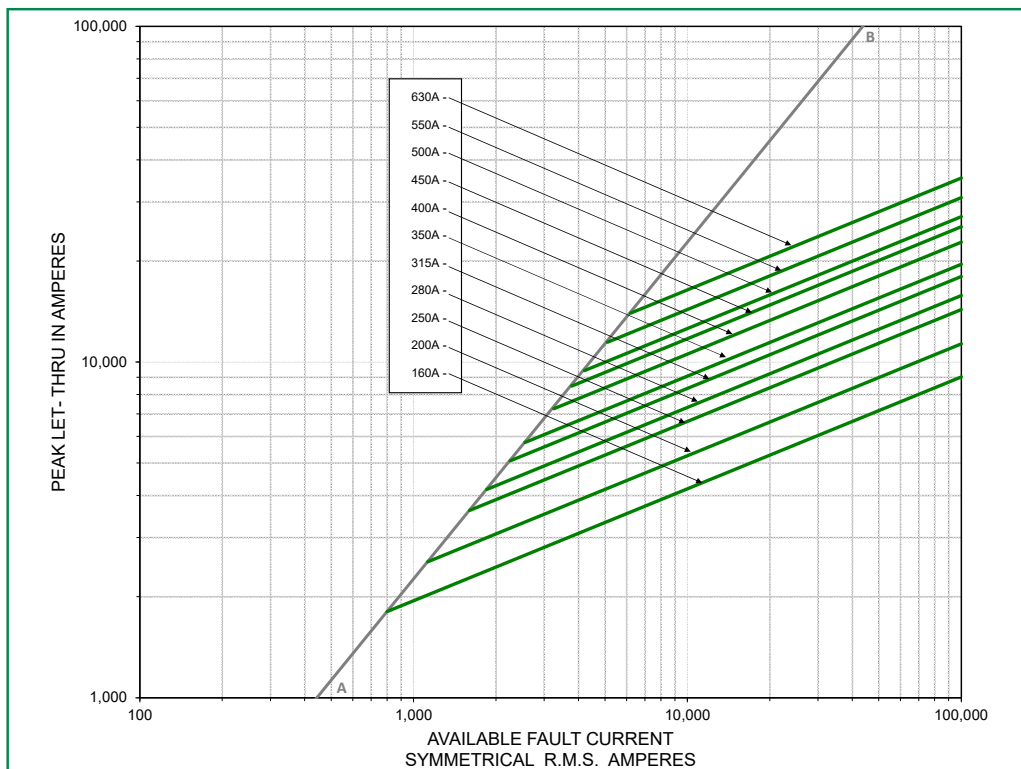

Peak Let-Thru Curve (72 Case Size)

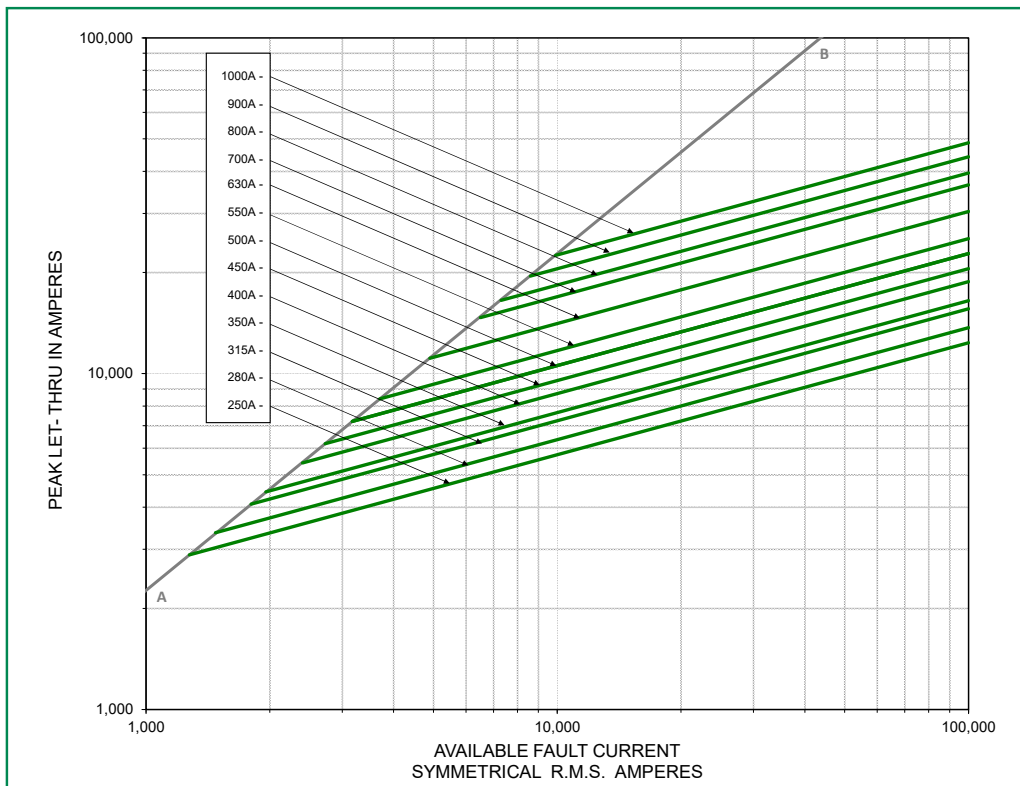

Peak Let-Thru Curve (73 Case Size)

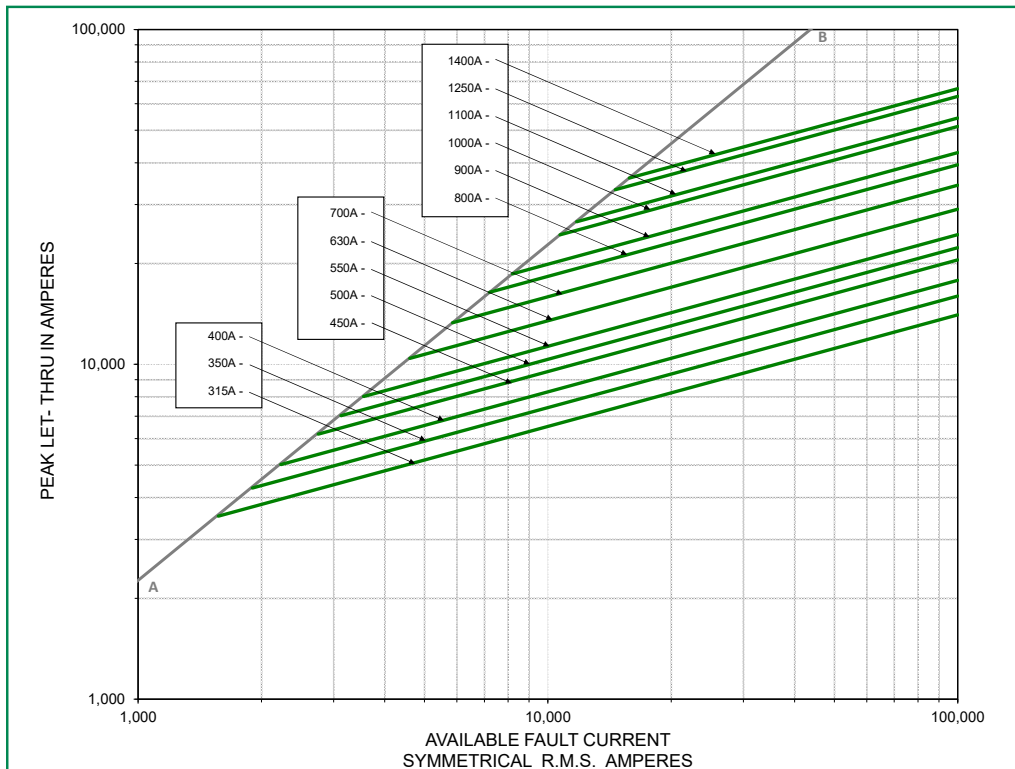

Total Clearing I²t Correction Factor Curve
(30, 31, 32 and 33 Case Sizes)

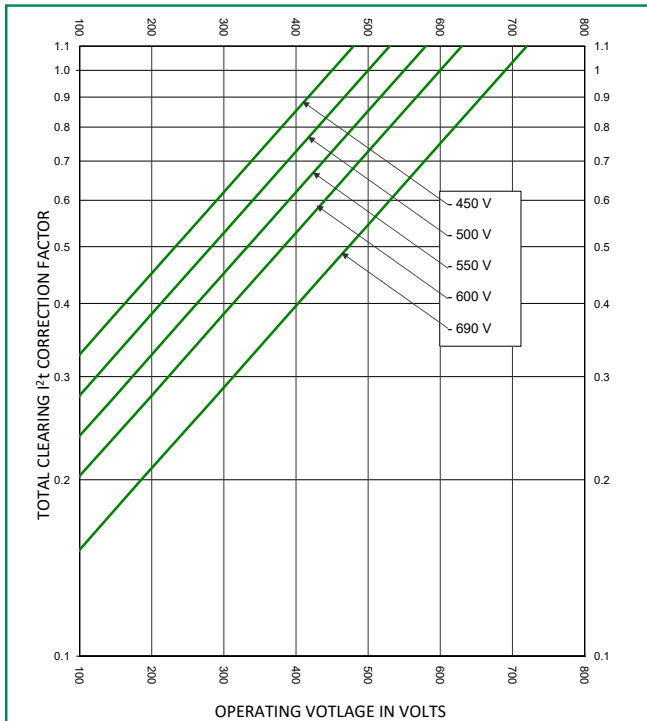

Total Clearing I²t Correction Factor Curve
(70, 71, 72 and 73 Case Sizes)

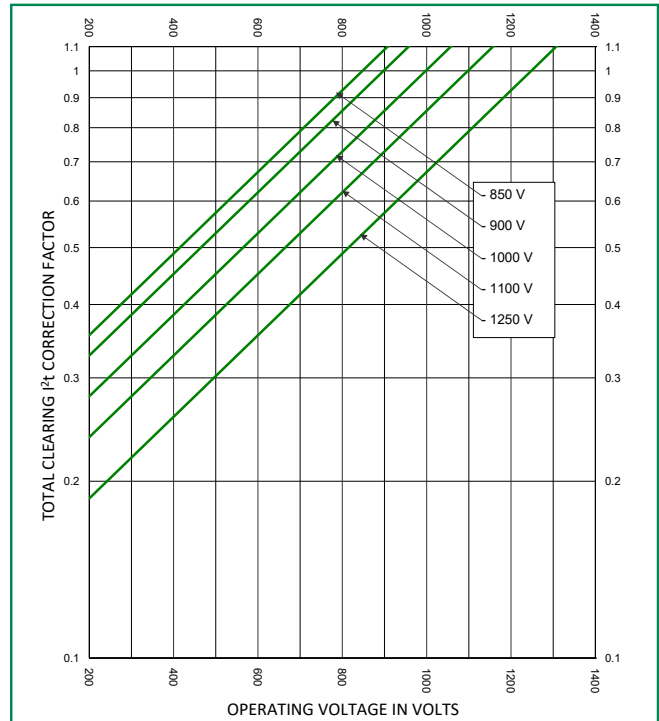

Peak Arc Voltage Curve
(30, 31, 32 and 33 Case Sizes)

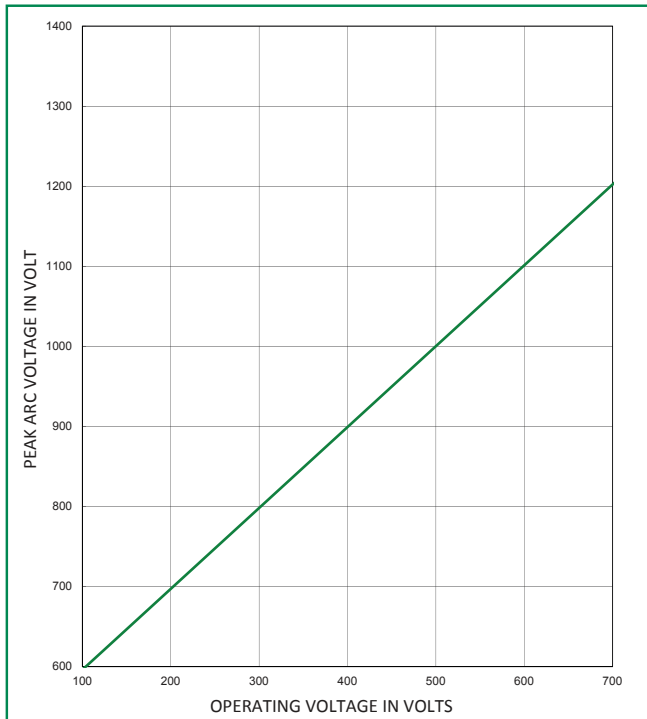

Peak Arc Voltage Curve
(70, 71, 72 and 73 Case Sizes)

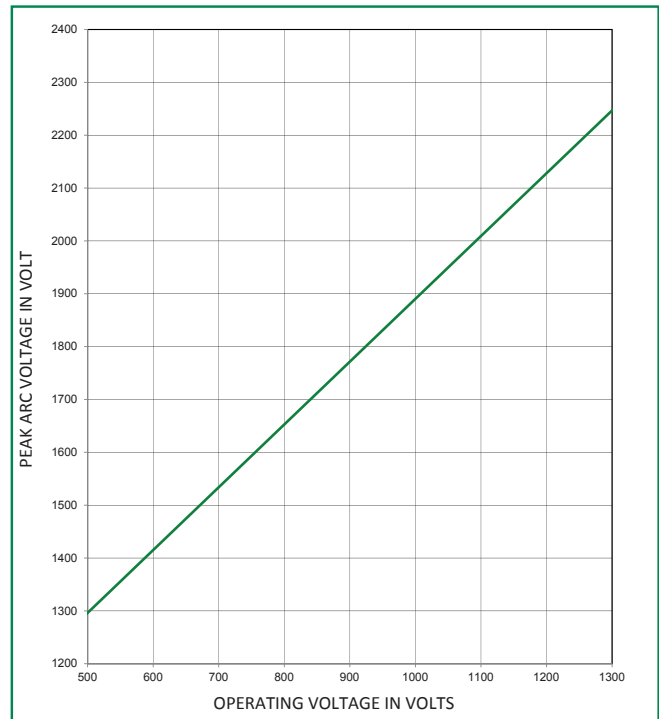

Temperature Derating Curve
 (temperature of air immediately surrounding fuse)

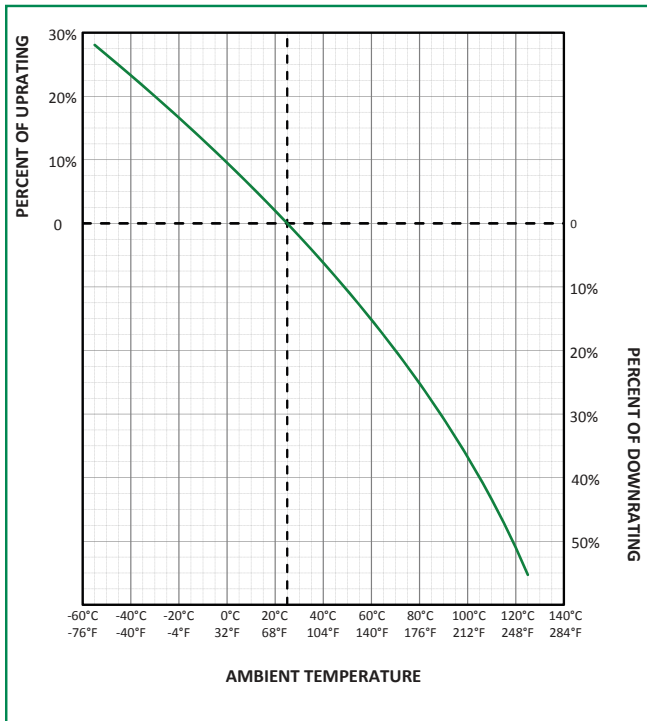

Watts Loss Correction Factor Curve

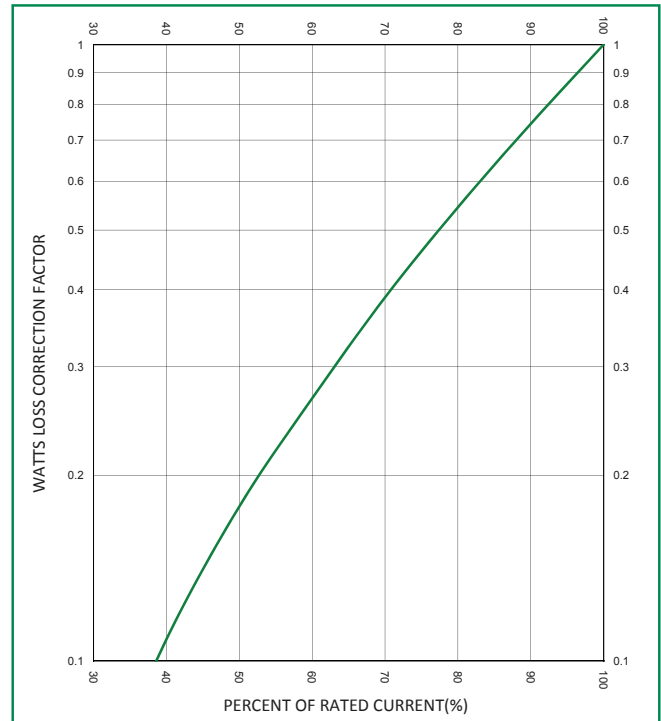

Disclaimer Notice – Information furnished is believed to be accurate and reliable. However, users should independently evaluate the suitability of and test each product selected for their own applications. Littelfuse products are not designed for, and may not be used in, all applications. Read complete Disclaimer Notice at www.littelfuse.com/product-disclaimer.