

LISA3-O-PIN

~15° x 50° oval beam with location pin installation

SPECIFICATION:

Dimensions	Ø 10.0 mm
Height	7.9 mm
Fastening	glue
ROHS compliant	yes ⓘ



MATERIALS:

Component	Type	Material	Colour	Finish
LISA3-O	Single lens	PMMA	clear	
LISA3-HLD-PIN	Holder	PC	black	



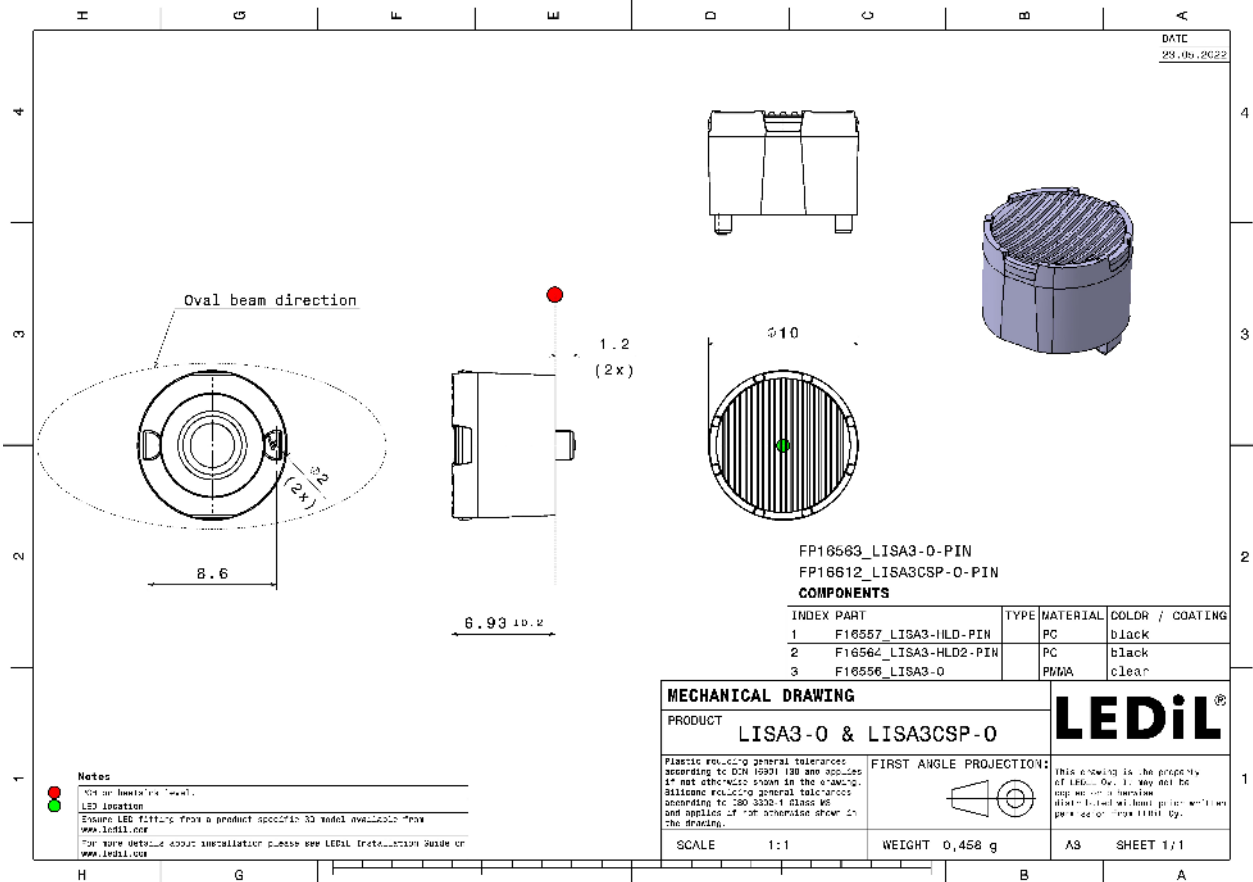

ORDERING INFORMATION:

Component		Qty in box	MOQ	MPQ	Box weight (kg)
FP16563_LISA3-O-PIN	Single lens	2000	300	100	1.3
» Box size: 310 x 230 x 60 mm					



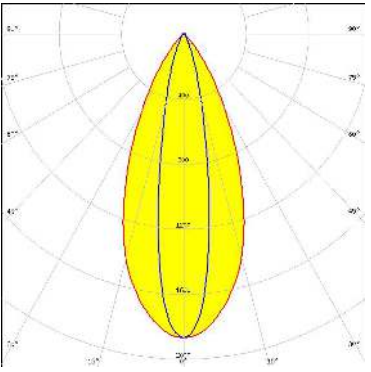

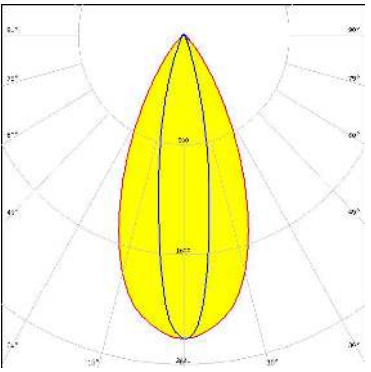
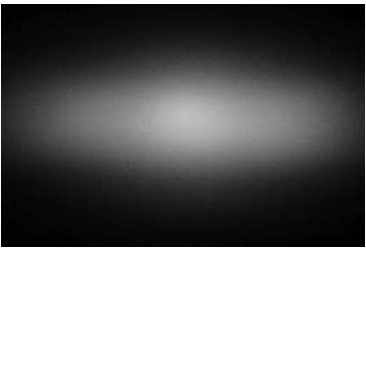
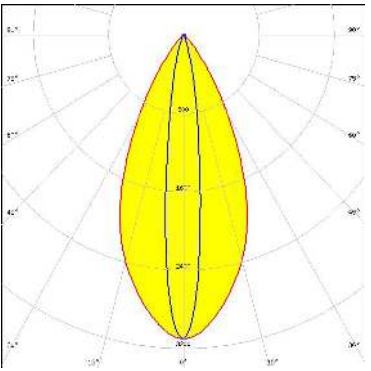

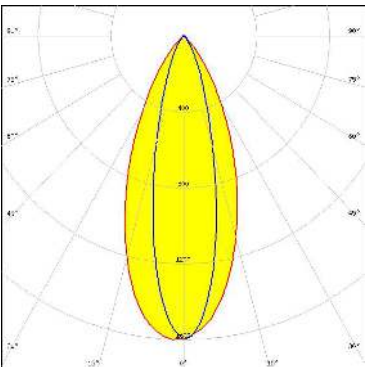
See also our general installation guide: www.ledil.com/installation_guide

OPTICAL RESULTS (MEASURED):

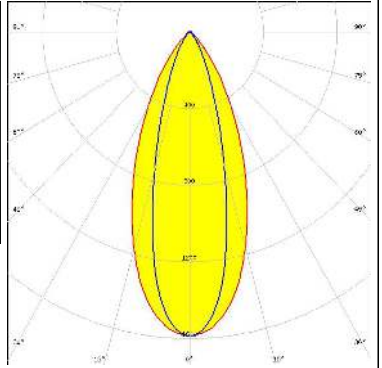
<p>CREE LEDs</p> <p>LED XD16 FWHM / FWTM 45.0 + 20.0° / 78.0 + 43.0° Efficiency 65 % Peak intensity 1.9 cd/lm LEDs/each optic 1 Light colour White Required components:</p>		
<p>CREE LEDs</p> <p>LED XP-E2 FWHM / FWTM 48.0 + 20.0° / 79.0 + 41.0° Efficiency 78 % Peak intensity 2.3 cd/lm LEDs/each optic 1 Light colour White Required components:</p>		
<p>LUMILEDS</p> <p>LED LUXEON CZ FWHM / FWTM 49.0 + 14.0° / 76.0 + 31.0° Efficiency 76 % Peak intensity 3.1 cd/lm LEDs/each optic 1 Light colour White Required components:</p>		
<p>NICHIA</p> <p>LED NF2x757G FWHM / FWTM 33.0° / 64.0° Efficiency 66 % Peak intensity 1.6 cd/lm LEDs/each optic 1 Light colour White Required components:</p>		

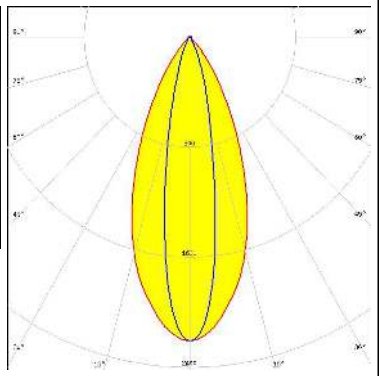
OPTICAL RESULTS (MEASURED):

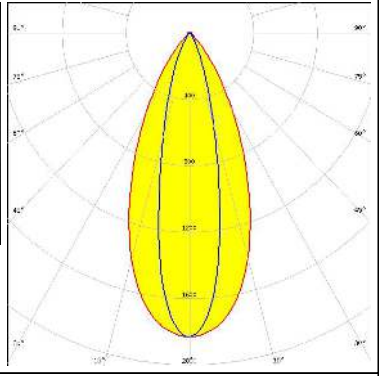
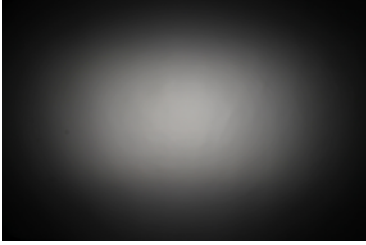
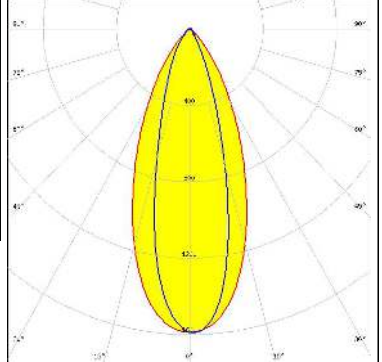
<p>NICHIA</p> <p>LED NVSW219F FWHM / FWTM 45.0 + 29.0° / 81.0 + 58.0° Efficiency 77 % Peak intensity 1.6 cd/lm LEDs/each optic 1 Light colour White Required components:</p>		
<p>OSRAM Opto Semiconductors</p> <p>LED OSCONIQ C 2424 FWHM / FWTM 44.0 + 20.0° / 77.0 + 43.0° Efficiency 74 % Peak intensity 2.2 cd/lm LEDs/each optic 1 Light colour White Required components:</p>		
<p>OSRAM Opto Semiconductors</p> <p>LED OSLOM Square CSSRM2/CSSRM3 FWHM / FWTM 46.0 + 24.0° / 80.0 + 50.0° Efficiency 75 % Peak intensity 1.8 cd/lm LEDs/each optic 1 Light colour White Required components:</p>		
<p>SAMSUNG</p> <p>LED LH351C FWHM / FWTM 45.0 + 28.0° / 81.0 + 59.0° Efficiency 77 % Peak intensity 1.6 cd/lm LEDs/each optic 1 Light colour White Required components:</p>		

OPTICAL RESULTS (MEASURED):

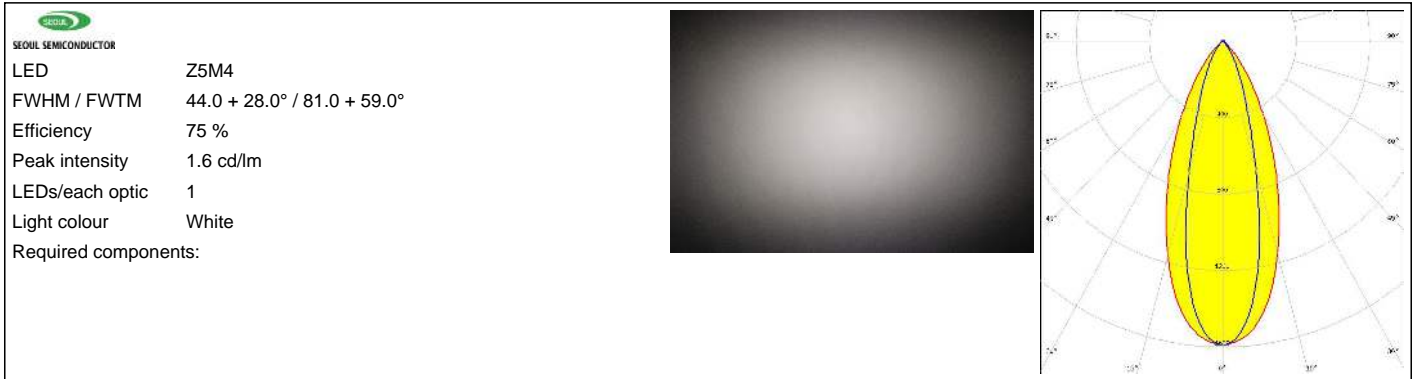

OPTICAL RESULTS (SIMULATED):

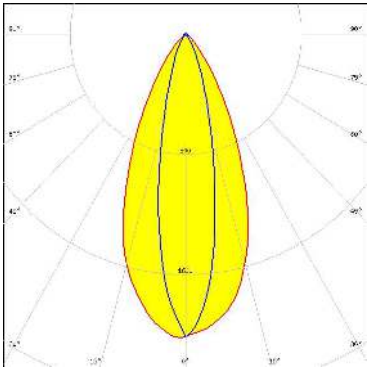
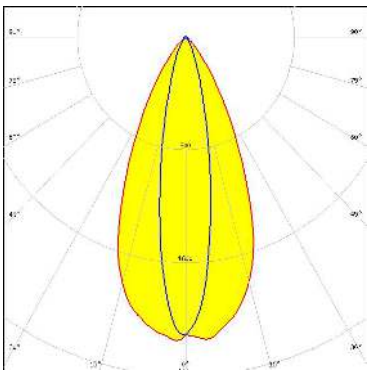
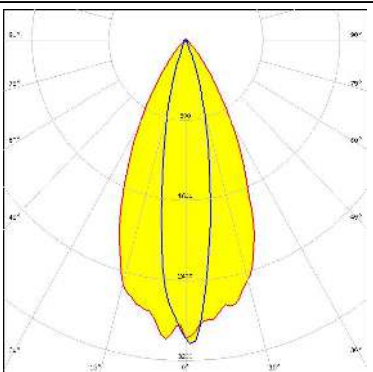
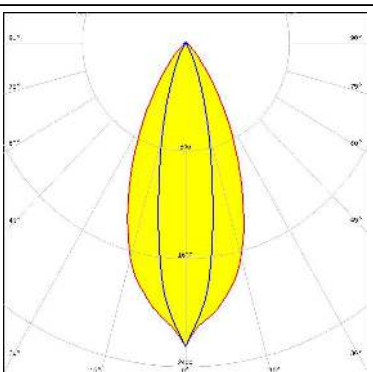
<p>CREE LEDs</p> <p>LED J Series 2835 FWHM / FWTM 46.0 + 22.0° / 78.0 + 48.0° Efficiency 81 % Peak intensity 2 cd/lm LEDs/each optic 1 Light colour White Required components:</p>	
<p>CREE LEDs</p> <p>LED J Series 2835 FWHM / FWTM 48.0 + 20.0° / 78.0 + 44.0° Efficiency 82 % Peak intensity 2.2 cd/lm LEDs/each optic 1 Light colour White Required components:</p>	
<p>CREE LEDs</p> <p>LED XP-E FWHM / FWTM 17.0 + 48.0° / 36.0 + 74.0° Efficiency 85 % Peak intensity 2.7 cd/lm LEDs/each optic 1 Light colour White Required components:</p>	
<p>CREE LEDs</p> <p>LED XP-G2 FWHM / FWTM 46.0 + 22.0° / 78.0 + 46.0° Efficiency 83 % Peak intensity 2.3 cd/lm LEDs/each optic 1 Light colour White Required components:</p>	



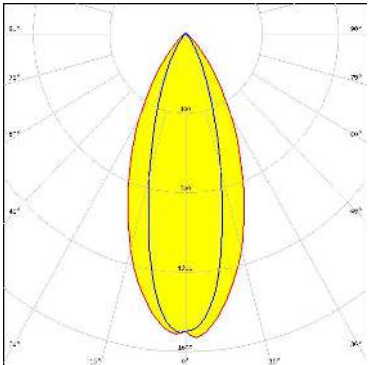
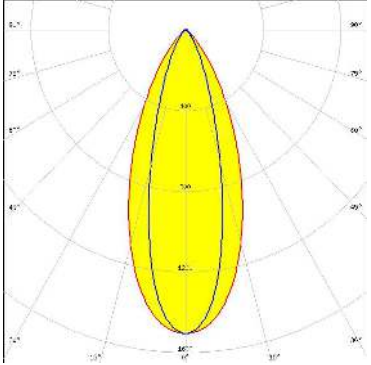
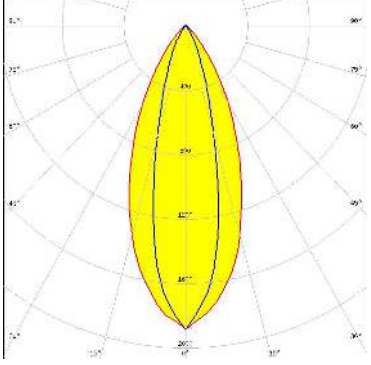
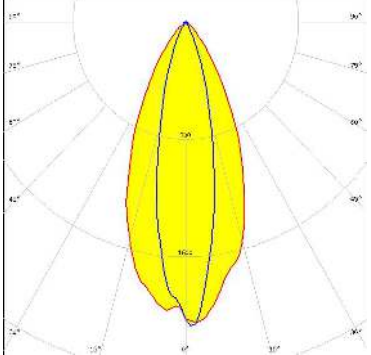



OPTICAL RESULTS (SIMULATED):

<p>CREE LEDs</p> <p>LED: XP-G2 HE FWHM / FWTM: 46.0 + 29.0° / 84.0 + 61.0° Efficiency: 77 % Peak intensity: 1.5 cd/lm LEDs/each optic: 1 Light colour: White Required components:</p>	
<p>CREE LEDs</p> <p>LED: XP-G3 FWHM / FWTM: 44.0 + 29.0° / 81.0 + 59.0° Efficiency: 73 % Peak intensity: 1.5 cd/lm LEDs/each optic: 1 Light colour: White Required components:</p>	
<p>LUMILEDS</p> <p>LED: LUXEON HL2X FWHM / FWTM: 44.0 + 25.0° / 80.0 + 53.0° Efficiency: 81 % Peak intensity: 1.9 cd/lm LEDs/each optic: 1 Light colour: White Required components:</p>	
<p>LUMILEDS</p> <p>LED: LUXEON TX FWHM / FWTM: 22.0 + 46.0° / 46.0 + 80.0° Efficiency: 80 % Peak intensity: 2.1 cd/lm LEDs/each optic: 1 Light colour: White Required components:</p>	

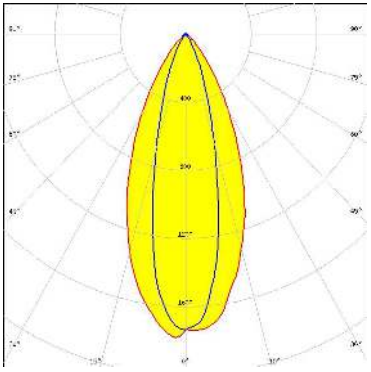
OPTICAL RESULTS (SIMULATED):

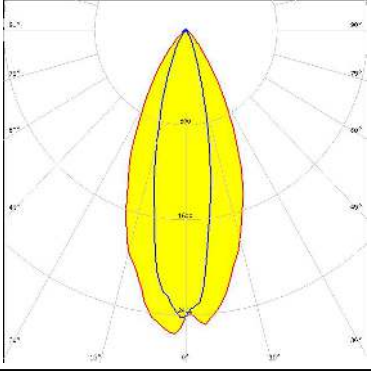
<p>LUMILEDS</p> <p>LED: LUXEON V2</p> <p>FWHM / FWTM: 25.0 + 47.0° / 53.0 + 81.0°</p> <p>Efficiency: 83 %</p> <p>Peak intensity: 1.9 cd/lm</p> <p>LEDs/each optic: 1</p> <p>Light colour: White</p> <p>Required components:</p>	
<p>LUMILEDS</p> <p>LED: LUXEON Z</p> <p>FWHM / FWTM: 12.0 + 50.0° / 25.0 + 74.0°</p> <p>Efficiency: 84 %</p> <p>Peak intensity: 3.3 cd/lm</p> <p>LEDs/each optic: 1</p> <p>Light colour: White</p> <p>Required components:</p>	
<p>LUMILEDS</p> <p>LED: LUXEON Z ES</p> <p>FWHM / FWTM: 17.0 + 49.0° / 34.0 + 76.0°</p> <p>Efficiency: 84 %</p> <p>Peak intensity: 2.7 cd/lm</p> <p>LEDs/each optic: 1</p> <p>Light colour: White</p> <p>Required components:</p>	
<p>LUMINUS</p> <p>LED: SST-20</p> <p>FWHM / FWTM: 48.0 + 20.0° / 78.0 + 41.0°</p> <p>Efficiency: 81 %</p> <p>Peak intensity: 2.2 cd/lm</p> <p>LEDs/each optic: 1</p> <p>Light colour: White</p> <p>Required components:</p>	

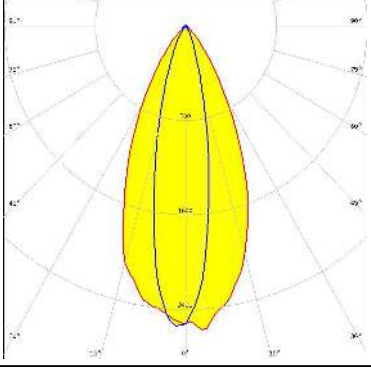
OPTICAL RESULTS (SIMULATED):

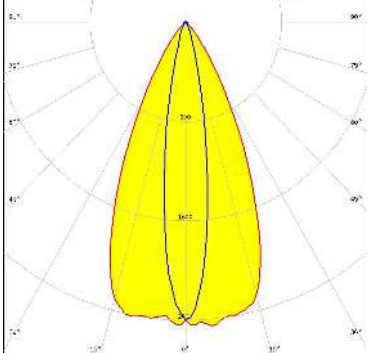
	<p>LED NVSxx19B/NVSxx19C FWHM / FWTM 25.0 + 45.0° / 52.0 + 81.0° Efficiency 78 % Peak intensity 1.8 cd/lm LEDs/each optic 1 Light colour White Required components:</p>	
	<p>LED Duris S5 (2 chip) FWHM / FWTM 20.0 + 45.0° / 40.0 + 75.0° Efficiency 80 % Peak intensity 2.1 cd/lm LEDs/each optic 1 Light colour White Required components:</p>	
	<p>LED Duris S5 (Single chip) FWHM / FWTM 19.0 + 45.0° / 40.0 + 75.0° Efficiency 79 % Peak intensity 2.1 cd/lm LEDs/each optic 1 Light colour White Required components:</p>	
	<p>LED OSCONIQ P 3030 FWHM / FWTM 50.0 + 17.0° / 75.0 + 34.0° Efficiency 79 % Peak intensity 2.5 cd/lm LEDs/each optic 1 Light colour White Required components:</p>	

OPTICAL RESULTS (SIMULATED):

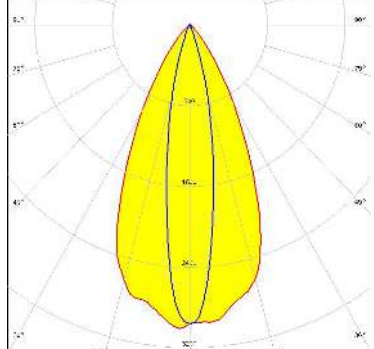
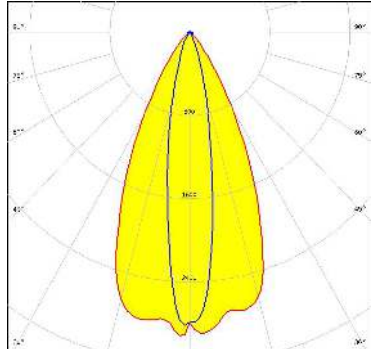
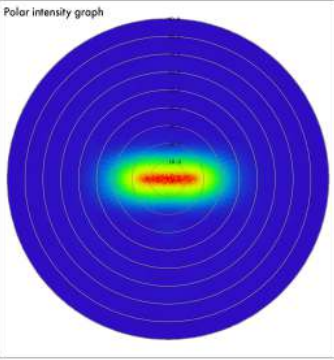
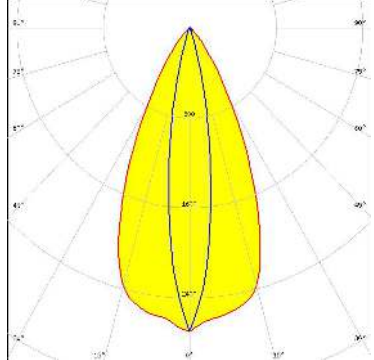
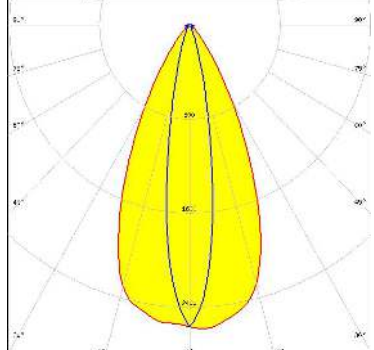
<p>OSRAM Opto Semiconductors</p> <p>LED OSLOM SSL 150</p> <p>FWHM / FWTM 16.5 + 48.0° / 36.0 + 76.0°</p> <p>Efficiency 83 %</p> <p>Peak intensity 2.8 cd/lm</p> <p>LEDs/each optic 1</p> <p>Light colour White</p> <p>Required components:</p>		
<p>OSRAM Opto Semiconductors</p> <p>LED OSLOM SSL 80</p> <p>FWHM / FWTM 16.0 + 45.0° / 38.0 + 72.0°</p> <p>Efficiency 81 %</p> <p>Peak intensity 2.8 cd/lm</p> <p>LEDs/each optic 1</p> <p>Light colour White</p> <p>Required components:</p>		
<p>OSRAM Opto Semiconductors</p> <p>LED SFH 4716S</p> <p>FWHM / FWTM 48.0 + 17.0° / 75.0 + 32.0°</p> <p>Efficiency 82 %</p> <p>LEDs/each optic 1</p> <p>Light colour IR</p> <p>Required components:</p>	<p>Polar intensity graph</p> 	
<p>OSRAM Opto Semiconductors</p> <p>LED SYNIOS S2222</p> <p>FWHM / FWTM 50.0 + 18.0° / 77.0 + 36.0°</p> <p>Efficiency 95 %</p> <p>Peak intensity 2.6 cd/lm</p> <p>LEDs/each optic 1</p> <p>Light colour White</p> <p>Required components:</p>		

OPTICAL RESULTS (SIMULATED):

SAMSUNG

LED LH351B
 FWHM / FWTM 44.0 + 24.0° / 80.0 + 48.0°
 Efficiency 81 %
 Peak intensity 2 cd/lm
 LEDs/each optic 1
 Light colour White
 Required components:

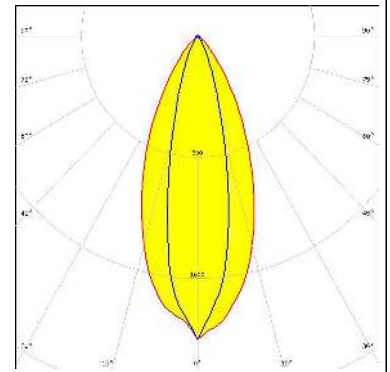

SAMSUNG

LED LM101B
 FWHM / FWTM 14.5 + 50.0° / 29.0 + 72.0°
 Efficiency 81 %
 Peak intensity 2.7 cd/lm
 LEDs/each optic 1
 Light colour White
 Required components:

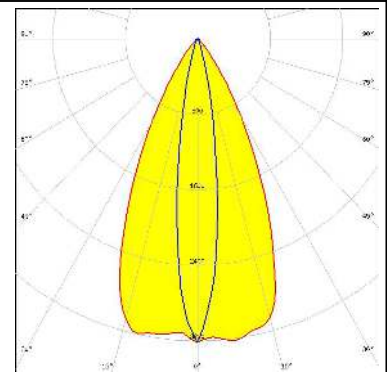

SAMSUNG

LED LM301A
 FWHM / FWTM 16.0 + 50.0° / 40.0 + 75.0°
 Efficiency 81 %
 Peak intensity 2.4 cd/lm
 LEDs/each optic 1
 Light colour White
 Required components:

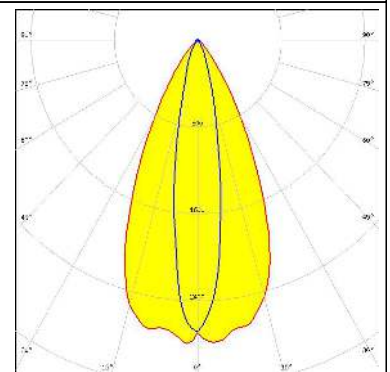





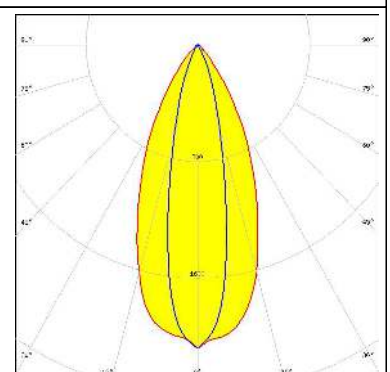

SEOL SEMICONDUCTOR

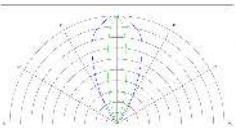
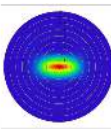
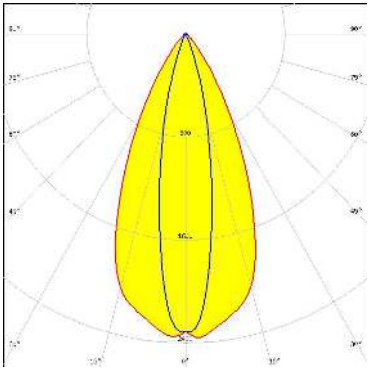
LED Z5M1/Z5M2
 FWHM / FWTM 46.0 + 22.0° / 80.0 + 47.0°
 Efficiency 83 %
 Peak intensity 2.1 cd/lm
 LEDs/each optic 1
 Light colour White
 Required components:

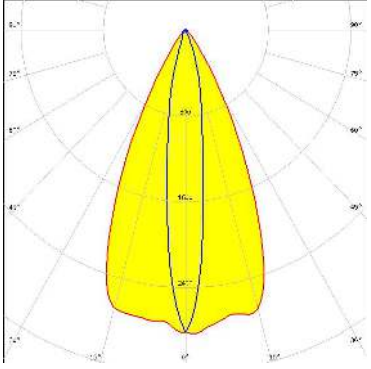

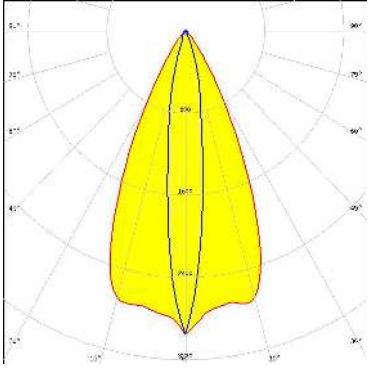
OPTICAL RESULTS (SIMULATED):

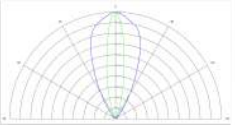
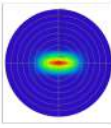
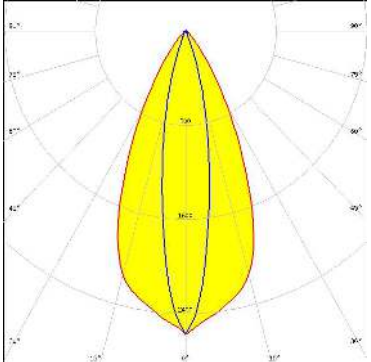
	<p>LED: FWR1108MS FWHM / FWTM: 48.0 + 20.0° / 76.0 + 40.0° Efficiency: 84 % LEDs/each optic: 1 Light colour: IR Required components:</p>			
	<p>LED: MFN1108MS FWHM / FWTM: 50.0 + 14.0° / 72.0 + 37.0° Efficiency: 84 % Peak intensity: 2.9 cd/lm LEDs/each optic: 1 Light colour: IR Required components:</p>			
	<p>LED: MGN1108MS FWHM / FWTM: 50.0 + 14.0° / 72.0 + 36.0° Efficiency: 84 % Peak intensity: 3 cd/lm LEDs/each optic: 1 Light colour: IR Required components:</p>			
	<p>LED: MJN1108MS FWHM / FWTM: 48.0 + 19.0° / 76.0 + 39.0° Efficiency: 85 % LEDs/each optic: 1 Light colour: IR Required components:</p>			

GENERAL INFORMATION:

NOTE: The typical beam angle will be changed by different color, chip size and chip position tolerance. The typical total beam angle is the full angle measured where the luminous intensity is half of the peak value.

MATERIALS:

As part of our continuous research and improvement processes, and to ensure the best possible quality and availability of our products, LEDiL reserves the right to change material grades without notice.

PRODUCT DATA USER AGREEMENT AND DISCLAIMER:

The measured data in the provided downloadable LEDiL Product Datasheets and Mechanical 2D-Drawings is rounded and provided as reference for planning. LEDiL Oy's optical specifications have been verified by conducting performance testing of the products in accordance with the company's quality system. The reported data are averaged results of multiple measurements with typical variation. LEDiL Oy reserves the right to without prior notification make changes and improvements to its products.

LEDiL Oy assumes neither warranty, nor guarantee nor any other liability of any kind for the contents and correctness of the provided data. The provided data has been generated with highest diligence but the provided data may in reality not represent the complete possible variation range of all intrinsic parameters. Therefore, in certain cases a deviation from the provided data could occur.

LEDiL Oy reserves the right to undertake technical changes of its products without further notification which could lead to changes in the provided data. LEDiL Oy assumes no liability of any kind for the possible deviation from any provided data or any other damage resulting from the usage of the provided data.

The user agrees to this disclaimer and user agreement with the download or usage of the provided files.

LEDiL Oy

Joensuunkatu 13
FI-24240 SALO
Finland

LEDiL Inc.

228 West Page Street
Suite D
Sycamore IL 60178
USA

Ledil Optics Technology (Shenzhen) Co., Ltd.

405 , Block B
Casic Motor Building
Shenzhen 518057
P.R.CHINA

Local sales and technical support

[www.ledil.com/
where_to_buy](http://www.ledil.com/where_to_buy)

Shipping locations

Salo, Finland
Hong Kong, China

Distribution Partners

[www.ledil.com/
where_to_buy](http://www.ledil.com/where_to_buy)