



RF360
Europe GmbH

SAW components

SAW RF filter
Short range devices

Series/type:	B4379
Ordering code:	B39921B4379P810
Date:	April 02, 2018
Version:	2.0

RF360 products mentioned within this document are products of RF360 Europe GmbH and other subsidiaries of RF360 Holdings Singapore Pte. Ltd. (collectively, the "RF360 Subsidiaries").

RF360 Europe GmbH, Anzinger Str. 13, München, Germany

© 2019 RF360 Europe GmbH and/or its affiliated companies. All rights reserved.

These materials, including the information contained herein, may be used only for informational purposes by the customer. The RF360 Subsidiaries assume no responsibility for errors or omissions in these materials or the information contained herein. The RF360 Subsidiaries reserve the right to make changes to the product(s) or information contained herein without notice. The materials and information are provided on an AS IS basis, and the RF360 Subsidiaries assume no liability and make no warranty or representation, either expressed or implied, with respect to the materials, or any output or results based on the use, application, or evaluation of such materials, including, without limitation, with respect to the non-infringement of trademarks, patents, copyrights or any other intellectual property rights or other rights of third parties.

No use of this documentation or any information contained herein grants any license, whether express, implied, by estoppel or otherwise, to any intellectual property rights, including, without limitation, to any patents owned by QUALCOMM Incorporated or any of its subsidiaries.

Not to be used, copied, reproduced, or modified in whole or in part, nor its contents revealed in any manner to others without the express written permission of RF360 Europe GmbH.

Qualcomm is a trademark of Qualcomm Incorporated, registered in the United States and other countries. Other product and brand names may be trademarks or registered trademarks of their respective owners.

This technical data may be subject to U.S. and international export, re-export, or transfer ("export") laws. Diversion contrary to U.S. and international law is strictly prohibited.

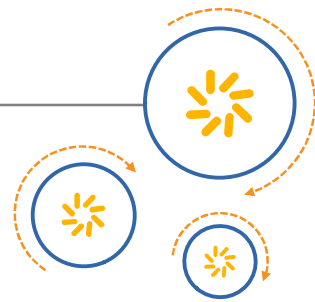

SAW components

SAW RF filter

Short range devices

Series/type:	B4379
Ordering code:	B39921B4379P810
Date:	April 02, 2018
Version:	2.0

RF360 products mentioned within this document are offered by RF360 Europe GmbH and other subsidiaries of RF360 Holdings Singapore Pte. Ltd. (collectively, the “RF360 Subsidiaries”).

RF360 Holdings Singapore Pte. Ltd. is a joint venture of Qualcomm Global Trading Pte. Ltd. and EPCOS AG.

RF360 Europe GmbH, Anzinger Str. 13, München, Germany

© 2018 RF360 Europe GmbH and/or its affiliated companies. All rights reserved.

SAW components**B4379****SAW RF filter****915.0 MHz**

Data sheet

These materials, including the information contained herein, may be used only for informational purposes by the customer. The RF360 Subsidiaries assume no responsibility for errors or omissions in these materials or the information contained herein. The RF360 Subsidiaries reserve the right to make changes to the product(s) or information contained herein without notice. The materials and information are provided on an AS IS basis, and the RF360 Subsidiaries assume no liability and make no warranty or representation, either expressed or implied, with respect to the materials, or any output or results based on the use, application, or evaluation of such materials, including, without limitation, with respect to the non-infringement of trademarks, patents, copyrights or any other intellectual property rights or other rights of third parties.

No use of this documentation or any information contained herein grants any license, whether express, implied, by estoppel or otherwise, to any intellectual property rights, including, without limitation, to any patents owned by QUALCOMM Incorporated or any of its subsidiaries.

Not to be used, copied, reproduced, or modified in whole or in part, nor its contents revealed in any manner to others without the express written permission of RF360 Europe GmbH.

Qualcomm and Qualcomm RF360 are trademarks of Qualcomm Incorporated, registered in the United States and other countries. RF360 is a trademark of Qualcomm Incorporated. Other product and brand names may be trademarks or registered trademarks of their respective owners.

This technical data may be subject to U.S. and international export, re-export, or transfer (“export”) laws. Diversion contrary to U.S. and international law is strictly prohibited.

SAW components

B4379

SAW RF filter

915.0 MHz

Data sheet

Table of contents

1	Application	4
2	Features	4
3	Package	5
4	Pin configuration	5
5	Matching circuit	6
6	Characteristics	7
7	Maximum ratings	8
8	Transmission coefficient	9
9	Packing material	10
10	Marking	13
11	Soldering profile	14
12	ESD protection of SAW filters	15
13	Annotations	16
14	Cautions and warnings	17
	Important notes	18

SAW components**B4379****SAW RF filter****915.0 MHz**

Data sheet

1 Application

- Low-loss RF filter for remote control receivers
- No matching network required for operation at 50 Ω

2 Features

- Package size 1.1±0.1 mm × 0.9±0.1 mm
- Package height 0.45 mm (max.)
- Approximate weight 2 mg
- RoHS compatible
- Package for Surface Mount Technology (SMT)
- Ni/Au-plated terminals
- Filter surface passivated
- Electrostatic Sensitive Device (ESD)
- Moisture Sensitivity Level 2a (MSL2a)
- AEC-Q200 qualified component family (Grade 1: -40 °C to +125 °C)

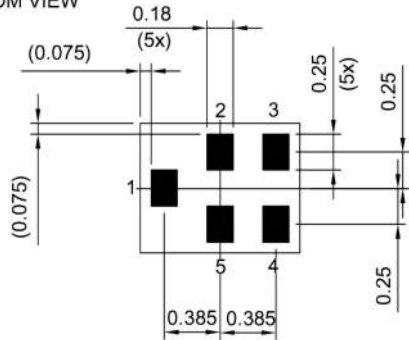

Figure 1: Picture of component with example of product marking.

Data sheet

3 Package

BOTTOM VIEW



Pad and pitch tolerance ±0.05

4 Pin configuration

- 1 Input
- 4 Output
- 2, 3, 5 Ground

SIDE VIEW

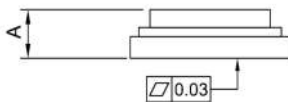

TOP VIEW

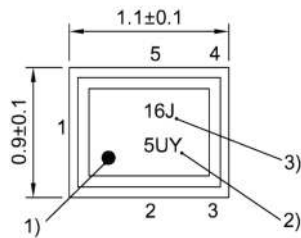

- 1) Marking for pad number 1
- 2) Example of encoded lot number
- 3) Example of encoded filter type number

Land pattern THRU VIEW

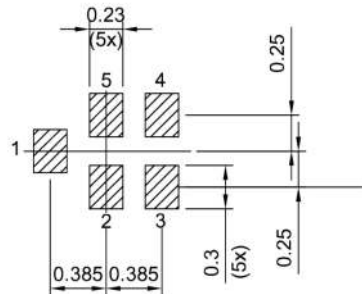

Landing pad tolerance -0.02

Figure 2: Drawing of package with package height A = 0.45 mm (max.). See Sec. Package information (p. 17).

Data sheet

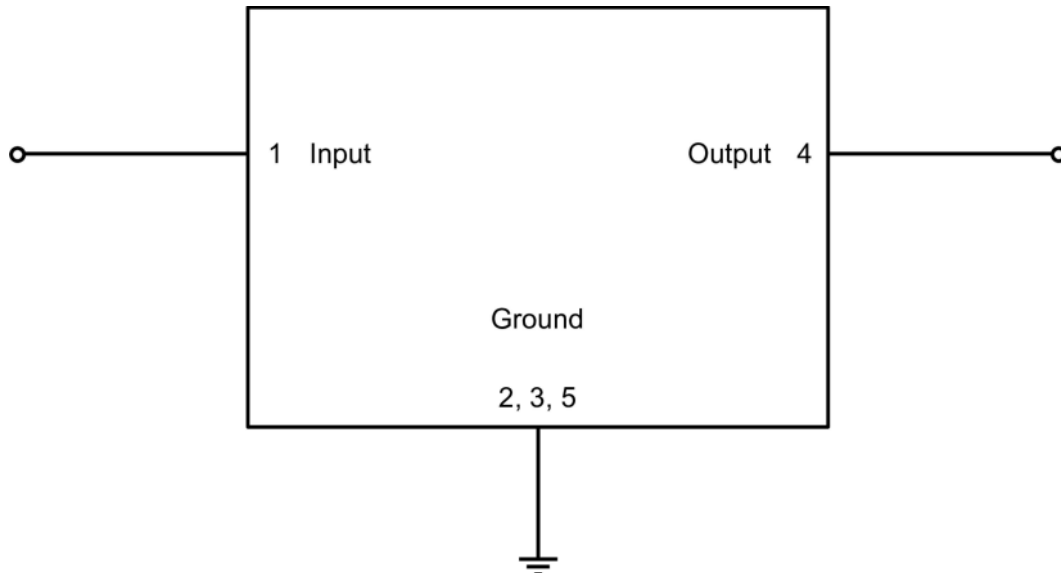
5 Matching circuit**Figure 3:** Schematic of matching circuit. No external matching components required.

SAW components

B4379

SAW RF filter

915.0 MHz

Data sheet

6 Characteristics

Temperature range for specification

$$T_{\text{SPEC}} = -40\text{ °C} \dots +85\text{ °C}$$

Input terminating impedance

$$Z_{\text{IN}} = 50\ \Omega$$

Output terminating impedance

$$Z_{\text{OUT}} = 50\ \Omega$$

Characteristics		min. for T_{SPEC}	typ. @ +25 °C	max. for T_{SPEC}	
Center frequency		—	915	—	MHz
Maximum insertion attenuation					
	902 ... 928 MHz	—	1.9	2.3	dB
Amplitude ripple (p-p)					
	902 ... 928 MHz	—	0.7	1.4	dB
Minimum attenuation					
	50 ... 800 MHz	37	40	—	dB
	800 ... 845 MHz	37	42	—	dB
	845 ... 880 MHz	37	40	—	dB
	947 ... 970 MHz	18	34	—	dB
	970 ... 1020 MHz	33	40	—	dB
	1020 ... 1200 MHz	33	39	—	dB

SAW components

B4379

SAW RF filter

915.0 MHz

Data sheet

7 Maximum ratings

Operable temperature	$T_{OP} = -40\text{ °C} \dots +125\text{ °C}$	
Storage temperature	$T_{STG}^{1)} = -40\text{ °C} \dots +125\text{ °C}$	
DC voltage	$ V_{DC} ^{2)} = 0\text{ V}$	
Input power @ input port: 902 ... 928 MHz	$P_{IN} = 10\text{ dBm}$	Continuous wave for 100000 h @ 50 °C.

¹⁾ Not valid for packaging material. Storage temperature for packaging material is -25 °C to +40 °C.

²⁾ In case of applied DC voltage blocking capacitors are mandatory.

Data sheet

8 Transmission coefficient

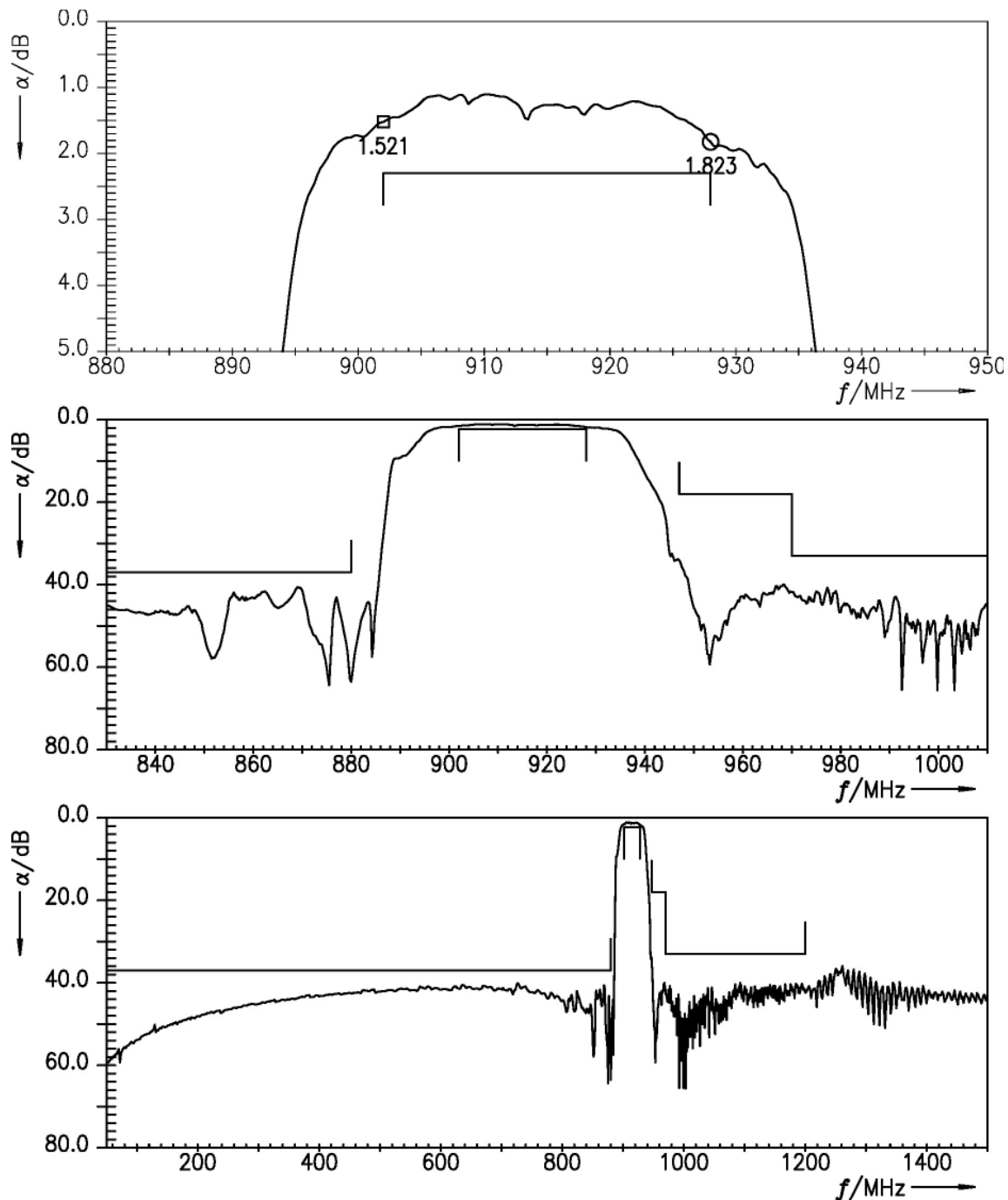

Figure 4: Attenuation.

SAW components

B4379

SAW RF filter

915.0 MHz

Data sheet

9 Packing material

9.1 Tape

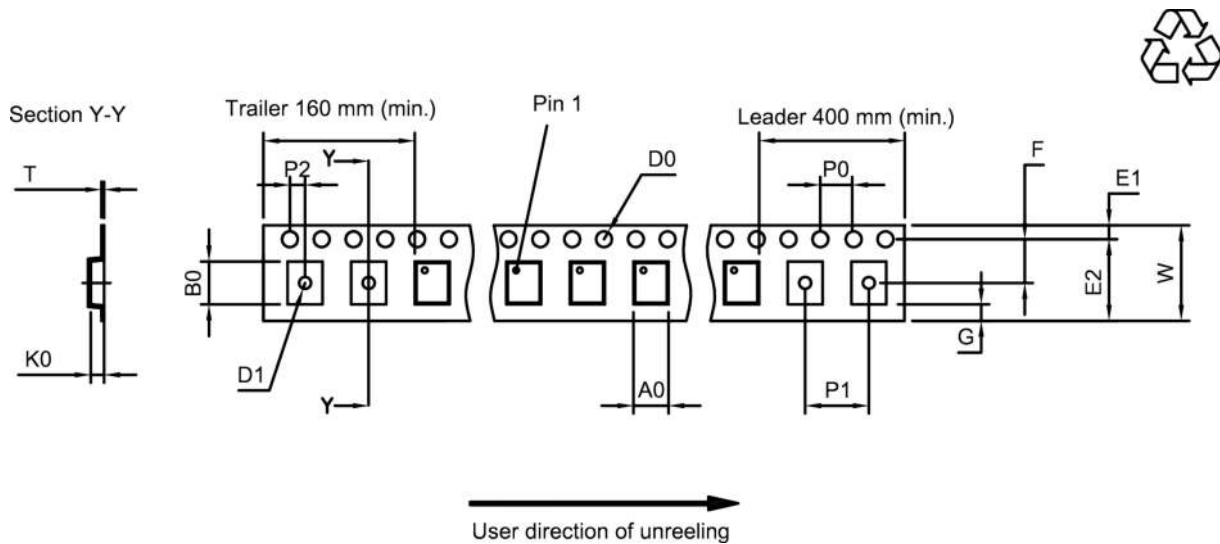

Figure 5: Drawing of tape (first-angle projection) with tape dimensions according to Table 1.

A_0	1.02±0.05 mm	E_2	6.25 mm (min.)	P_1	2.0±0.1 mm
B_0	1.22±0.05 mm	F	3.5±0.05 mm	P_2	2.0±0.05 mm
D_0	1.55±0.05 mm	G	–	T	0.25±0.03 mm
D_1	0.55±0.1 mm	K_0	0.6±0.05 mm	W	8.0+0.3/-0.1 mm
E_1	1.75±0.1 mm	P_0	4.0±0.1 mm		

Table 1: Tape dimensions.

Data sheet

9.2 Reel with diameter of 180 mm

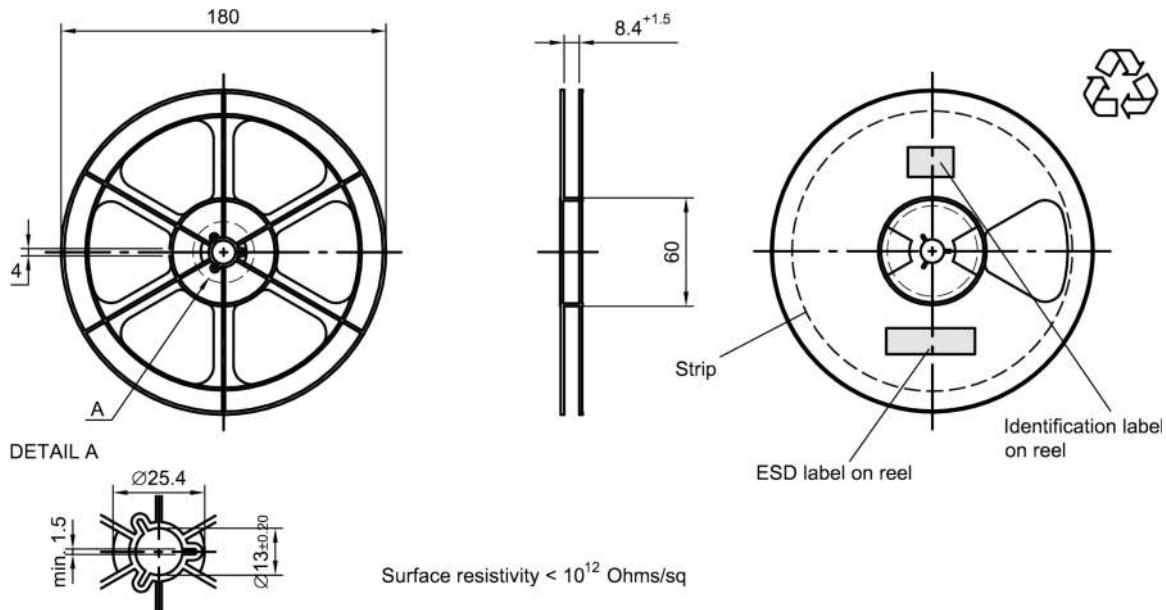

Figure 6: Drawing of reel (first-angle projection) with diameter of 180 mm.

Dimensions [mm]

X = 220+5

Y = 235+5

Sealing area 10±3

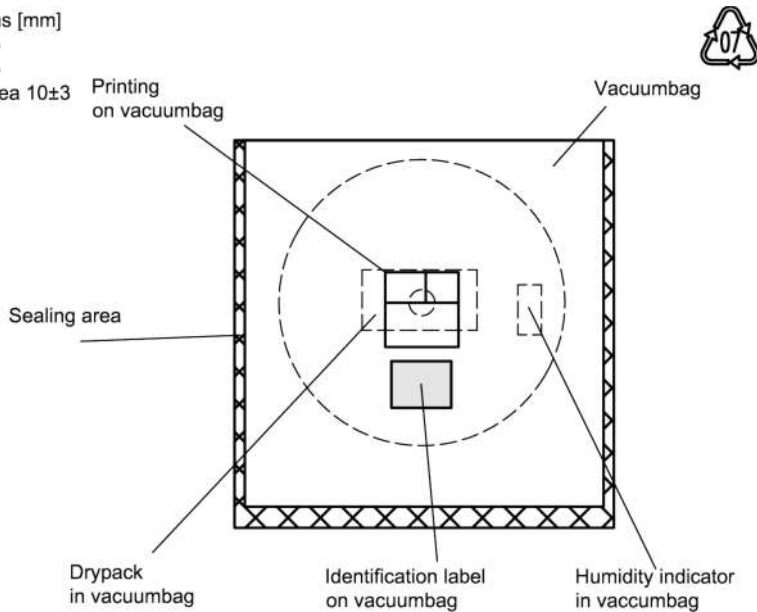

Figure 7: Drawing of moisture barrier bag (MBB) for reel with diameter of 180 mm.

SAW components

B4379

SAW RF filter

915.0 MHz

Data sheet

Dimensions [mm]

L = 188

B = 188

H = 30

Tolerance ± 5 

Figure 8: Drawing of folding box for reel with diameter of 180 mm.

SAW components

B4379

SAW RF filter

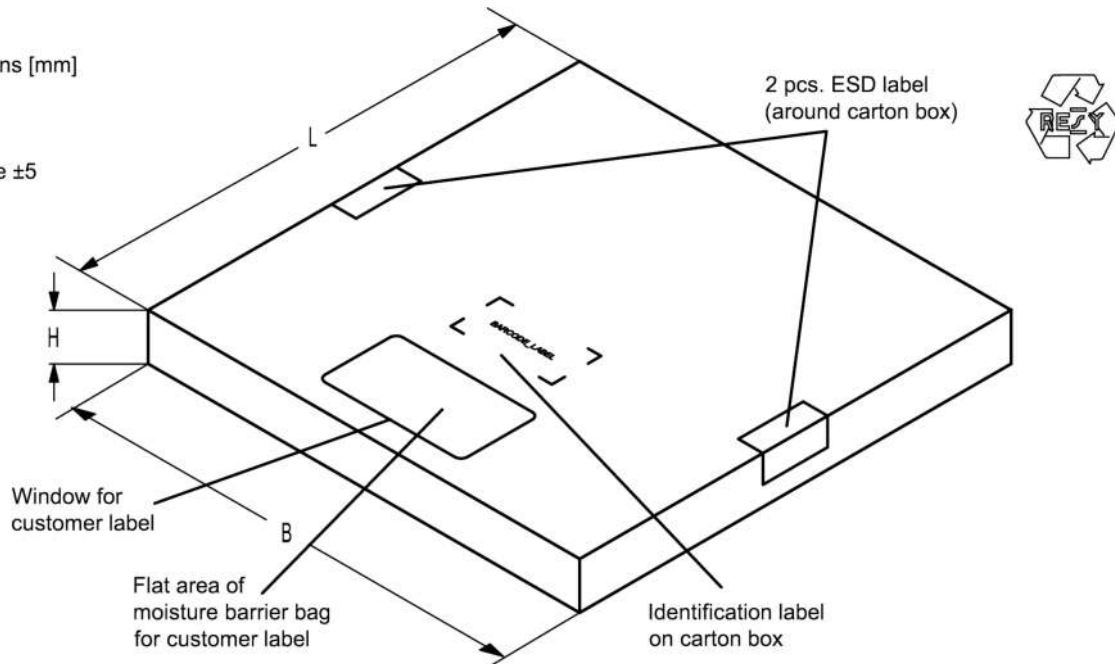
915.0 MHz

Data sheet

10 Marking

Products are marked with product type number and lot number encoded according to Table 2:

■ Type number:

The 4 digit type number of the ordering code, e.g., B3xxxxB**1234**xxxx, is encoded by a special BASE32 code into a 3 digit marking.

Example of decoding type number marking on device in decimal code.
16J => **1234**
 $1 \times 32^2 + 6 \times 32^1 + 18 (=J) \times 32^0 =$ **1234**

The BASE32 code for product type B4379 is 48V.

■ Lot number:

The last 5 digits of the lot number, e.g., **12345**, are encoded based on a special BASE47 code into a 3 digit marking.

Example of decoding lot number marking on device in decimal code.
5UY => **12345**
 $5 \times 47^2 + 27 (=U) \times 47^1 + 31 (=Y) \times 47^0 =$ **12345**

Adopted BASE32 code for type number			
Decimal value	Base32 code	Decimal value	Base32 code
0	0	16	G
1	1	17	H
2	2	18	J
3	3	19	K
4	4	20	M
5	5	21	N
6	6	22	P
7	7	23	Q
8	8	24	R
9	9	25	S
10	A	26	T
11	B	27	V
12	C	28	W
13	D	29	X
14	E	30	Y
15	F	31	Z

Adopted BASE47 code for lot number			
Decimal value	Base47 code	Decimal value	Base47 code
0	0	24	R
1	1	25	S
2	2	26	T
3	3	27	U
4	4	28	V
5	5	29	W
6	6	30	X
7	7	31	Y
8	8	32	Z
9	9	33	b
10	A	34	d
11	B	35	f
12	C	36	h
13	D	37	n
14	E	38	r
15	F	39	t
16	G	40	v
17	H	41	\
18	J	42	?
19	K	43	{
20	L	44	}
21	M	45	<
22	N	46	>
23	P		

Table 2: Lists for encoding and decoding of marking.

SAW components

B4379

SAW RF filter

915.0 MHz

Data sheet

11 Soldering profile

The recommended soldering process is in accordance with IEC 60068-2-58 – 3rd edit and IPC/JEDEC J-STD-020B.

ramp rate	≤ 3 K/s
preheat	125 °C to 220 °C, 150 s to 210 s, 0.4 K/s to 1.0 K/s
$T > 220$ °C	30 s to 70 s
$T > 230$ °C	min. 10 s
$T > 245$ °C	max. 20 s
$T \geq 255$ °C	–
peak temperature T_{peak}	250 °C +0/-5 °C
wetting temperature T_{min}	230 °C +5/-0 °C for 10 s ± 1 s
cooling rate	≤ 3 K/s
soldering temperature T	measured at solder pads

Table 3: Characteristics of recommended soldering profile for lead-free solder (Sn95.5Ag3.8Cu0.7).

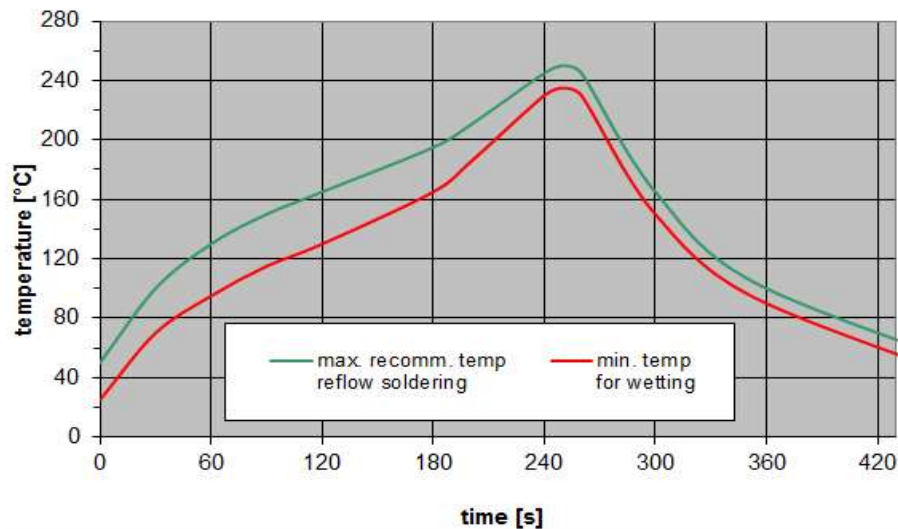

Figure 9: Recommended reflow profile for convection and infrared soldering – lead-free solder.

Data sheet

12 ESD protection of SAW filters

SAW filters are **E**lectro **S**tatic **D**ischarge sensitive devices. To reduce the probability of damages caused by ESD, special matching topologies have to be applied.

In general, “ESD matching” has to be ensured at that filter port, where electrostatic discharge is expected.

Electrostatic discharges predominantly appear at the antenna input of RF receivers. Therefore, only the input matching of the SAW filter has to be designed to short circuit or to block the ESD pulse.

Below three figures show recommended “ESD matching” topologies.

For wide band filters the high-pass ESD matching structure needs to be at least of 3rd order to ensure a proper matching for any impedance value of antenna and SAW filter input. The required component values have to be determined from case to case.

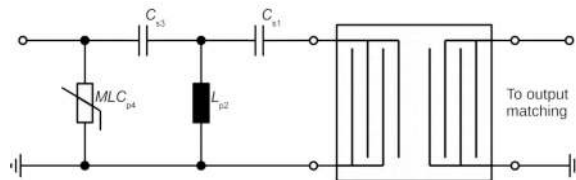

Figure 10: MLC varistor plus ESD matching.

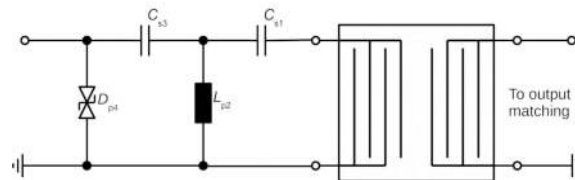

Figure 11: Suppressor diode plus ESD matching.

In cases where minor ESD occur, following simplified “ESD matching” topologies can be used alternatively.

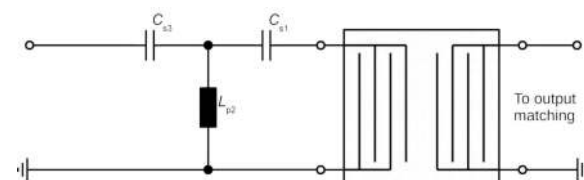

Figure 12: 3rd order high-pass structure for basic ESD protection.

In all three figures the shunt inductor L_{p2} could be replaced by a shorted microstrip with proper length and width. If this configuration is possible depends on the operating frequency and available PCB space.

Effectiveness of the applied ESD protection has to be checked according to relevant industry standards or customer specific requirements.

For further information, please refer to RF360 Application report: “**ESD protection for SAW filters**”. This report can be found under www.rf360jv.com/rke. Click on “Applications Notes”.

SAW components**B4379****SAW RF filter****915.0 MHz**

Data sheet

13 Annotations

13.1 Matching coils

See TDK inductor pdf-catalog <http://www.tdk.co.jp/tefe02/coil.htm#aname1> and Data Library for circuit simulation <http://www.tdk.co.jp/etvcl/index.htm>.

13.2 RoHS compatibility

ROHS-compatible means that products are compatible with the requirements according to Art. 4 (substance restrictions) of Directive 2011/65/EU of the European Parliament and of the Council of June 8th, 2011, on the restriction of the use of certain hazardous substances in electrical and electronic equipment ("Directive") with due regard to the application of exemptions as per Annex III of the Directive in certain cases.

13.3 Scattering parameters (S-parameters)

The pin/port assignment is available in the headers of the S-parameter files. Please contact your local RF360 sales office.

Data sheet

14 Cautions and warnings

14.1 Display of ordering codes for RF360 products

The ordering code for one and the same product can be represented differently in data sheets, data books, other publications and the website of RF360, or in order-related documents such as shipping notes, order confirmations and product labels. The varying representations of the ordering codes are due to different processes employed and do not affect the specifications of the respective products. Detailed information can be found on the Internet under www.rf360jv.com/orderingcodes.

14.2 Material information

Due to technical requirements components may contain dangerous substances. For information on the type in question please also contact one of our sales offices.

For information on recycling of tapes and reels please contact one of our sales offices.

14.3 Moldability

Before using in overmolding environment, please contact your local RF360 sales office.

14.4 Package information

Landing area

The printed circuit board (PCB) land pattern (landing area) shown is based on RF360 internal development and empirical data and illustrated for example purposes, only. As customers' SMD assembly processes may have a plenty of variants and influence factors which are not under control or knowledge of RF360, additional careful process development on customer side is necessary and strongly recommended in order to achieve best soldering results tailored to the particular customer needs.

Dimensions

Unless otherwise specified all dimensions are understood using unit millimeter (mm).

Dimensions do not include burrs.

Projection method

Unless otherwise specified first-angle projection is applied.

Important notes

The following applies to all products named in this publication:

1. Some parts of this publication contain **statements about the suitability of our products for certain areas of application**. These statements are based on our knowledge of typical requirements that are often placed on our products in the areas of application concerned. We nevertheless expressly point out **that such statements cannot be regarded as binding statements about the suitability of our products for a particular customer application**. As a rule, RF360 Europe GmbH and its affiliates are either unfamiliar with individual customer applications or less familiar with them than the customers themselves. For these reasons, it is always ultimately incumbent on the customer to check and decide whether an RF360 product with the properties described in the product specification is suitable for use in a particular customer application.
2. We also point out that **in individual cases, a malfunction of electronic components or failure before the end of their usual service life cannot be completely ruled out in the current state of the art, even if they are operated as specified**. In customer applications requiring a very high level of operational safety and especially in customer applications in which the malfunction or failure of an electronic component could endanger human life or health (e.g. in accident prevention or life-saving systems), it must therefore be ensured by means of suitable design of the customer application or other action taken by the customer (e.g. installation of protective circuitry or redundancy) that no injury or damage is sustained by third parties in the event of malfunction or failure of an electronic component.
3. **The warnings, cautions and product-specific notes must be observed.**
4. In order to satisfy certain technical requirements, **some of the products described in this publication may contain substances subject to restrictions in certain jurisdictions (e.g. because they are classed as hazardous)**. Useful information on this will be found in our Material Data Sheets on the Internet (www.rf360jv.com/material). Should you have any more detailed questions, please contact our sales offices.
5. We constantly strive to improve our products. Consequently, **the products described in this publication may change from time to time**. The same is true of the corresponding product specifications. Please check therefore to what extent product descriptions and specifications contained in this publication are still applicable before or when you place an order. We also **reserve the right to discontinue production and delivery of products**. Consequently, we cannot guarantee that all products named in this publication will always be available.
The aforementioned does not apply in the case of individual agreements deviating from the foregoing for customer-specific products.